

www.avilignmed.com

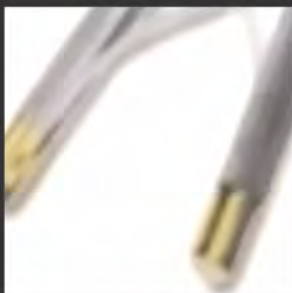

General Surgery
Instruments
Catalog

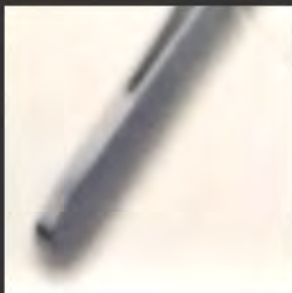

General Surgery

Instruments Catalogue

AVILIGN Medical

56-A Small Industrial Estate
Sialkot 51310, Pakistan.

Phone : +92 52 3258334

Fax : +92 52 3555108

Email : info@avilignmed.com

Website : www.avilignmed.com

AVILIGN Instruments is a pure instrument manufacturer of the highest quality using German forgings. We are using most advanced machining process and quality control system. Since the foundation of company, our claim has remained unchanged.

AVILIGN is a family owned and operated business, dedicated to provide healthcare professionals with the instruments, they need to perform their art. AVILIGN has been serving the industry for over 70 years.

Mr. Yaqub Ahmed; the founder and acting chairman had his training for manufacturing techniques from USA and Tuttlingen – Germany. His son and current acting director, Mr. Salman Ahmed joined the family business almost 20 years ago.

AVILIGN is committed to provide a product line that guarantees quality and extraordinary value its user. This satisfaction and cooperation has become a hallmark of our instruments. All the instruments are made with best quality materials, imported from Germany. These instruments are carried as **100% German** manufactured. we strive to match or exceed the requirements and expectations of our clients. We pledge to provide you with the finest in materials, craftsmanship and value available in our industry. As a matter of fact, we guarantee it.

We have a team of highly skilled, experienced and dedicated craftsmen and the most modern, state of the art factory in the region. We invest in the latest German polishing, Grinding, Heat treatment, Laser Welding, Laser Marking machines to ensure that our instruments can hold their own with even the priciest branded lines.

Instrument manufacturing process at AVILIGN follows the German documentation, very strictly. Each instrument must pass all prescribed and documented tests during its manufacturing cycle. Each instrument travels through its manufacturing process with written test instructions and technical drawing against which the manufacturing batch is checked. Every step of this process is documented, very carefully. Only instruments those passes their quality tests, are marked, cleaned and then released for packing and storage.

As we are convinced of the high quality of our surgical instruments, we offer our customers an unlimited warranty if our instrument exhibit a defect in material or workmanship despite our highly careful inspection and testing.

AVILIGN works with world's top most quality selling companies and is committed to keep its quality and craftsmanship for the years coming ahead.

Diagnostics	1-2
Scalpels & Scalpel Handles	3-8
Dermatology	9-10
Probes	11-14
Trocars & Suction Tubes	15-20
Scissors	21-62
Scissors With Tungsten Carbide Inserts	43-62
Forceps	63-80
Forceps With Tungsten Carbide Inserts	81-86
Artery Forceps	87-128
Retractors	129-156
Needle Holders	157-176
Needle Holders With Tungsten Carbide Inserts	167-176
ENT Instruments	177-198
Micro Instruments	199-212
Thorax & Lungs	213-220
Cardiovascular Surgery	221-224
Stomach Intestines & Rectum	225-232
Liver, Gall Bladder & Kidney	233-238
Gynaecology & Obstetrics	239-262
Urology	263-268
Bone Surgery	269-332
Hands & Foot Surgery	333-336
Plaster & Dressing Instruments	337-342
Ward Instruments	343-344
Stainless Steel Holloware	345-352



01

Diagnosics

Diagnostik
Diagnóstico
Diagnostica



Taylor
 01-0010-17 17 cm / 6¾"
 01-0010-20 20 cm / 8"



Rabiner
 01-0020-23
 23 cm / 9"



Babinsky
 01-0030-22
 22 cm / 8¾"



Pinard
 01-0040-18
 18 cm / 7"
 Wooden



Pinard
 01-0050-15
 15 cm / 6"



02

Scalpel Handles

Skalpellgriffe
Mangos de bisturíes
Manici per bisturi



02-0010-21
21 cm / 8¼"
No. 3L



02-0020-21
21 cm / 8¼"
No. 4L



02-0030-13
13.5 cm / 5¼"
No. 4



02-0040-14
14.5 cm / 5¾"
No. 3

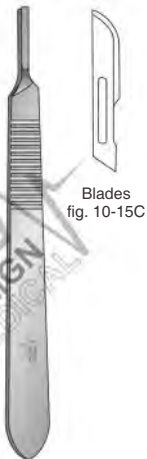

02-0050-12
12 cm / 4¾"
No. 3

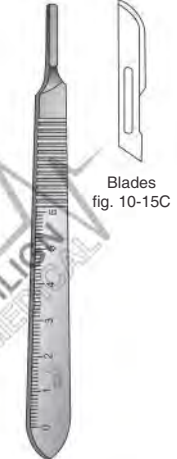

02-0060-12
12 cm / 4¾"
No. 3

Skalpellgriffe, Klängenbrecher
 Mangos de bisturíes, Rompe-hojas de afeitár
 Manici per bisturi, Pinze per afferrare e rompere le lamette de rasoio
 Scalpel Handles, Blade Breakers



02-0070-21
 21.5 cm / 8½"
 No. 4

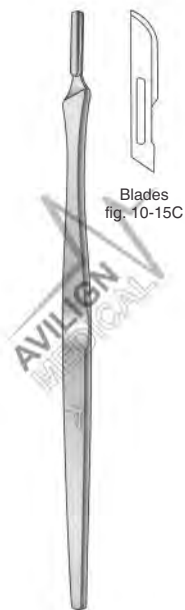

02-0080-16
 16 cm / 6¼"
 No. 4



02-0090-16
 16 cm / 6¼"
 No. 7



Castroviejo
 02-0100-12 12 cm / 4½"
 02-0100-13 13 cm / 5¼"

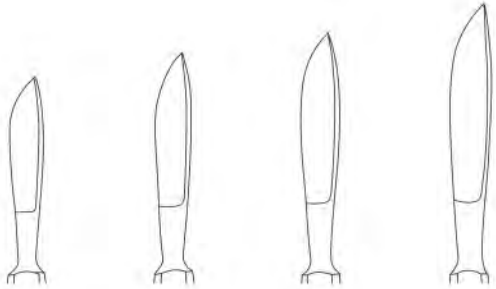

02-0110-01 Fig. 1 02-0110-02 Fig. 2 02-0110-03 Fig. 3 02-0110-04 Fig. 4

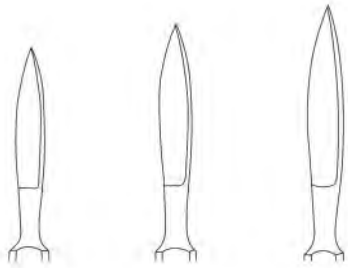

02-0110-05 Fig. 5 02-0110-06 Fig. 6 02-0110-07 Fig. 7

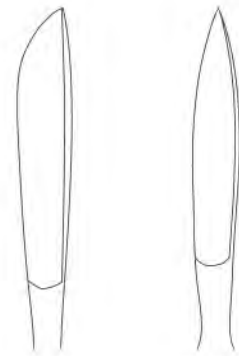

02-0120-01 Fig. 1 02-0120-02 Fig. 2



Graefe
13 cm / 5"



Bergmann
14 cm / 5½"

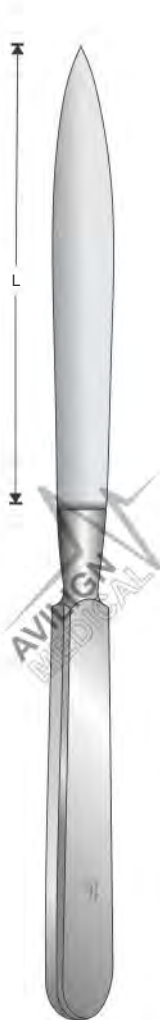

Liston
02-0130-13 13 cm / 5"
02-0130-16 16 cm / 6¼"
02-0130-19 19 cm / 7½"
02-0130-22 22 cm / 8¾"
02-0130-28 28 cm / 11"
Amputating Knives

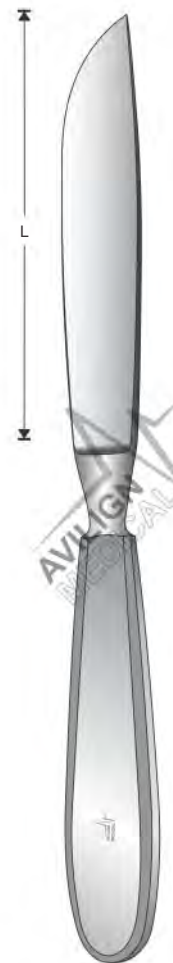

Langenbeck
02-0140-12
13 cm / 5"
Amputating Knives



Watson
02-0150-30
30 cm / 11¾"



02-0150-99
Spare Blade
0.1 - 1.5 mm
Max. 160 mm



03

Dermatology

Dermatologie
Dermatologia
Dermotologia

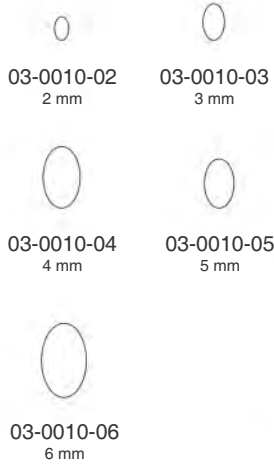

Fox
14 cm / 5½"
Lupus Curettes

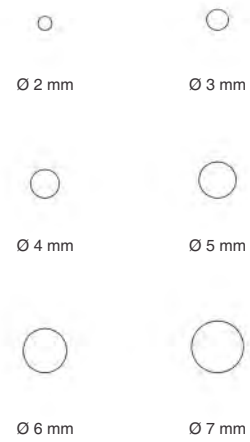

03-0020-00
Ø 2.0 - 7.0 mm
Dermal Punch Set



Unna
03-0030-14
14.5 cm / 5¾"
Comedone Extractor



Unna
03-0040-14
14.5 cm / 5¾"
Comedone Extractor



Saalfeld
03-0050-11
11 cm / 4¼"
Comedone Extractor



04

Probes

Sonden
Sondas
Sonde



04-0010-11 11.5 cm / 4½"
 04-0010-13 13 cm / 5"
 04-0010-14 14.5 cm / 5¾"
 04-0010-16 16 cm / 6¼"
 04-0010-18 18 cm / 7"
 04-0010-20 20 cm / 8"
 04-0010-25 25 cm / 9¾"



04-0020-11 11.5 cm / 4½"
 04-0020-13 13 cm / 5"
 04-0020-14 14.5 cm / 5¾"
 04-0020-16 16 cm / 6¼"
 04-0020-18 18 cm / 7"
 04-0020-20 20 cm / 8"
 04-0020-25 25 cm / 9¾"



04-0030-11 11.5 cm / 4½"
 04-0030-13 13 cm / 5"
 04-0030-14 14.5 cm / 5¾"
 04-0030-16 16 cm / 6¼"
 04-0030-18 18 cm / 7"
 04-0030-20 20 cm / 8"
 04-0030-25 25 cm / 9¾"
 04-0030-30 30 cm / 11¾"



04-0040-11 11.5 cm / 4½"
 04-0040-13 13 cm / 5"
 04-0040-14 14.5 cm / 5¾"
 04-0040-16 16 cm / 6¼"
 04-0040-18 18 cm / 7"
 04-0040-20 20 cm / 8"
 With Eye

Knopfsonden, Tränenkanalsonden
 Soundas abotonadas, Estilete para el canal lacrimal
 Sonde buttonute, Stilette per canale lacrimale
 Probes, Lachrymal Probes



- 04-0050-13 13 cm / 5"
 - 04-0050-14 14.5 cm / 5¾"
 - 04-0050-16 16 cm / 6¼"
 - 04-0050-18 18 cm / 7"
 - 04-0050-20 20 cm / 8"
- Myrtle Leaf Probes



Stacke
 04-0060-10
 10.5 cm / 4¼"
 Silver



Bowman
 04-0070-00 Fig. 000/00
 04-0070-01 Fig. 00/0
 04-0070-02 Fig. 1/2
 04-0070-03 Fig. 3/4
 04-0070-04 Fig. 5/6
 04-0070-05 Fig. 7/8
 Lachrymal Probes
 Silver



04-0080-19
19 cm / 7½"
Malleable



04-0090-19
19 cm / 7½"
Malleable



04-0100-11 11.5 cm / 4½"
04-0100-13 13 cm / 5"
04-0100-14 14.5 cm / 5¾"
04-0100-16 16 cm / 6¼"
04-0100-18 18 cm / 7"
04-0100-20 20.5 cm / 8"
Directors



04-0110-11 11.5 cm / 4½"
04-0110-13 13 cm / 5"
04-0110-14 14.5 cm / 5¾"
04-0110-16 16 cm / 6¼"
04-0110-18 18 cm / 7"
Directors



Doyen
04-0120-14
14.5 cm / 5¾"
Directors



Nelaton
04-0130-16
16 cm / 6¼"
Directors



05

Trocars, Suction Tubes

Trokare, Saugrohre
Trókares, Tubos para aspiración
Trequarti, Tubi aspirazione



Farrell
05-0010-12 Ø 0.9 x 12 cm
05-0010-14 Ø 0.9 x 14 cm
05-0010-16 Ø 1.1 x 16 cm
05-0010-18 Ø 1.2 x 18 cm
Triangular Serrated



Farrell
05-0020-12 Ø 0.9 x 12 cm
05-0020-14 Ø 0.9 x 14 cm
05-0020-16 Ø 1.1 x 16 cm
05-0020-18 Ø 1.2 x 18 cm
Spirally Serrated



Jobson-Horne
05-0030-14 Ø 1.5 x 14 cm
05-0030-18 Ø 1.5 x 18 cm
Serrated

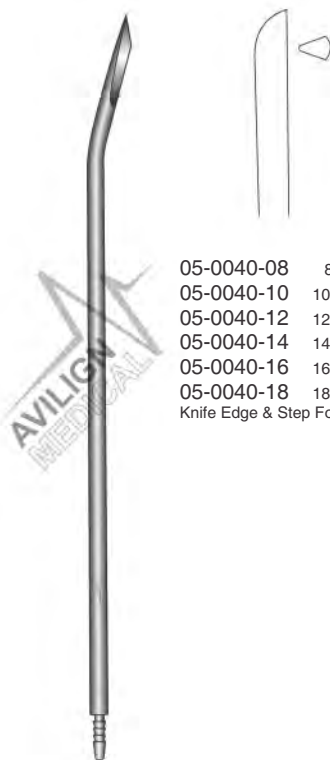

05-0040-08 8 Charr
05-0040-10 10 Charr
05-0040-12 12 Charr
05-0040-14 14 Charr
05-0040-16 16 Charr
05-0040-18 18 Charr
Knife Edge & Step Formation

Redon
19.5 cm / 7¾"



05-0050-08 8 Charr
05-0050-10 10 Charr
05-0050-12 12 Charr
05-0050-14 14 Charr
05-0050-16 16 Charr
05-0050-18 18 Charr
Knife Edge & Step Formation

Redon
16 cm / 6¼"



- 05-0060-03 Ø 3 mm
- 05-0060-04 Ø 4 mm
- 05-0060-05 Ø 5 mm
- 05-0060-06 Ø 6 mm
- 05-0060-07 Ø 7 mm
- 05-0060-08 Ø 8 mm
- 05-0060-09 Ø 9 mm
- 05-0060-10 Ø 10 mm
- 05-0060-12 Ø 12 mm

Nelson
21 cm / 8¼"

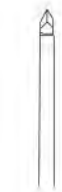

Ø 1.75 mm



Ø 3.0 mm



Ø 4.5 mm



Universal
05-0070-14
14 cm / 5½"
Complete



Ø 1.75 mm



Ø 3.0 mm



Ø 4.5 mm



Ø 6.0 mm



Universal
05-0080-14
14 cm / 5½"
Complete

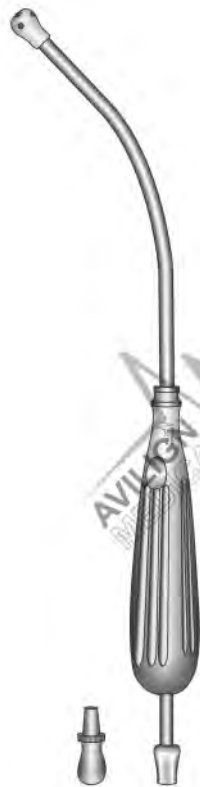
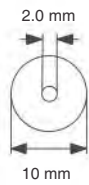

Yankauer
05-0090-02
27 cm / 10¾"



Baby-Yankauer
05-0100-03
21 cm / 8¼"



Frazier
 05-0110-05 5 Charr.
 05-0110-07 7 Charr.
 05-0110-09 9 Charr.
 Graduated



Frazier
 05-0120-06 6 Charr.
 05-0120-07 7 Charr.
 05-0120-08 8 Charr.
 05-0120-09 9 Charr.
 05-0120-10 10 Charr.
 05-0120-11 11 Charr.
 05-0120-12 12 Charr.
 05-0120-15 15 Charr.



Adson
 05-0130-04 Ø 4 mm
 05-0130-05 Ø 5 mm

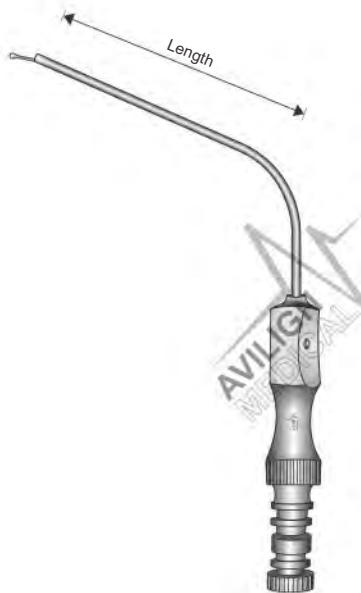

Ferguson
 90°

Diameter Ø	Length 110 mm	Length 130 mm	Length 160 mm	Length 200 mm
4 Charr.	05-0140-04			
5 Charr.	05-0140-05	05-0150-05	05-0160-05	05-0170-05
6 Charr.	05-0140-06	05-0150-06	05-0160-06	05-0170-06
7 Charr.	05-0140-07			
8 Charr.	05-0140-08	05-0150-08	05-0160-08	05-0170-08
9 Charr.	05-0140-09	05-0150-09	05-0160-09	05-0170-09
10 Charr.	05-0140-10			
11 Charr.	05-0140-11			
12 Charr.	05-0140-12	05-0150-12	05-0160-12	05-0170-12
15 Charr.	05-0140-15	05-0150-15	05-0160-15	05-0170-15



05-0180-10

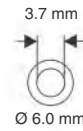

05-0190-06

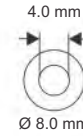

05-0190-08



Poole
22 cm / 8½"
With Tube To Be Screwed Off



Poole
22 cm / 8½"
With Tube To Be Screwed Off



06

Scissors

Scheren

Tijeras

Forbici



Standard
Straight
Blunt / Blunt

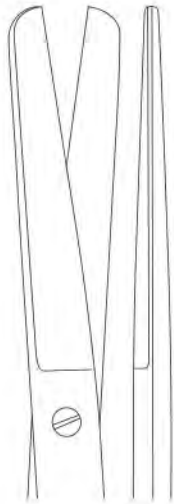

- 06-0010-10 10 cm / 4"
- 06-0010-11 11 cm / 4 1/4"
- 06-0010-13 13 cm / 5"
- 06-0010-14 14 cm / 5 1/2"
- 06-0010-15 15 cm / 6"
- 06-0010-16 16 cm / 6 1/4"
- 06-0010-17 17 cm / 6 3/4"
- 06-0010-18 18 cm / 7"
- 06-0010-20 20 cm / 8"

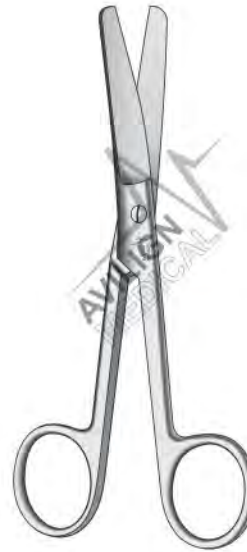

Standard
Curved
Blunt / Blunt

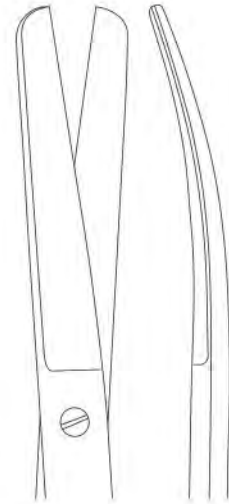

- 06-0020-10 10 cm / 4"
- 06-0020-11 11 cm / 4 1/4"
- 06-0020-13 13 cm / 5"
- 06-0020-14 14 cm / 5 1/2"
- 06-0020-15 15 cm / 6"
- 06-0020-16 16 cm / 6 1/4"
- 06-0020-17 17 cm / 6 3/4"
- 06-0020-18 18 cm / 7"
- 06-0020-20 20 cm / 8"



Standard
Straight
Sharp / Blunt

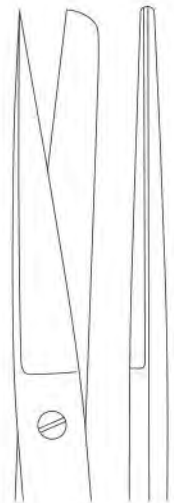

- 06-0030-10 10 cm / 4"
- 06-0030-11 11 cm / 4 1/4"
- 06-0030-13 13 cm / 5"
- 06-0030-14 14 cm / 5 1/2"
- 06-0030-15 15 cm / 6"
- 06-0030-16 16 cm / 6 1/4"
- 06-0030-17 17 cm / 6 3/4"
- 06-0030-18 18 cm / 7"
- 06-0030-20 20 cm / 8"

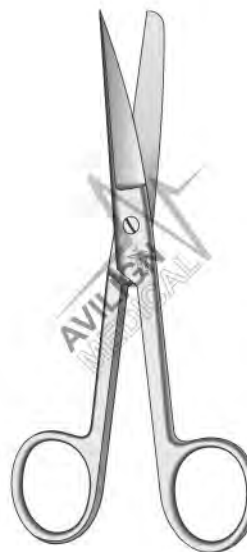

Standard
Curved
Sharp / Blunt

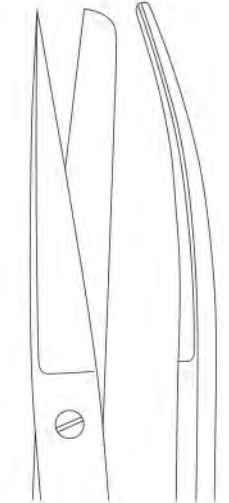

- 06-0040-10 10 cm / 4"
- 06-0040-11 11 cm / 4 1/4"
- 06-0040-13 13 cm / 5"
- 06-0040-14 14 cm / 5 1/2"
- 06-0040-15 15 cm / 6"
- 06-0040-16 16 cm / 6 1/4"
- 06-0040-17 17 cm / 6 3/4"
- 06-0040-18 18 cm / 7"
- 06-0040-20 20 cm / 8"

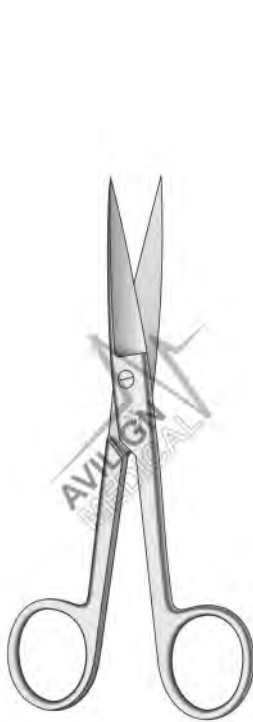

Standard
 Straight
 Sharp / Sharp

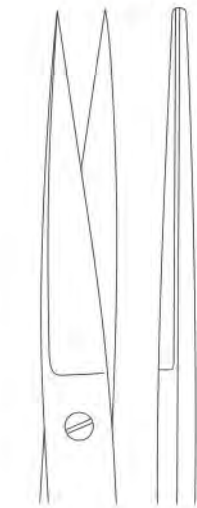

- 06-0050-10 10 cm / 4"
- 06-0050-11 11 cm / 4¼"
- 06-0050-13 13 cm / 5"
- 06-0050-14 14 cm / 5½"
- 06-0050-15 15 cm / 6"
- 06-0050-16 16 cm / 6¼"
- 06-0050-17 17 cm / 6¾"
- 06-0050-18 18 cm / 7"
- 06-0050-20 20 cm / 8"



Standard
 Curved
 Sharp / Sharp

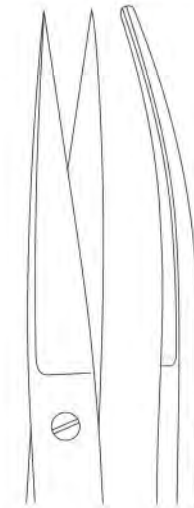

- 06-0060-10 10 cm / 4"
- 06-0060-11 11 cm / 4¼"
- 06-0060-13 13 cm / 5"
- 06-0060-14 14 cm / 5½"
- 06-0060-15 15 cm / 6"
- 06-0060-16 16 cm / 6¼"
- 06-0060-17 17 cm / 6¾"
- 06-0060-18 18 cm / 7"
- 06-0060-20 20 cm / 8"

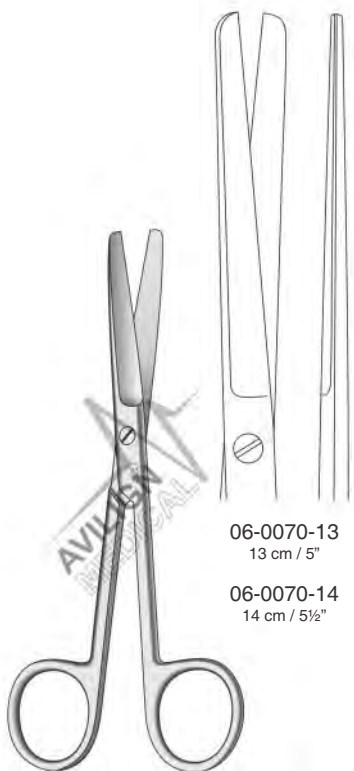

Grazil
 Delicate Pattern
 Straight

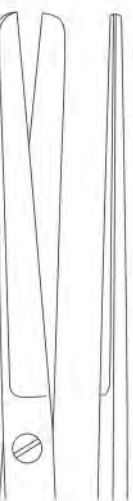

- 06-0070-13
13 cm / 5"
- 06-0070-14
14 cm / 5½"

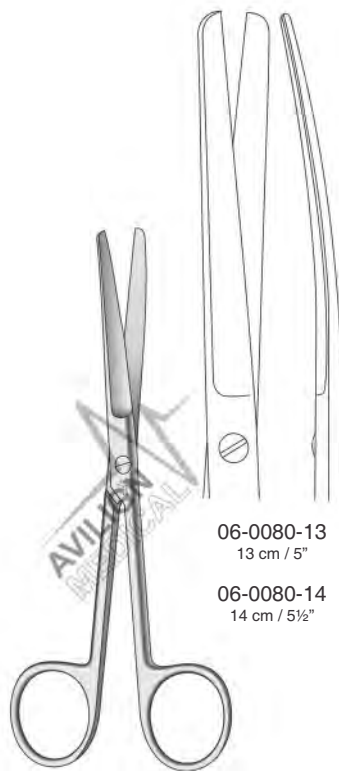

Grazil
 Delicate Pattern
 Curved

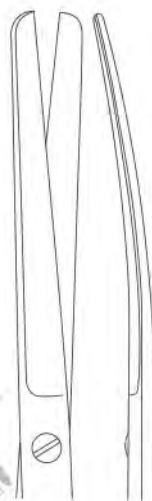

- 06-0080-13
13 cm / 5"
- 06-0080-14
14 cm / 5½"

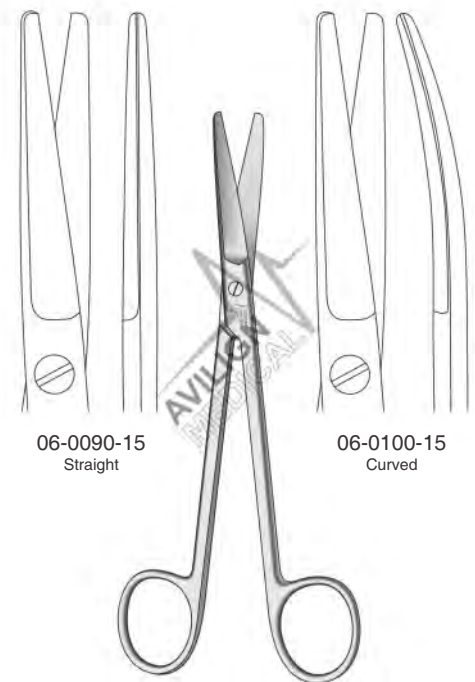

Mixer
 15 cm / 6"

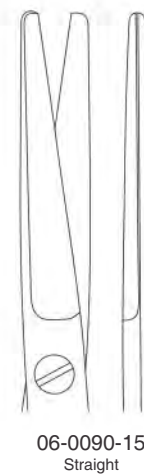

- 06-0090-15
Straight

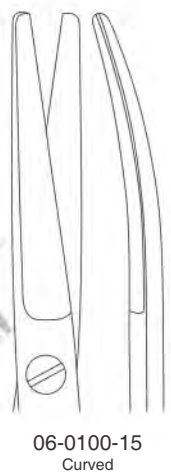

- 06-0100-15
Curved

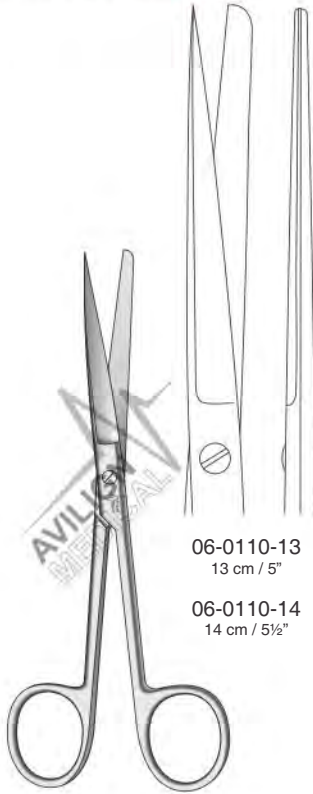

06-0110-13
13 cm / 5"
06-0110-14
14 cm / 5½"

Grazil
Straight
Sharp / Blunt

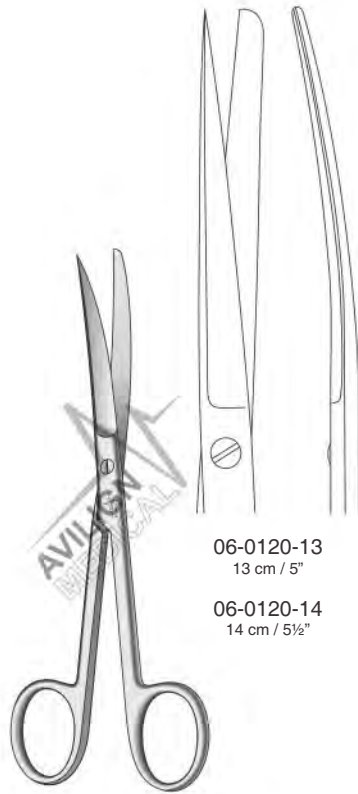

06-0120-13
13 cm / 5"
06-0120-14
14 cm / 5½"

Grazil
Curved
Sharp / Blunt

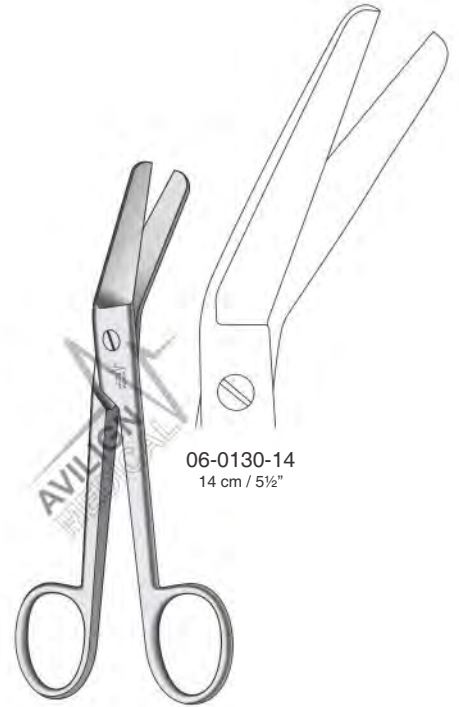

06-0130-14
14 cm / 5½"

Richter

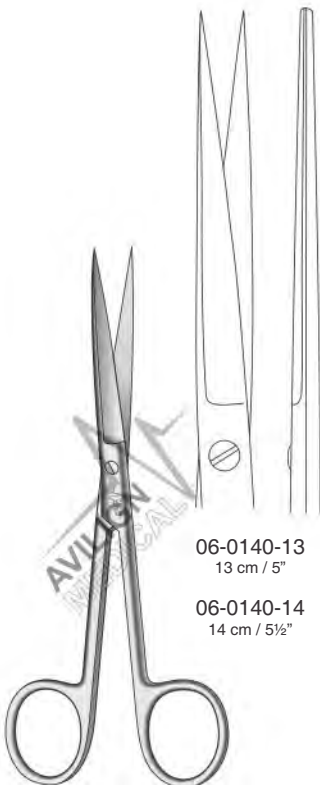

06-0140-13
13 cm / 5"
06-0140-14
14 cm / 5½"

Grazil
Straight
Sharp / Sharp



06-0150-13
13 cm / 5"
06-0150-14
14 cm / 5½"

Grazil
Curved
Sharp / Sharp

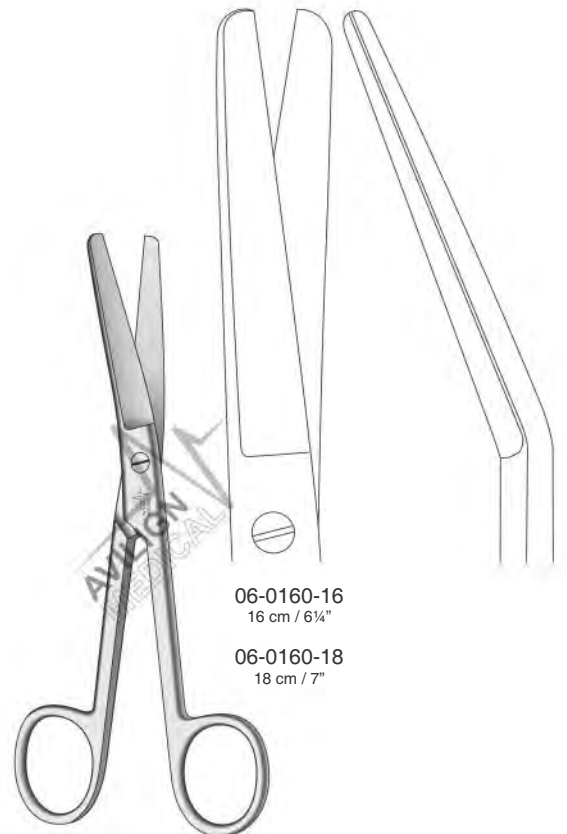

06-0160-16
16 cm / 6¼"
06-0160-18
18 cm / 7"

Fergusson

Uterusscheren, Gynäkologische Scheren
 Tijeras uterinas, Tijeras para ginecología
 Forbici da uteroa, Forbici per ginecologia
 Uterine Scissors, Gynaecological Scissors

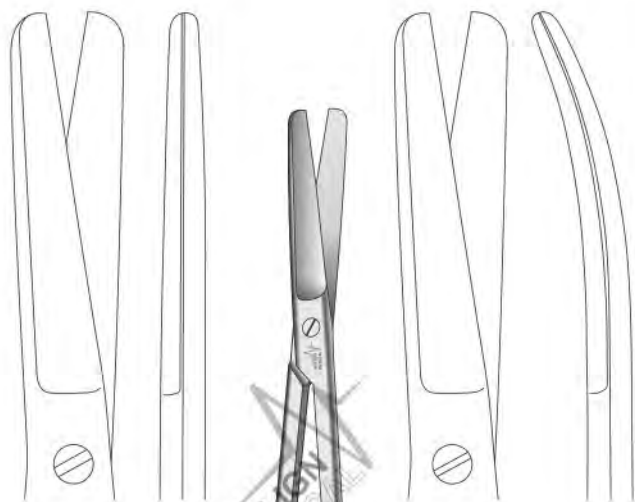

06-0170-20 20 cm / 8"
 06-0170-23 23 cm / 9"
 06-0170-25 25 cm / 9 3/4"
 Straight

06-0180-20 20 cm / 8"
 06-0180-23 23 cm / 9"
 06-0180-25 25 cm / 9 3/4"
 Curved

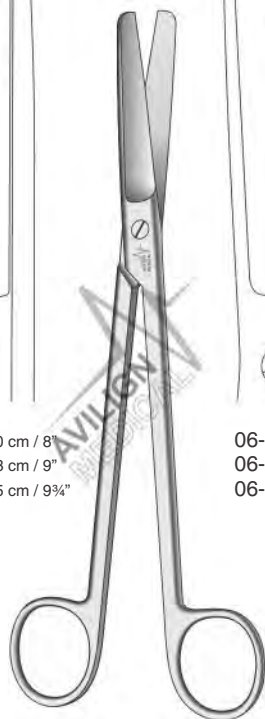

Sims

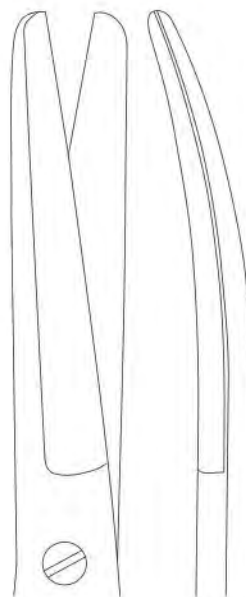

06-0190-24
 24 cm / 9 1/2"
 Curved

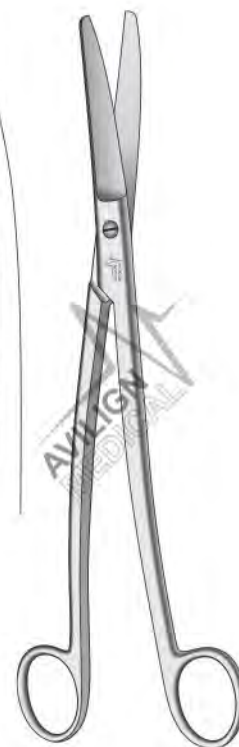

Sims-Siebold
 S-Shaped

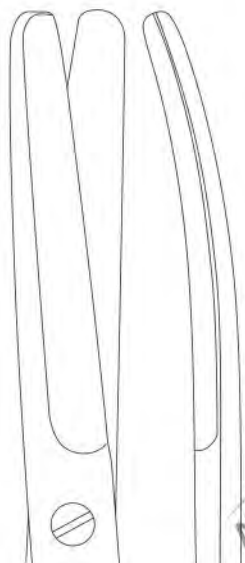

06-0200-30
 30 cm / 11 3/4"
 Curved

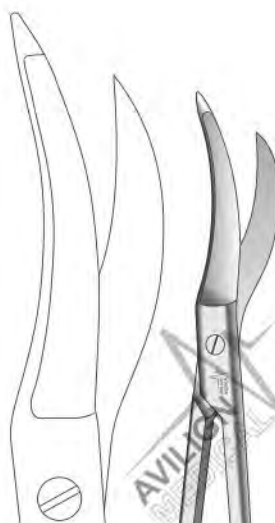

06-0210-18
 18 cm / 7"

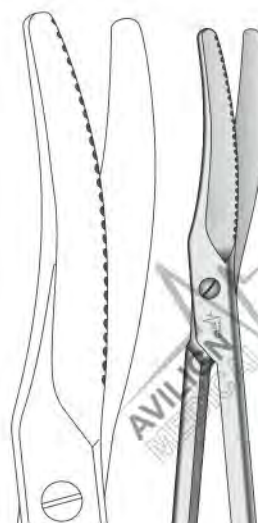

06-0220-20
 20 cm / 8"

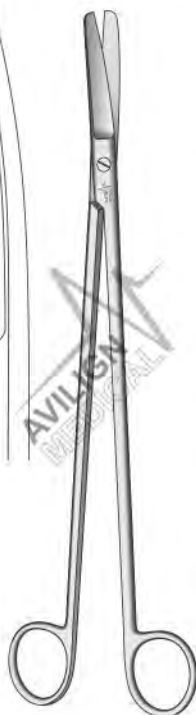

Crafoord

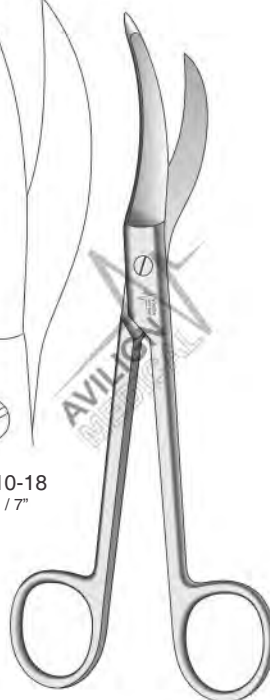

Waldmann
 Perineum Scissors
 (Episiotomy)

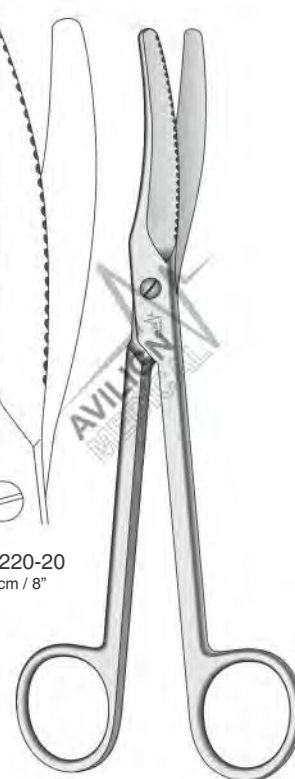

Waldmann
 One Blade Serrated
 Perineum Scissors
 (Episiotomy)

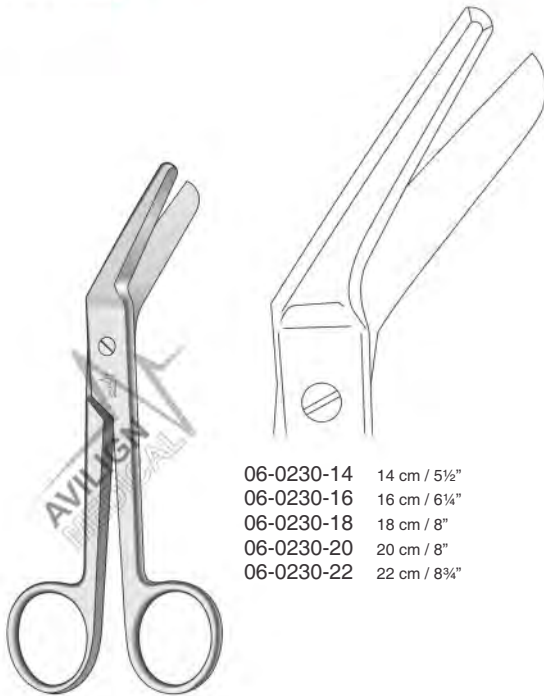

- 06-0230-14 14 cm / 5½"
- 06-0230-16 16 cm / 6¼"
- 06-0230-18 18 cm / 8"
- 06-0230-20 20 cm / 8"
- 06-0230-22 22 cm / 8¾"

Braun-Stadler
Perineum Scissors
(Episiotomy)

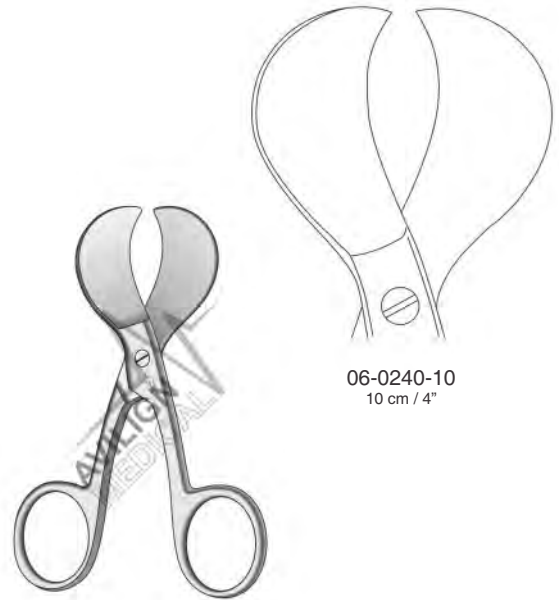

- 06-0240-10
10 cm / 4"

Mod. USA
Umbilical Cord Scissors

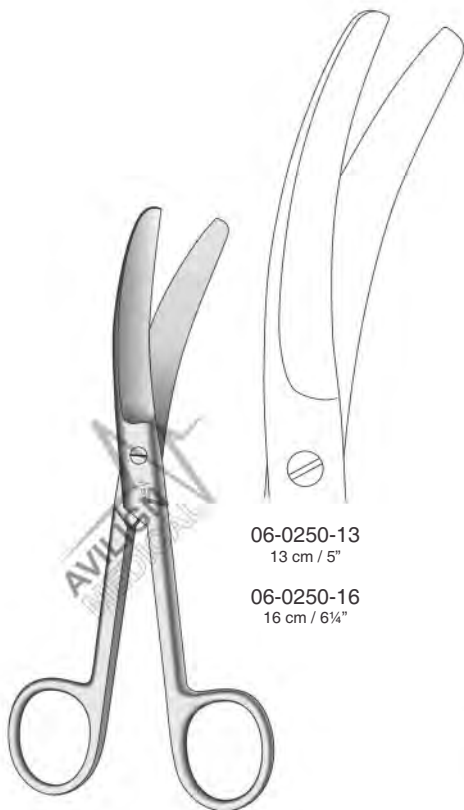

- 06-0250-13
13 cm / 5"
- 06-0250-16
16 cm / 6¼"

Busch
Umbilical Cord Scissors

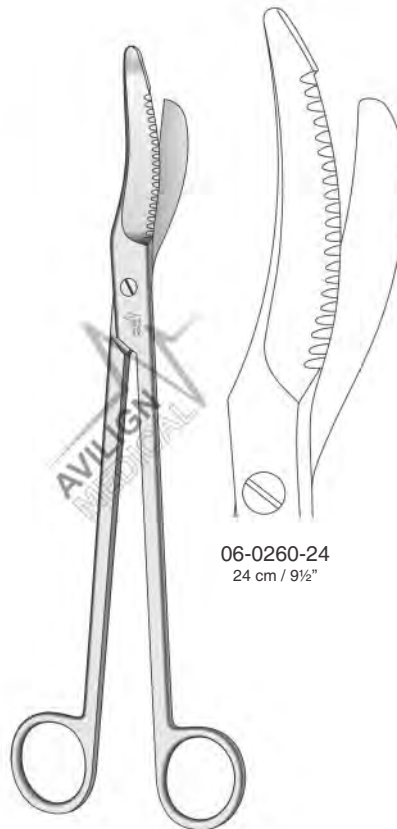

- 06-0260-24
24 cm / 9½"

One Blade Serrated
Perineum Scissors
(Episiotomy)

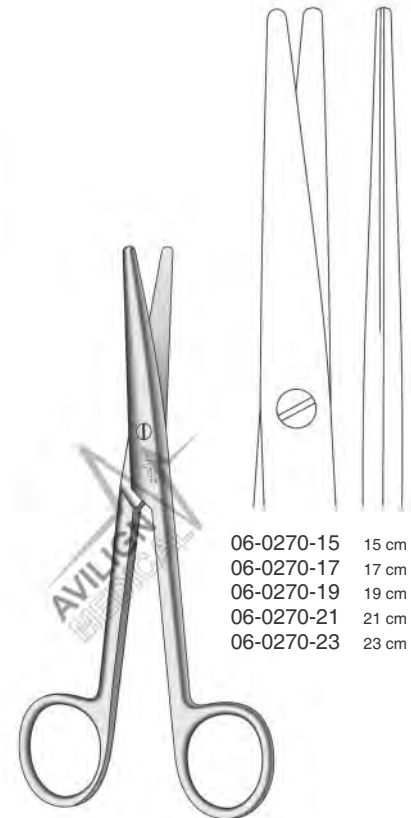

- 06-0270-15 15 cm / 6"
- 06-0270-17 17 cm / 6¾"
- 06-0270-19 19 cm / 7½"
- 06-0270-21 21 cm / 8¼"
- 06-0270-23 23 cm / 9"

Mayo-Stille
Straight

Darmscheren, Chirurgische Scheren
 Tijeras enterótomos, tijeras para cirugía
 Forbici per enterotomia, Forbici per chirurgia
 Enterotomy Scissors, Surgical Scissors

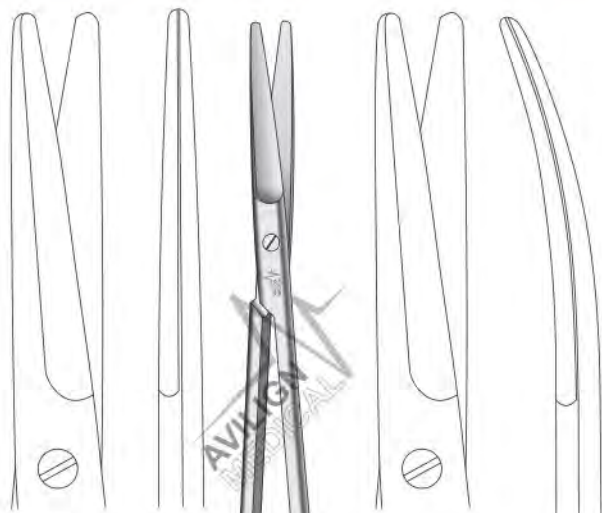

06-0280-22
Straight

06-0290-22
Curved

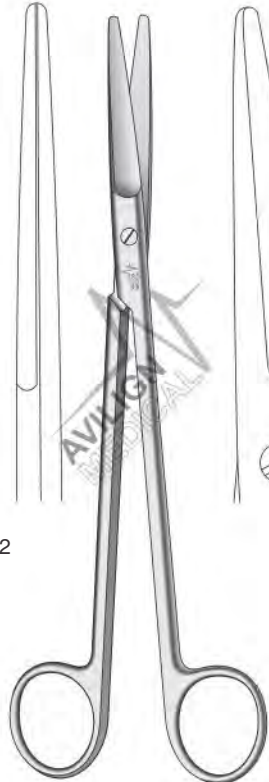

Mayo-Harrington
22 cm / 8¾"



06-0300-21
21 cm / 8¼"

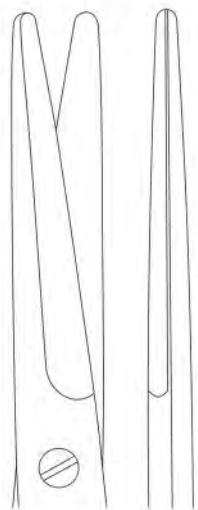

- 06-0310-14 14 cm / 5½"
- 06-0310-15 15 cm / 6"
- 06-0310-17 17 cm / 6¾"
- 06-0310-19 19 cm / 7½"
- 06-0310-23 23 cm / 9"
- 06-0310-30 30 cm / 11¾"

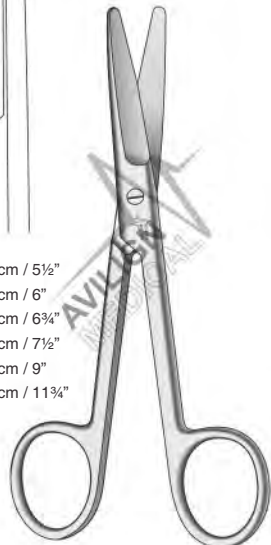

Mayo
Straight

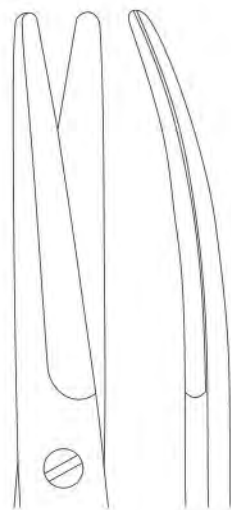

- 06-0320-14 14 cm / 5½"
- 06-0320-15 15 cm / 6"
- 06-0320-17 17 cm / 6¾"
- 06-0320-19 19 cm / 7½"
- 06-0320-23 23 cm / 9"
- 06-0320-30 30 cm / 11¾"

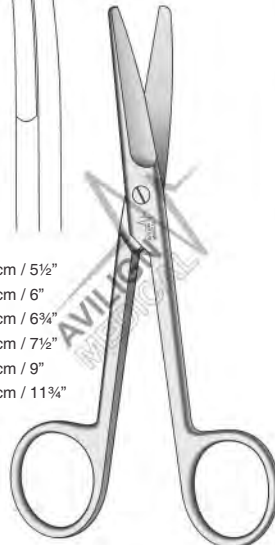

Mayo
Curved



06-0330-17
17 cm / 6¾"
Straight



Mayo-Noble

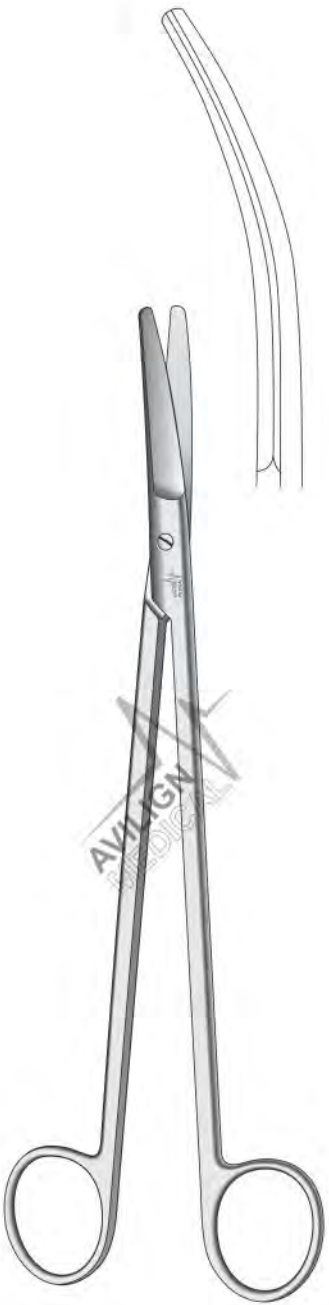

Lloyd-Davies
06-0340-26
26 cm / 10 1/4"
Curved



06-0350-32
32 cm / 12 1/2"
Curved

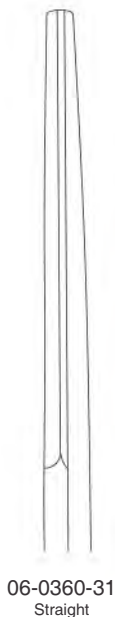

06-0360-31
Straight

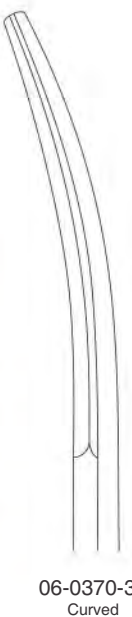

06-0370-31
Curved

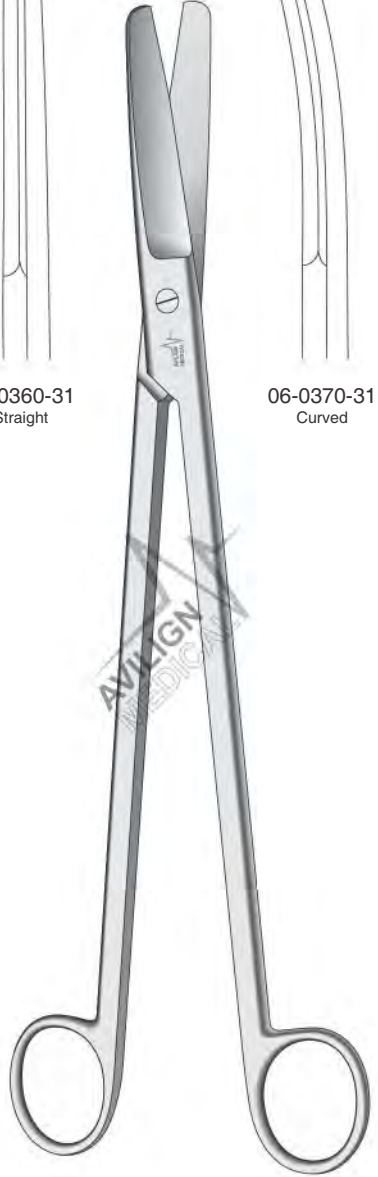

Stelzner
31 cm / 12 1/4"

Präparierscheren
 Tijeras des disección
 Forbici per dissezione
 Dissecting Scissors

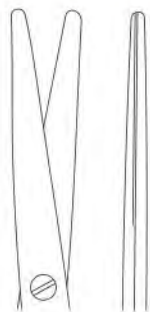

- 06-0380-14 14 cm / 5½"
- 06-0380-18 18 cm / 7"
- 06-0380-20 20 cm / 8"
- 06-0380-23 23 cm / 9"
- 06-0380-25 25 cm / 9¾"
- 06-0380-28 28 cm / 11"
- 06-0380-30 30 cm / 12"
- 06-0380-36 36 cm / 14¼"

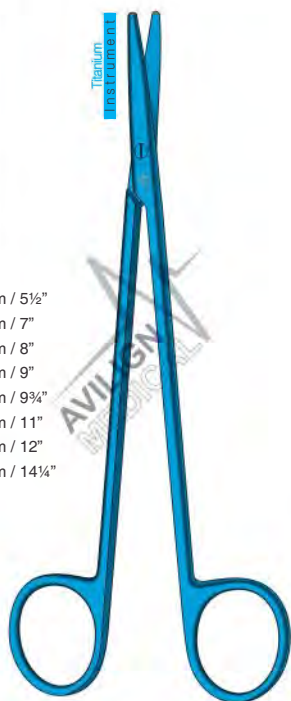

Metzenbaum
 Straight, Blunt

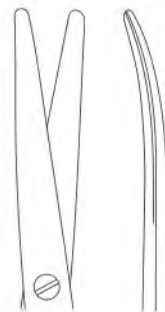

- 06-0390-14 14 cm / 5½"
- 06-0390-18 18 cm / 7"
- 06-0390-20 20 cm / 8"
- 06-0390-23 23 cm / 9"
- 06-0390-25 25 cm / 9¾"
- 06-0390-28 28 cm / 11"
- 06-0390-30 30 cm / 12"
- 06-0390-36 36 cm / 14¼"



Metzenbaum
 Curved, Blunt

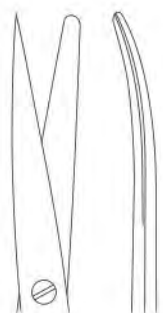

- 06-0400-14 14 cm / 5½"
- 06-0400-18 18 cm / 7"
- 06-0400-20 20 cm / 8"

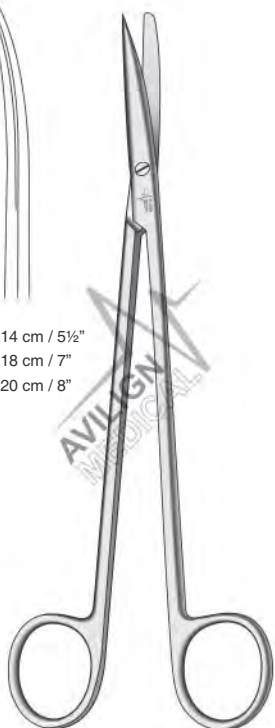

Metzenbaum

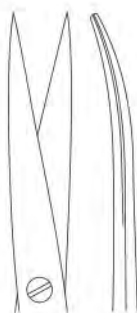

- 06-0410-14
 14 cm / 5½"



Metzenbaum

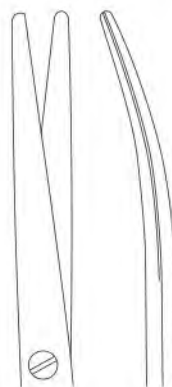

- 06-0420-14 14 cm / 5½"
- 06-0420-18 18 cm / 7"
- 06-0420-20 20 cm / 8"
- 06-0420-23 23 cm / 9"
- 06-0420-25 25 cm / 9¾"

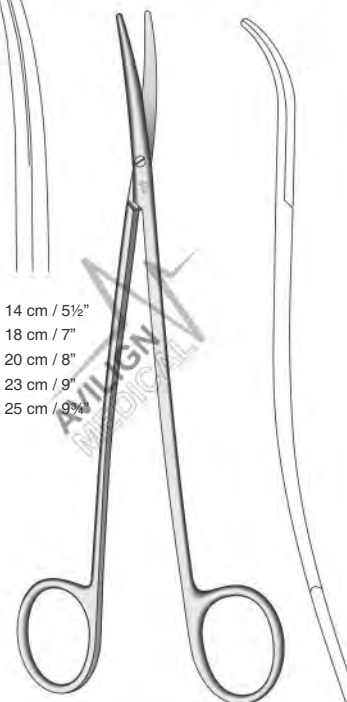

Metzenbaum-Fino
 Straight
 Blunt / Blunt

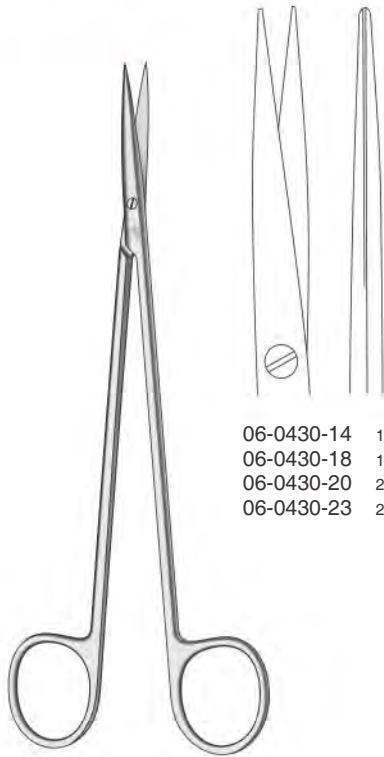

- 06-0430-14 14 cm / 5½"
- 06-0430-18 18 cm / 7"
- 06-0430-20 20 cm / 8"
- 06-0430-23 23 cm / 9"

Metzenbaum-Fino
Straight
Sharp / Sharp

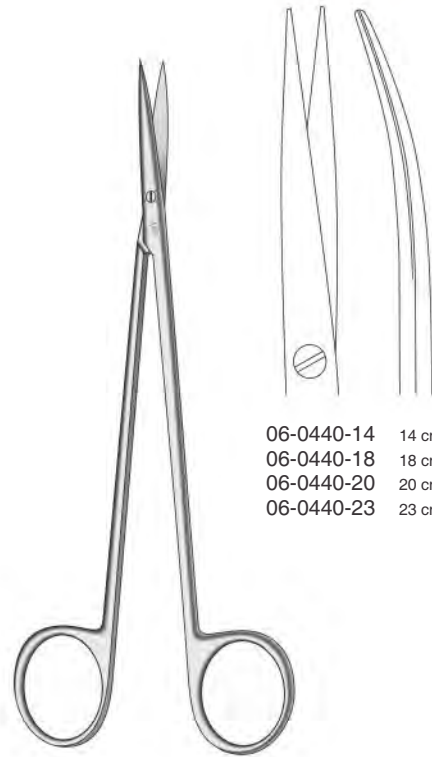

- 06-0440-14 14 cm / 5½"
- 06-0440-18 18 cm / 7"
- 06-0440-20 20 cm / 8"
- 06-0440-23 23 cm / 9"

Metzenbaum-Fino
Curved
Sharp / Sharp

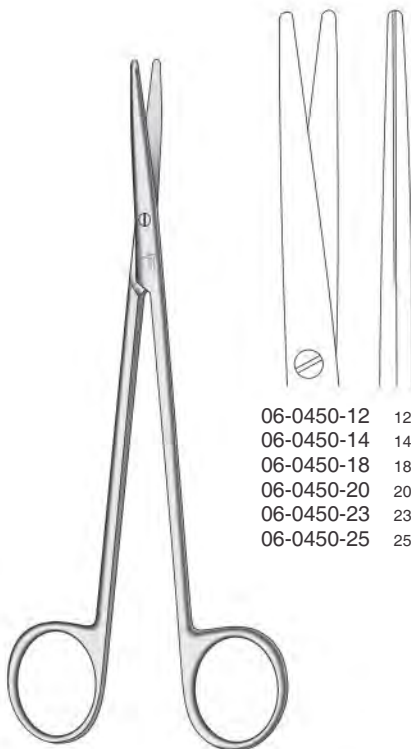

- 06-0450-12 12 cm / 4¾"
- 06-0450-14 14 cm / 5½"
- 06-0450-18 18 cm / 7"
- 06-0450-20 20 cm / 8"
- 06-0450-23 23 cm / 9"
- 06-0450-25 25 cm / 9¾"

Metzenbaum-Fino
Straight
Blunt / Blunt

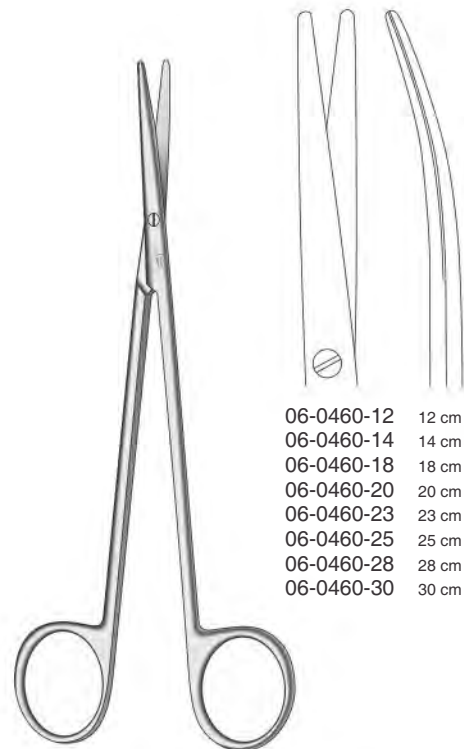

- 06-0460-12 12 cm / 4¾"
- 06-0460-14 14 cm / 5½"
- 06-0460-18 18 cm / 7"
- 06-0460-20 20 cm / 8"
- 06-0460-23 23 cm / 9"
- 06-0460-25 25 cm / 9¾"
- 06-0460-28 28 cm / 11"
- 06-0460-30 30 cm / 12"

Metzenbaum-Fino
S-Shape

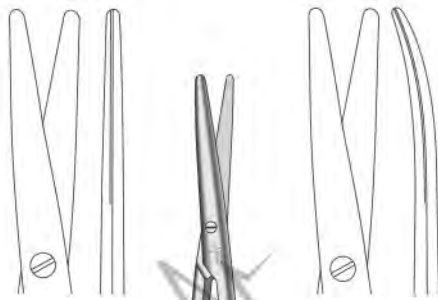

06-0470-15
 Straight

06-0480-15
 Curved



Metzenbaum
 15 cm / 6"
 Short Blades

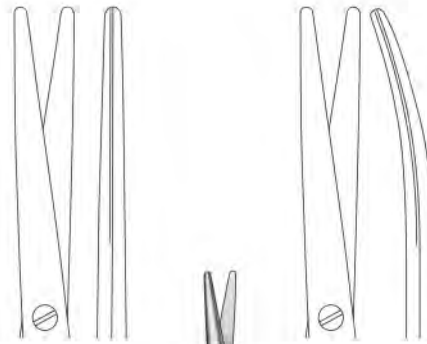

06-0490-11
 Straight

06-0500-11
 Curved

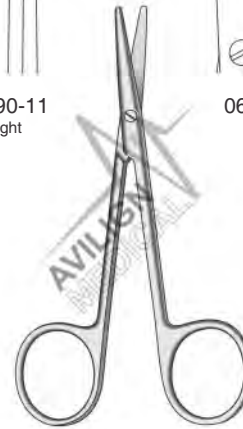

Metzenbaum-Baby
 11 cm / 4¼"

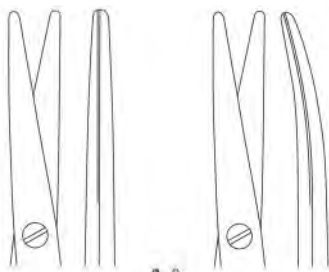

06-0510-10
 Straight

06-0520-10
 Curved



Lexer-Baby
 10 cm / 4"

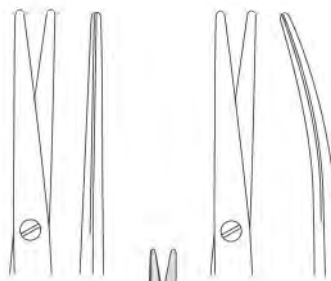

06-0530-09
 9 cm / 3½"

06-0540-09
 9 cm / 3½"

06-0530-11
 11 cm / 4¼"
 Straight

06-0540-11
 11 cm / 4¼"
 Curved

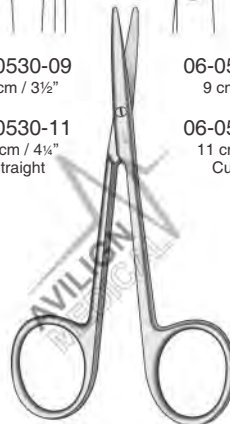

Strabismus

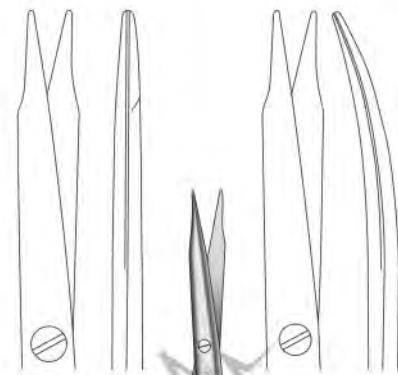

06-0550-13
 13 cm / 5"

06-0560-13
 13 cm / 5"

06-0550-15
 15 cm / 6"

06-0560-15
 15 cm / 6"

06-0550-18
 18 cm / 7"
 Straight

06-0560-18
 18 cm / 7"
 Curved

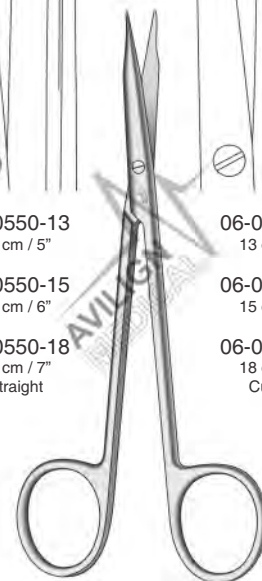

Reynolds

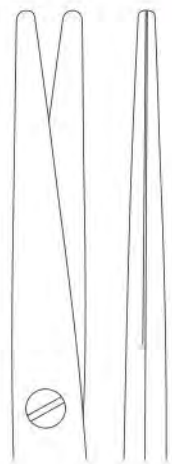

06-0570-16
Straight

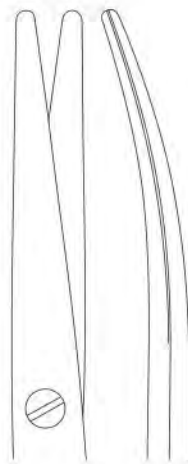

06-0580-16
Curved

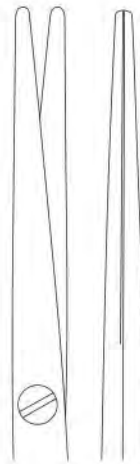

06-0590-16
Straight

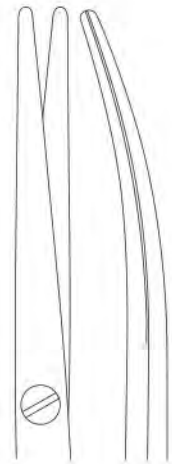

06-0600-16
Curved



Lexer
16 cm / 6¼"



Lexer-Fino
16 cm / 6¼"

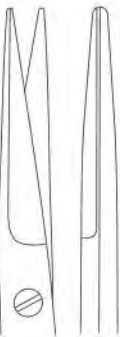

06-0610-18
18 cm / 7"



06-0620-17
17.5 cm / 7"

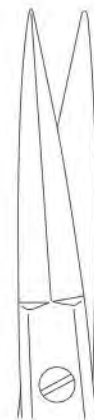

06-0630-19
Straight

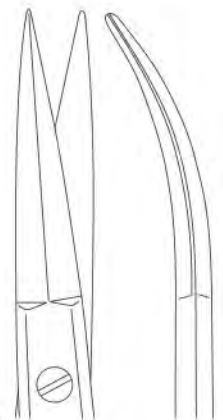

06-0640-19
Curved

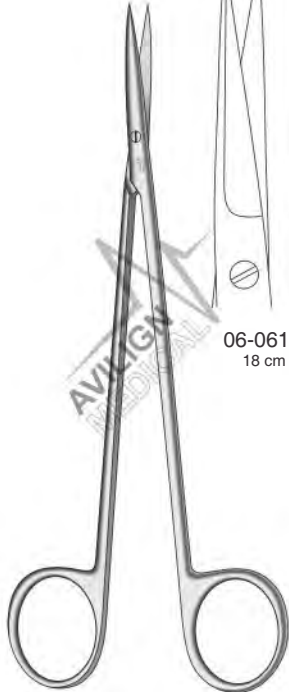

Toennis-Fino

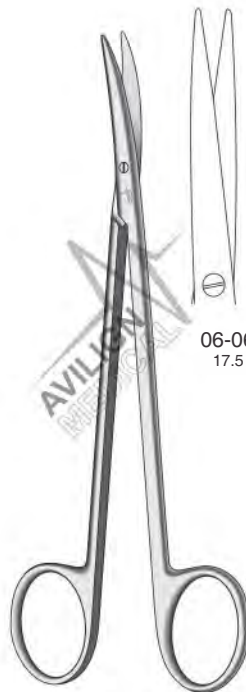

De Bakey
Dissecting Scissors

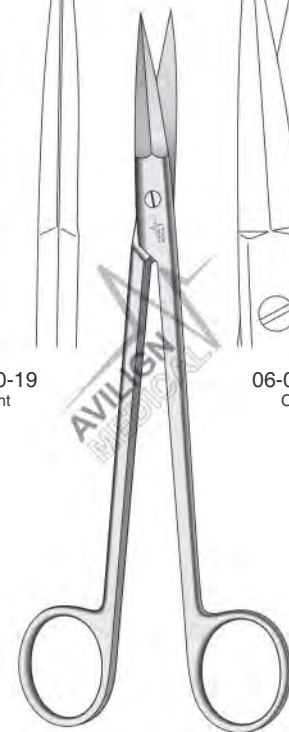

Mc Indoe
19 cm / 7½"
Cartilage Scissors

Tonsillenscheren, Knorpelscheren, Gefabscheren
 Tijeras para amígdalas, Tijeras para cartilago, Tijeras vasculares
 Forbici per tonsille, Forbici per cartilagini, Forbici vascolari
 Tonsil Scissors, Cartilage Scissors, Vascular Scissors

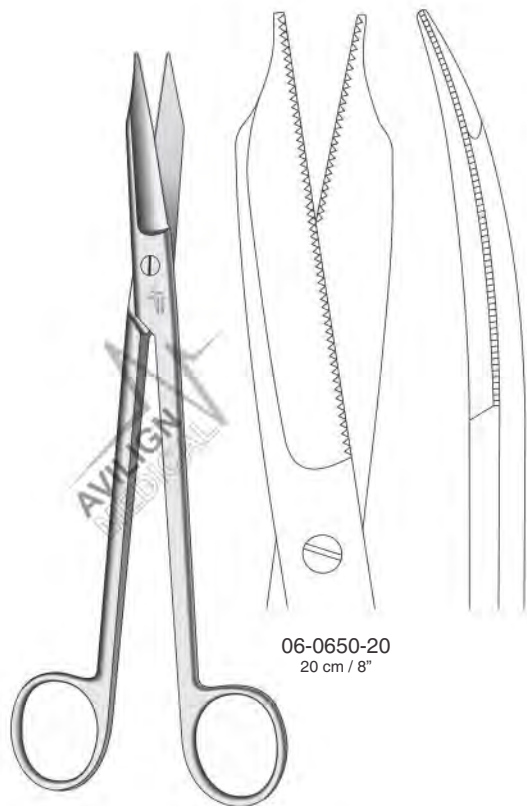

06-0650-20
20 cm / 8"

Cartilage Scissors
One Blade Serrated

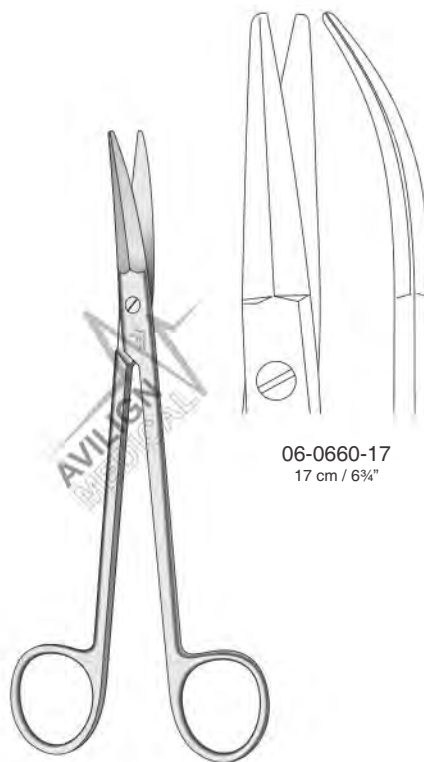

06-0660-17
17 cm / 6 3/4"

Prince
Tonsil Scissors

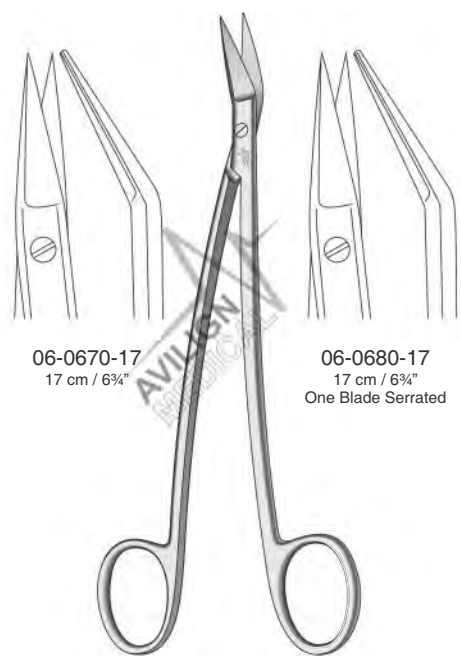

06-0670-17
17 cm / 6 3/4"

06-0680-17
17 cm / 6 3/4"
One Blade Serrated

Dean
Tonsil Scissors

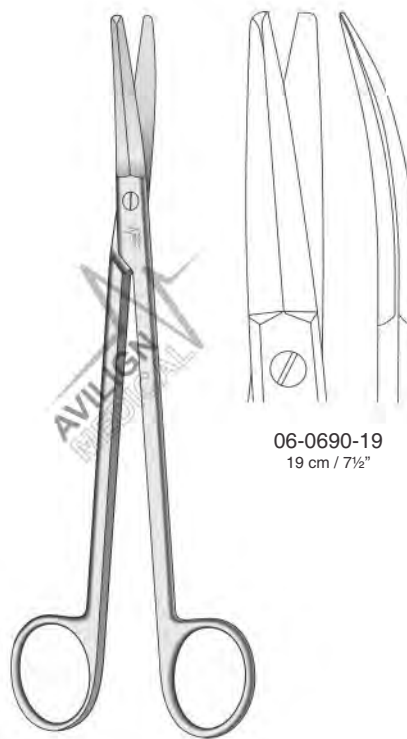

06-0690-19
19 cm / 7 1/2"

Potts-Smith
Vascular Scissors

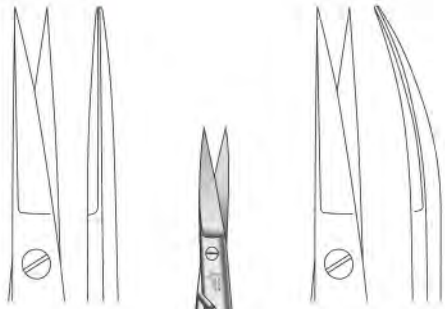

06-0700-16
16 cm / 6¼"

06-0700-18
18 cm / 7"
Straight

06-0710-16
16 cm / 6¼"

06-0710-18
18 cm / 7"
Curved

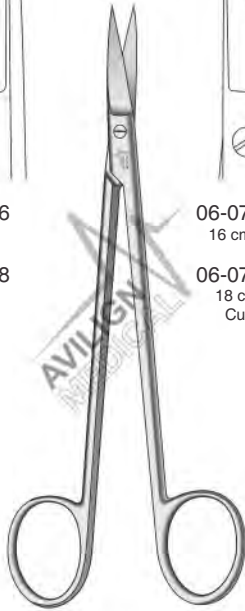

Kelly

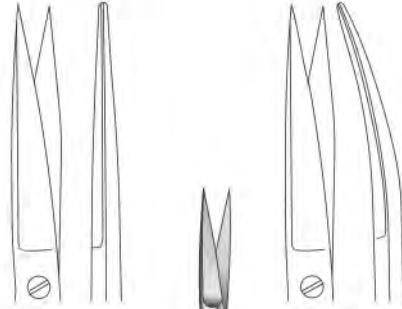

06-0720-14
14 cm / 5½"

06-0720-17
17 cm / 6¾"
Straight

06-0730-14
14 cm / 5½"

06-0730-17
17 cm / 6¾"
Curved



Joseph

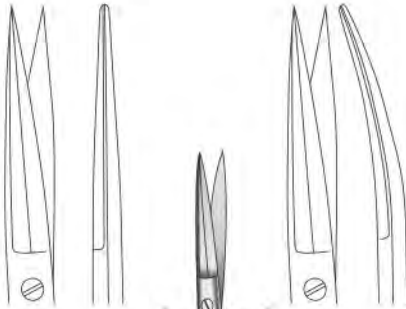

06-0740-15
Straight

06-0750-15
Curved



Peck-Joseph
14.5 cm / 5¾"

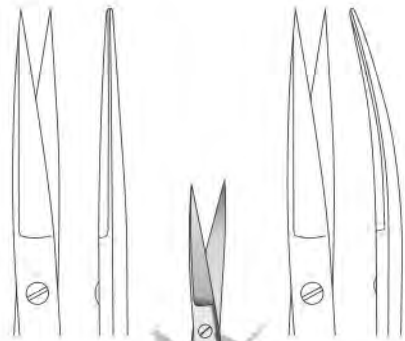

06-0760-14
Straight

06-0770-14
Curved

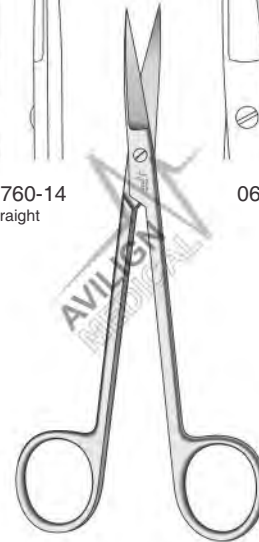

Sanvenero
14 cm / 5½"

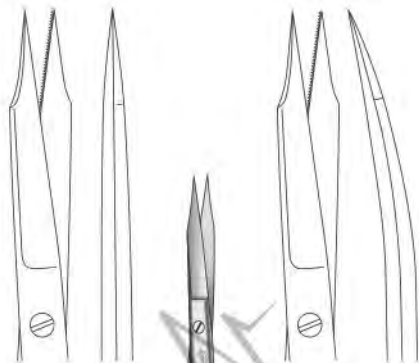

Goldman-Fox
 13 cm / 5"
 One Blade Serrated
 Gum Scissors

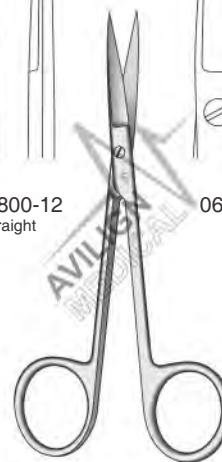
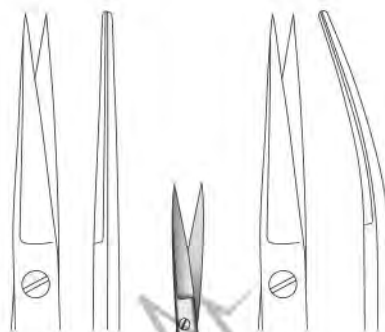

06-0800-12
 Straight

06-0810-12
 Curved

Wagner
 12 cm / 4¾"
 Flat Screw Lock

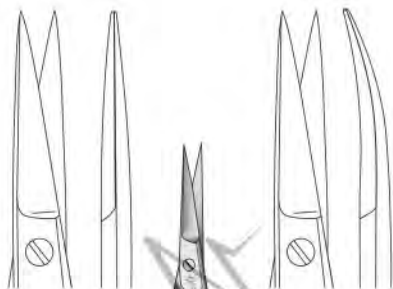

06-0820-11
 Straight

06-0830-11
 Curved



11 cm / 4¼"

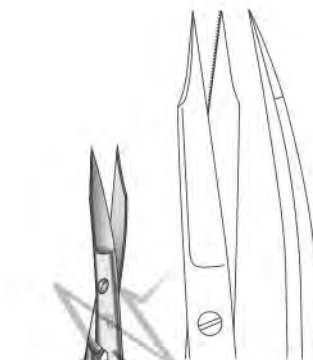

06-0840-12
 13 cm / 5"

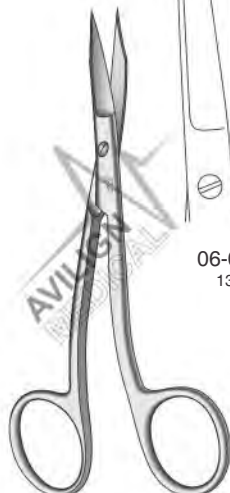

Goldman-Fox
 S-Slaped
 One Blade Serrated
 Gum Scissors



06-0850-11
 11 cm / 4¼"



La Grange
 Gum Scissors

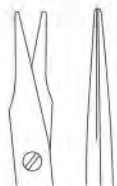

06-0860-10
10 cm / 4"

06-0860-11
11 cm / 4 1/4"
Blunt / Blunt,
Straight

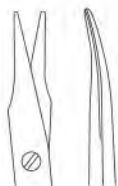

06-0870-10
10 cm / 4"

06-0870-11
11 cm / 4 1/4"
Blunt / Blunt,
Curved

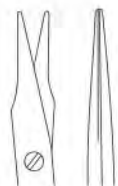

06-0900-10
Blunt / Blunt,
Straight



06-0910-10
Blunt / Blunt,
Curved

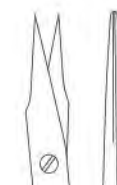

06-0880-10
10 cm / 4"

06-0880-11
11 cm / 4 1/4"
Sharp / Sharp,
Straight



06-0890-10
10 cm / 4"

06-0890-11
11 cm / 4 1/4"
Sharp / Sharp,
Curved

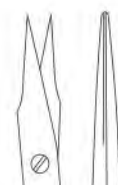

06-0920-10
Sharp / Sharp,
Straight



06-0930-10
Sharp / Sharp,
Curved

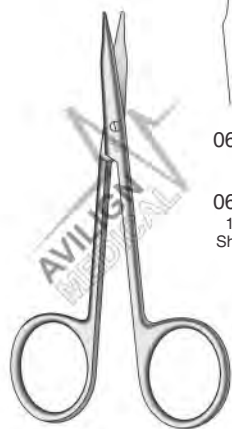

Stevens



Ribbon-Stevens
9.5 cm / 3 3/4"

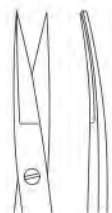

06-0940-09
9.5 cm / 3 3/4"

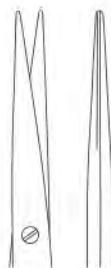

06-0950-11
Straight



06-0960-11
Curved



06-0970-08
8 cm / 3"

06-0970-09
9 cm / 3 1/2"
Straight



06-0980-08
8 cm / 3"

06-0980-09
9 cm / 3 1/2"
Curved



Salyer
Face-Lift Scissors

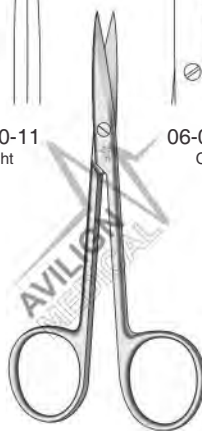

Kilner
11 cm / 4 1/4"

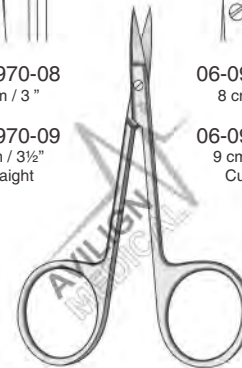

Bonn

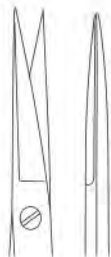

- 06-0990-09 9 cm / 3½"
- 06-0990-10 10 cm / 4"
- 06-0990-11 11 cm / 4¼"
- 06-0990-12 12 cm / 4¾"

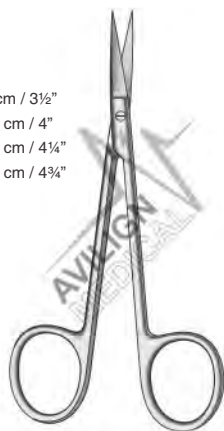

Iris Standard
 Straight

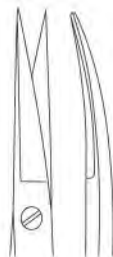

- 06-1000-09 9 cm / 3½"
- 06-1000-10 10 cm / 4"
- 06-1000-11 11 cm / 4¼"
- 06-1000-12 12 cm / 4¾"

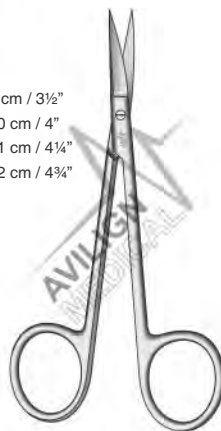

Iris Standard
 Curved

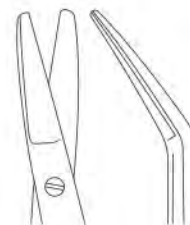

Graefe
 06-1010-10
 9.5 cm / 3¾"

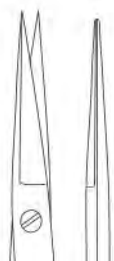

- 06-1020-10 10 cm / 4"
- 06-1020-11 11 cm / 4¼"
 Straight

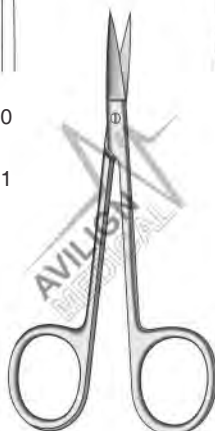

Iris-Fino

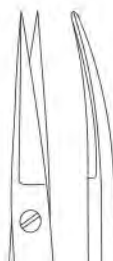

- 06-1030-10 10 cm / 4"
- 06-1030-11 11 cm / 4¼"
 Curved



06-1040-11



06-1050-11



Iris
 11 cm / 4¼"

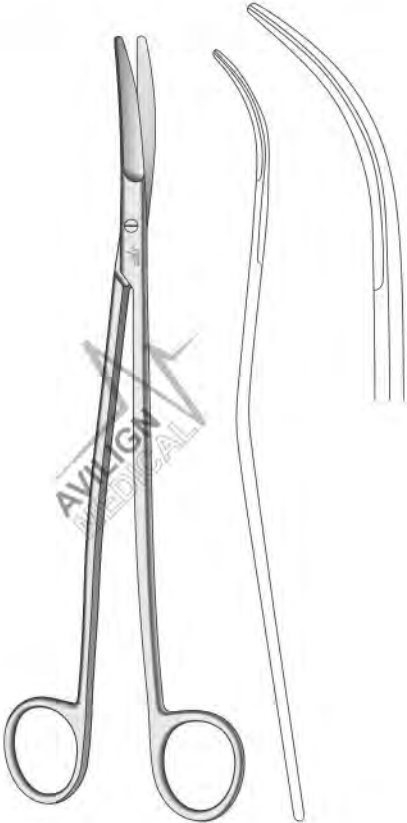

Satinsky
06-1060-24
24 cm / 9½"

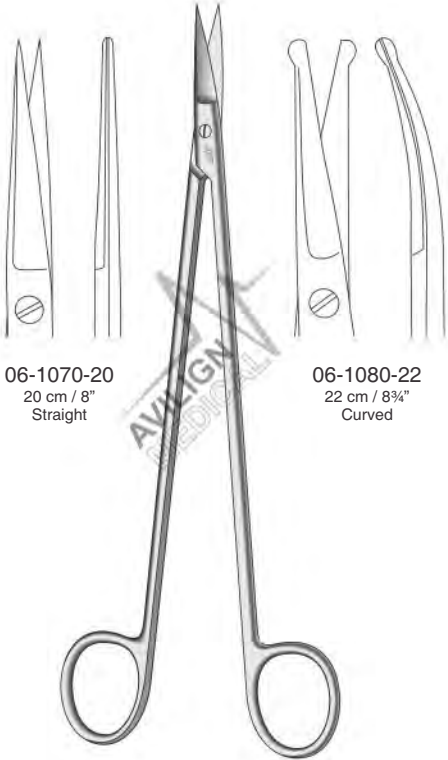

06-1070-20
20 cm / 8"
Straight

06-1080-22
22 cm / 8¾"
Curved

Strully

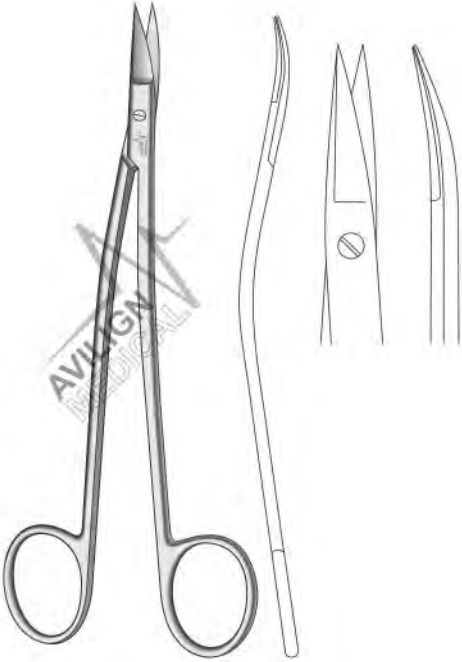

Dandy
06-1090-17
17 cm / 6¾"

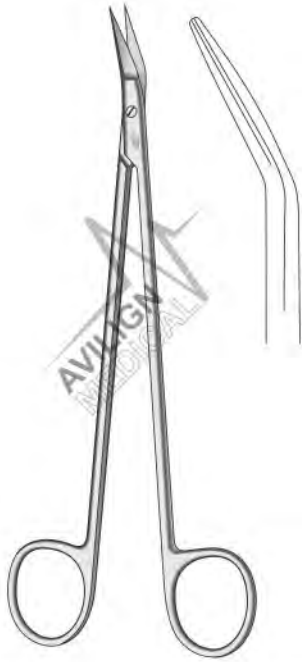

Classon
06-1100-17
17 cm / 6¾"



06-1110-19
 Angled at 25°

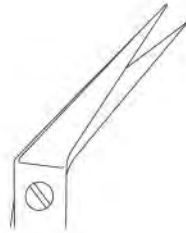

06-1120-19
 Angled at 45°

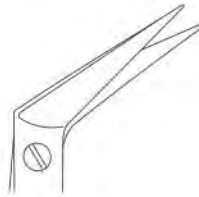

06-1130-19
 Angled at 60°



06-1140-19
 Angled at 25°
 With Probe

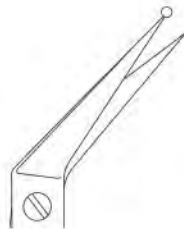

06-1150-19
 Angled at 45°
 With Probe



06-1160-19
 Angled at 60°
 With Probe



Potts-Smith
 19 cm / 7½"



Angled at 25°

06-1170-16
 16 cm / 6¼"

06-1170-19
 19 cm / 7½"

06-1170-23
 23 cm / 9"



Angled at 45°

06-1180-16
 16 cm / 6¼"

06-1180-19
 19 cm / 7½"

06-1180-23
 23 cm / 9"

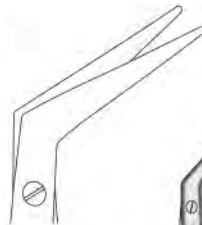

Angled at 60°

06-1190-16
 16 cm / 6¼"

06-1190-19
 19 cm / 7½"

06-1190-23
 23 cm / 9"

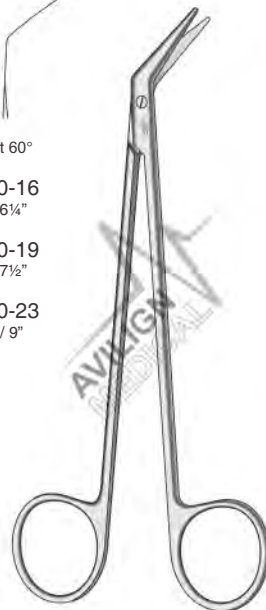

De Bakey

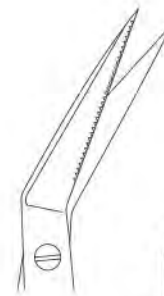

06-1200-16
 16 cm / 6¼"

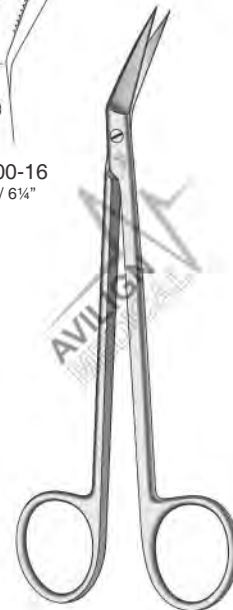

Locklin
 One Blade Serrated

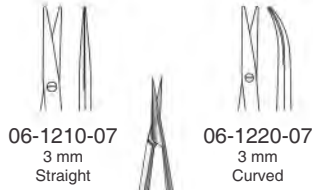

Mini-Vannas
7.5 cm / 3"

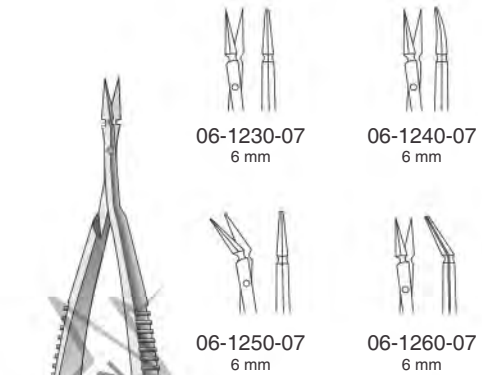

Mini-Vannas
7.5 cm / 3"

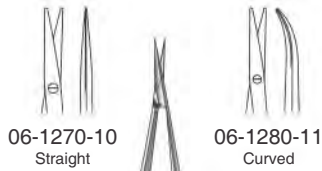

10.5 cm / 4 1/4"



Castroviejo

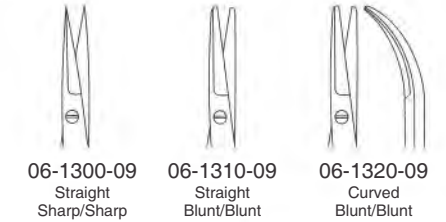

Castroviejo
9 cm / 3 1/2"

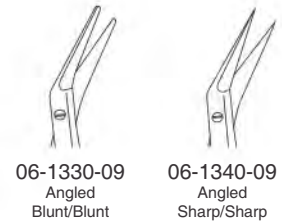



Noyes
 12.5 cm / 5"
 Straight



06-1350-13
 Sharp / Blunt



06-1360-13
 Sharp / Sharp



06-1370-13
 Blunt / Blunt



06-1380-11
 Straight

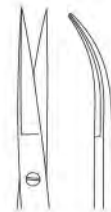

06-1390-11
 Curved

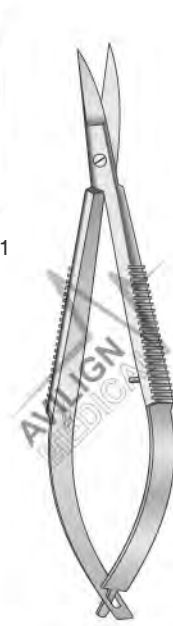

Westcott
 11 cm / 4 1/4"

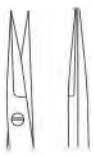

06-1400-15
 15 cm / 6"

06-1400-18
 18 cm / 7"
 Ø 8 mm
 Straight

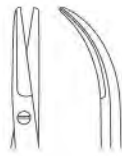

06-1410-15
 15 cm / 6"

06-1410-18
 18 cm / 7"
 Ø 8 mm
 Curved

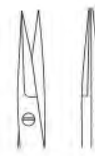

06-1420-14
 Ø 8 mm
 Straight

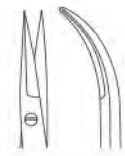

06-1430-14
 Ø 8 mm
 Curved



14 cm / 5 1/2"



Spencer-Fino
06-1440-11
11 cm / 4 1/4"



Spencer
06-1450-09 9 cm / 3 1/2"
06-1450-11 11 cm / 4 1/4"
06-1450-13 12.5 cm / 5"

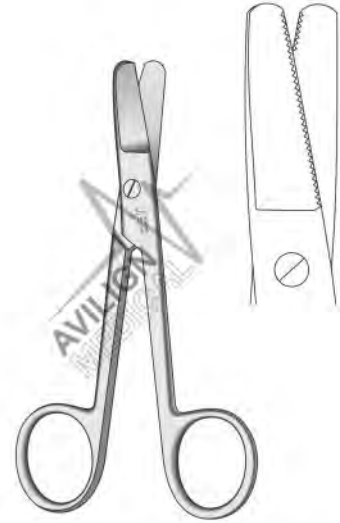

Harvey
06-1460-12
12 cm / 4 3/4"
Both Blades Serrated

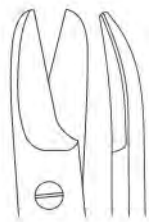

06-1470-10
10 cm / 4"
Curved



06-1480-10
10 cm / 4"
Straight

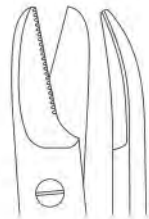

06-1490-12
12 cm / 4 3/4"
One Blade Serrated
Curved

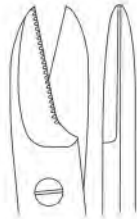

06-1500-12
12 cm / 4 3/4"
One Blade Serrated
Straight

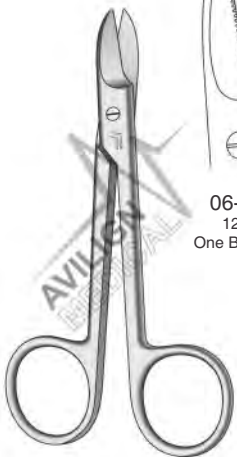

Beebee



Heath
06-1510-15
15 cm / 6"



Universal
06-1520-12
12 cm / 4 3/4"
One Blade Serrated



07

TC Scissors

Scheren mit Hartmetallschnelden
Tijeras con filos de carburo tungsteno
Forbici con lame in carburo I tungsteno

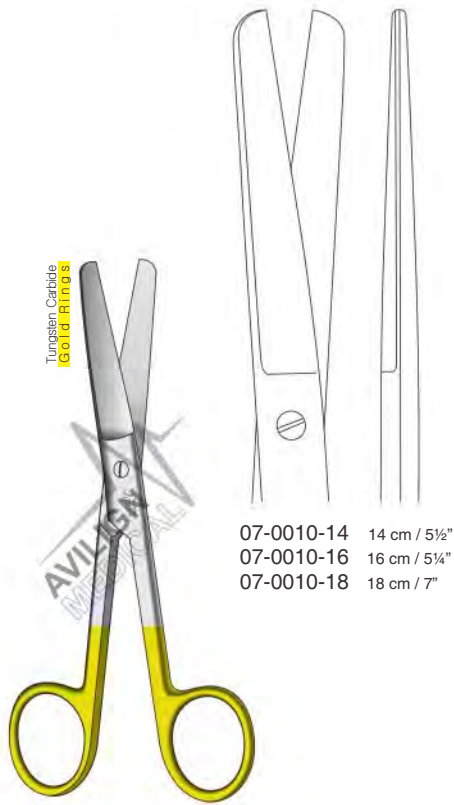

07-0010-14 14 cm / 5½"
07-0010-16 16 cm / 5¼"
07-0010-18 18 cm / 7"

Standard
Straight
Blunt/Blunt

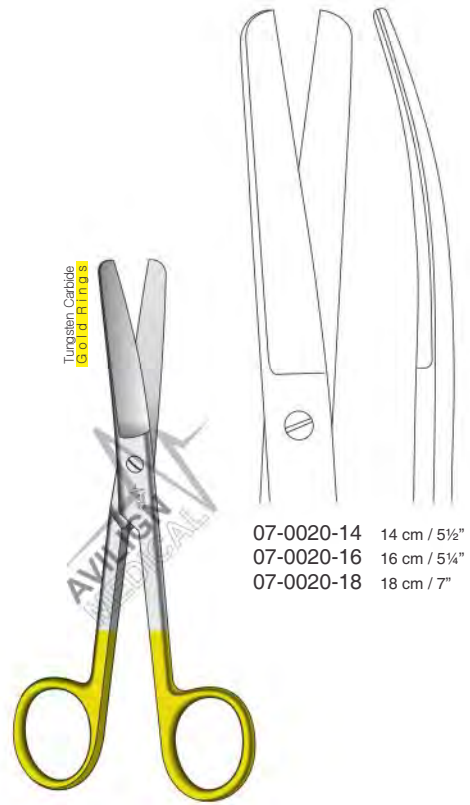

07-0020-14 14 cm / 5½"
07-0020-16 16 cm / 5¼"
07-0020-18 18 cm / 7"

Standard
Curved
Blunt/Blunt

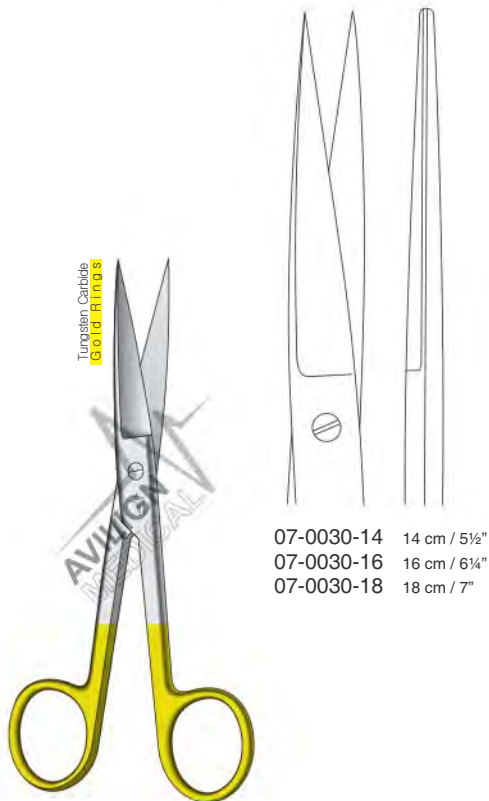

07-0030-14 14 cm / 5½"
07-0030-16 16 cm / 6¼"
07-0030-18 18 cm / 7"

Standard
Straight
Sharp/Sharp

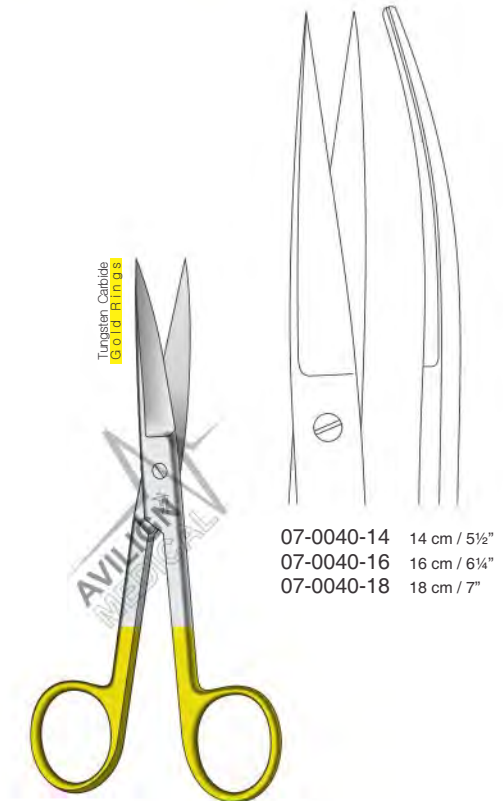

07-0040-14 14 cm / 5½"
07-0040-16 16 cm / 6¼"
07-0040-18 18 cm / 7"

Standard
Curved
Sharp/Sharp

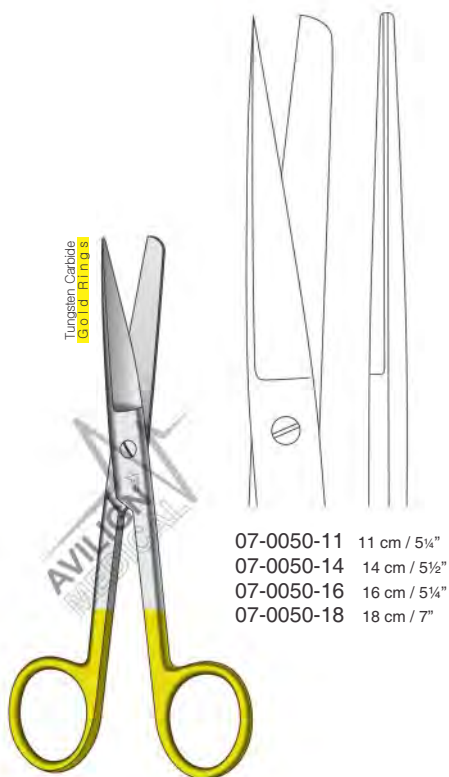

Tungsten Carbide
Gold Rings

- 07-0050-11 11 cm / 5¼"
- 07-0050-14 14 cm / 5½"
- 07-0050-16 16 cm / 5¾"
- 07-0050-18 18 cm / 7"

Standard
 Straight
 Sharp/Blunt

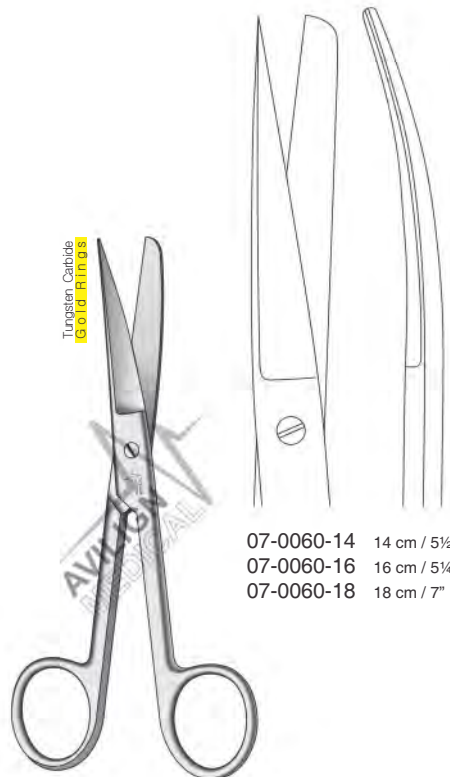

Tungsten Carbide
Gold Rings

- 07-0060-14 14 cm / 5½"
- 07-0060-16 16 cm / 5¾"
- 07-0060-18 18 cm / 7"

Standard
 Curved
 Sharp/Blunt

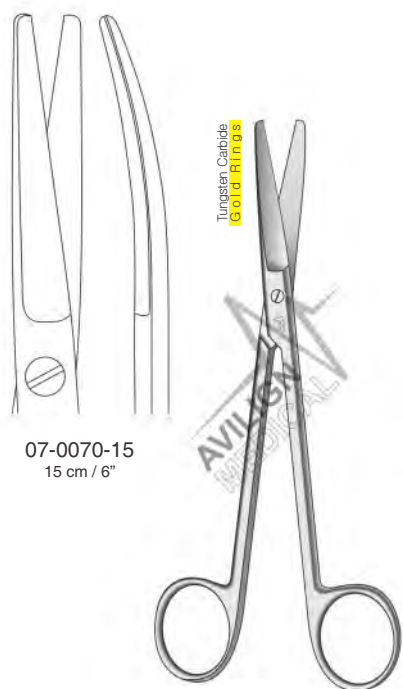

Tungsten Carbide
Gold Rings

- 07-0070-15
 15 cm / 6"

Mixer
 Straight
 Blunt/Blunt

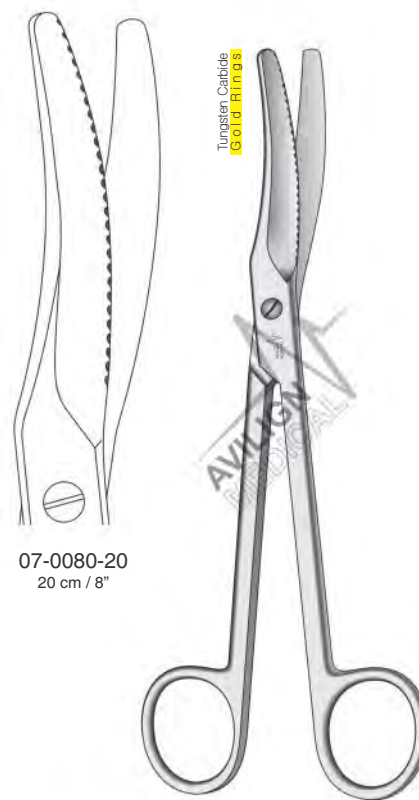

Tungsten Carbide
Gold Rings

- 07-0080-20
 20 cm / 8"

Waldmann
 Perineum Scissors (Episiotomie)
 One Blade Serrated

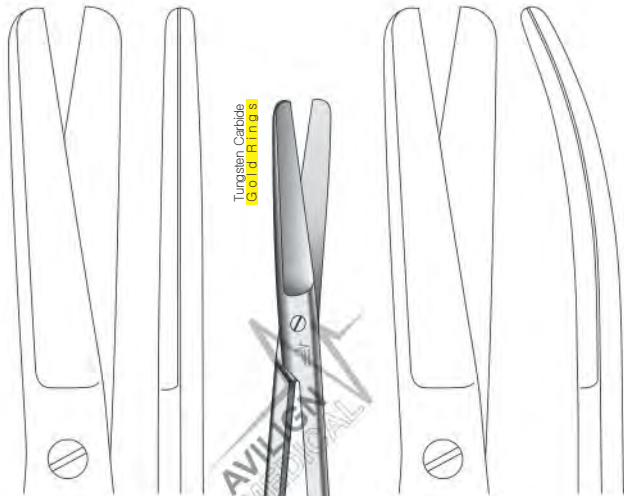

07-0090-20
20 cm / 8"
07-0090-23
23 cm / 9"
Straight

07-0100-20
20 cm / 8"
07-0100-23
23 cm / 9"
Curved

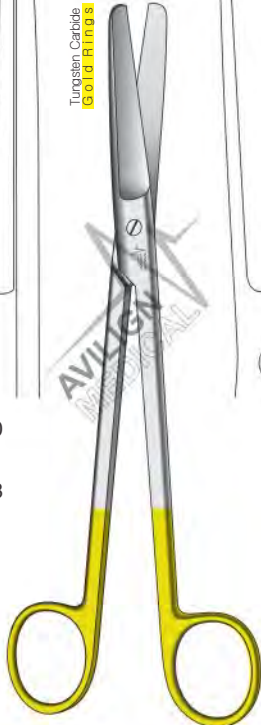

Sims
Blunt/Blunt

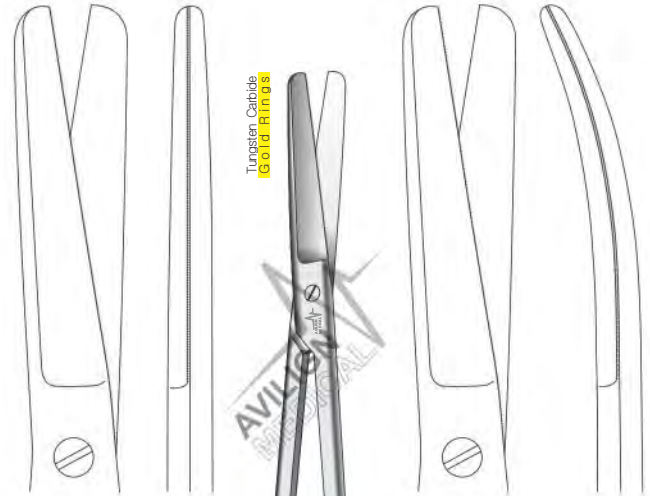

07-0110-20
20 cm / 8"
07-0110-23
23 cm / 9"
Straight

07-0120-20
20 cm / 8"
Curved

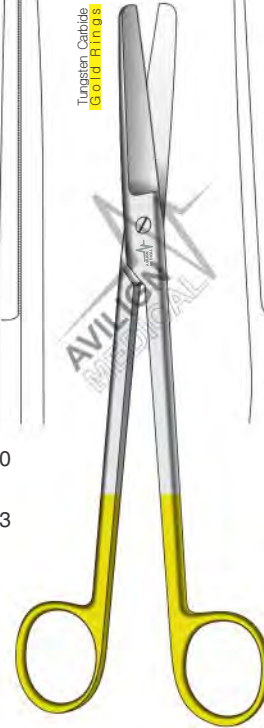

Sims
One Blade Serrated
Blunt/Blunt

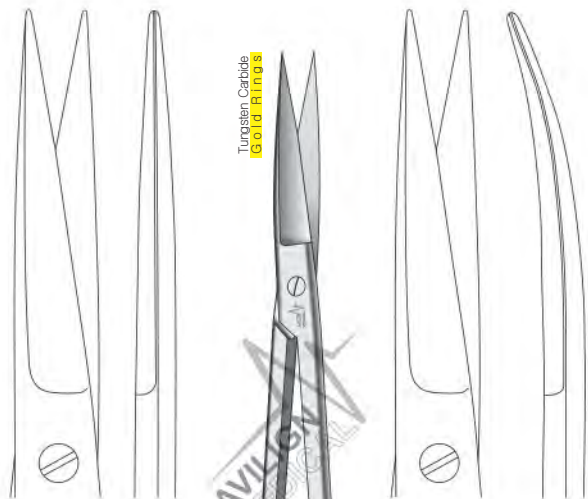

07-0130-20
20 cm / 8"
07-0130-23
23 cm / 9"
Straight

07-0140-20
20 cm / 8"
07-0140-23
23 cm / 9"
Curved

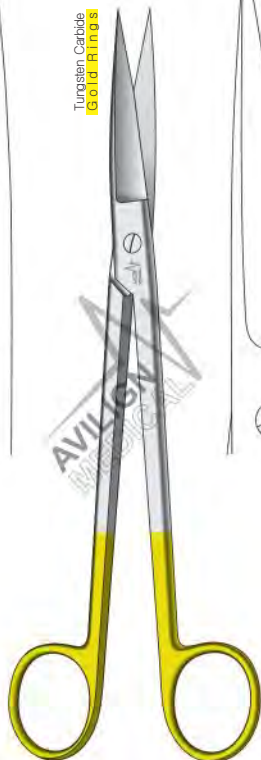

Sims
One Blade Serrated
Sharp/Sharp

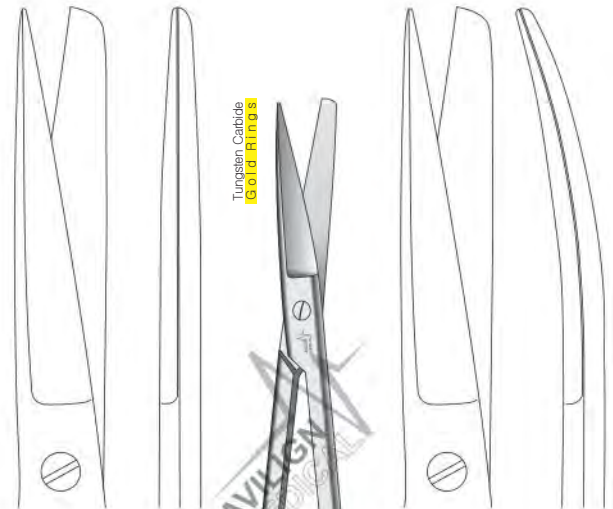

07-0150-20
20 cm / 8"
07-0150-23
23 cm / 9"
Straight

07-0160-20
20 cm / 8"
07-0160-23
23 cm / 9"
Curved

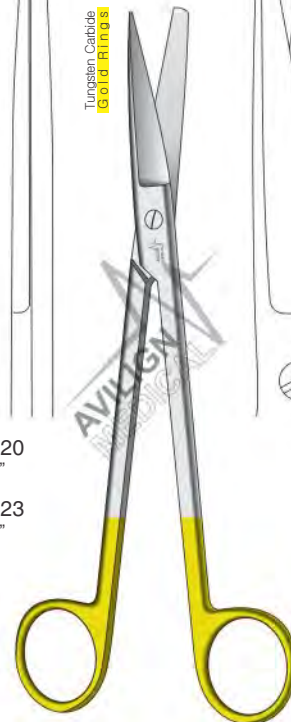

Sims
Sharp/Blunt

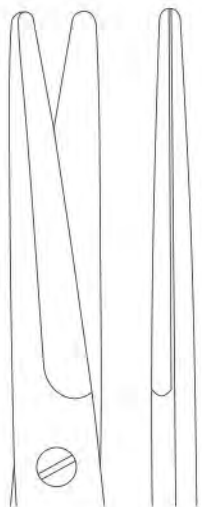

07-0170-14 14 cm / 5½"
 07-0170-17 17 cm / 6¾"
 07-0170-23 23 cm / 9"



Mayo
 Straight

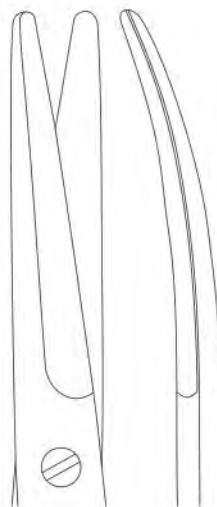

07-0180-14 14 cm / 5½"
 07-0180-17 17 cm / 6¾"
 07-0180-23 23 cm / 9"
 07-0180-36 36 cm / 14¼"
 07-0180-40 40 cm / 16"



Mayo
 Curved

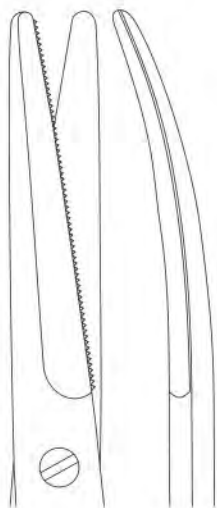

07-0190-17
 17 cm / 6¾"



Mayo
 One Blade Serrated
 Curved

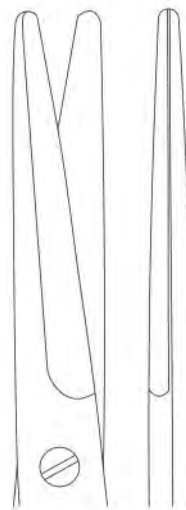

07-0200-22
 22 cm / 8¾"



Mayo-Harrington
 Straight

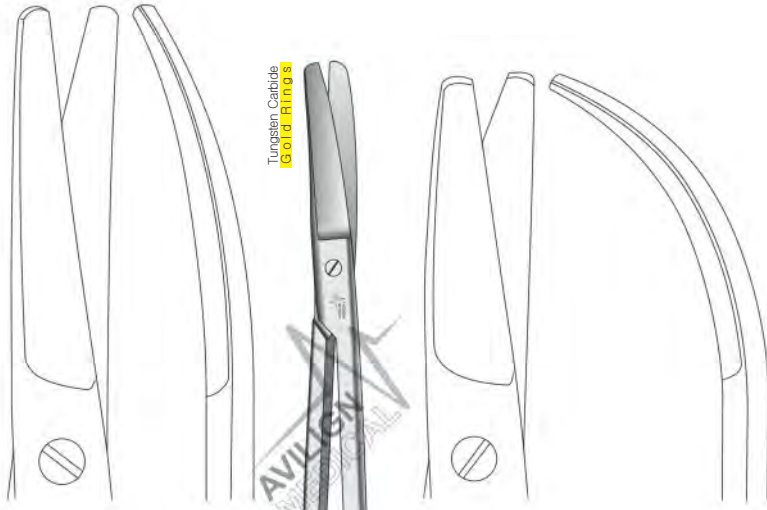

07-0210-22
22 cm / 8¾"
Curved

07-0220-23
23 cm / 9"
Extra Curved

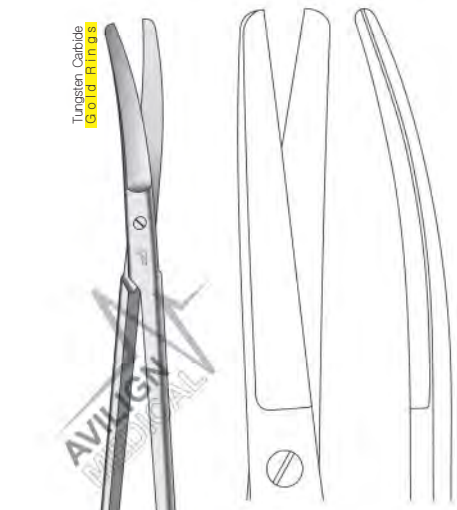
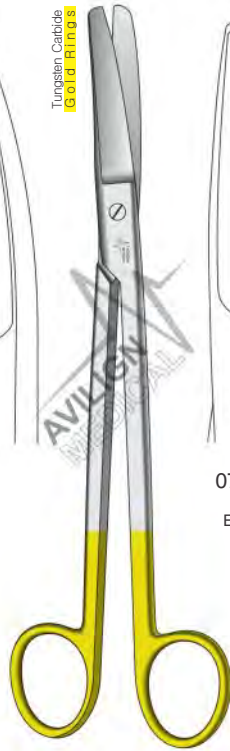

07-0230-23
23 cm / 9"

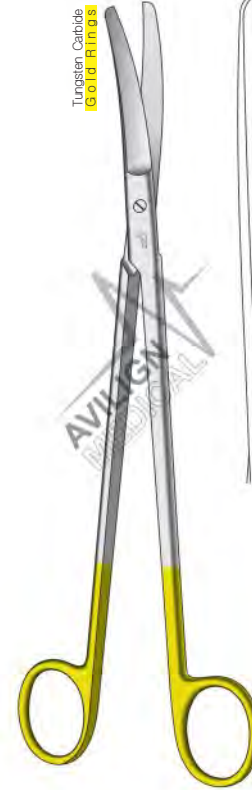

Wertheim
Curved

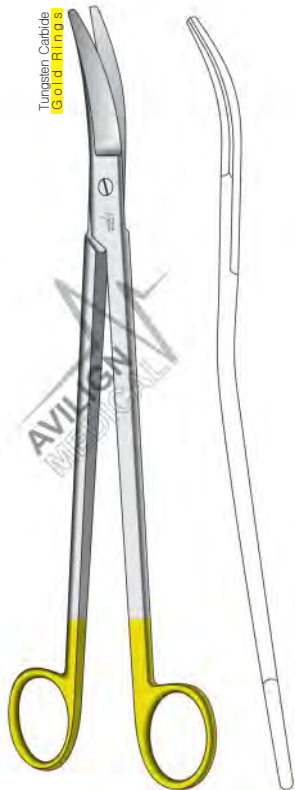

07-0240-25
25 cm / 9¾"
Curved

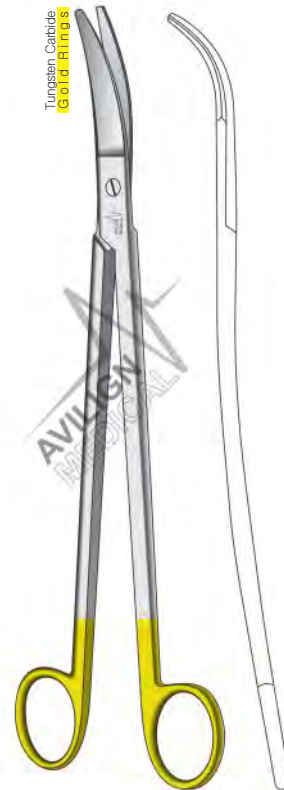

07-0250-25
25 cm / 9¾"
Extra Curved

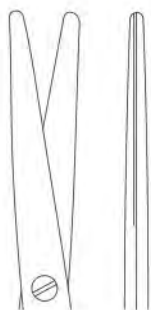

Tungsten Carbide
Gold Rings

- 07-0260-11 11 cm / 4¼"
- 07-0260-14 14 cm / 5½"
- 07-0260-18 18 cm / 7"
- 07-0260-20 20 cm / 8"
- 07-0260-23 23 cm / 9"
- 07-0260-25 25 cm / 9¾"
- 07-0260-28 28 cm / 11"
- 07-0260-30 30 cm / 12"



Metzenbaum
 Straight

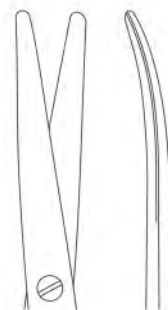

Tungsten Carbide
Gold Rings

- 07-0270-11 11 cm / 4¼"
- 07-0270-14 14 cm / 5½"
- 07-0270-18 18 cm / 7"
- 07-0270-20 20 cm / 8"
- 07-0270-23 23 cm / 9"
- 07-0270-25 25 cm / 9¾"
- 07-0270-28 28 cm / 11"
- 07-0270-30 30 cm / 12"
- 07-0270-36 36 cm / 14¼"
- 07-0270-40 40 cm / 16"

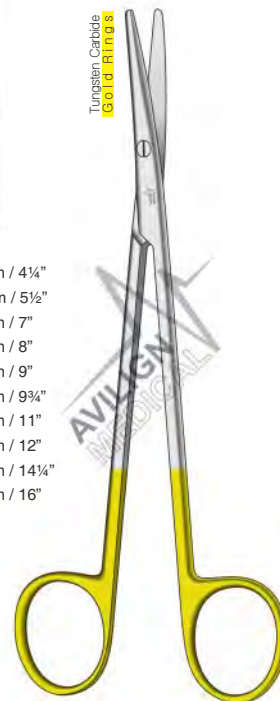

Metzenbaum
 Curved

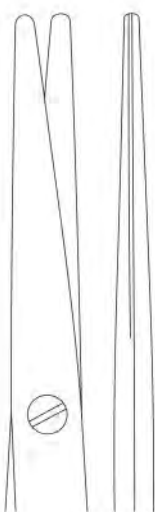

Tungsten Carbide
Gold Rings

- 07-0280-15 15 cm / 6"
- 07-0280-17 17 cm / 6¾"
- 07-0280-21 21 cm / 8¼"



Mayo-Style
 Straight

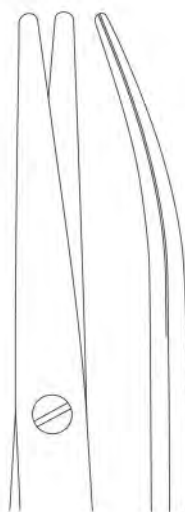

Tungsten Carbide
Gold Rings

- 07-0290-15 15 cm / 6"
- 07-0290-17 17 cm / 6¾"
- 07-0290-21 21 cm / 8¼"

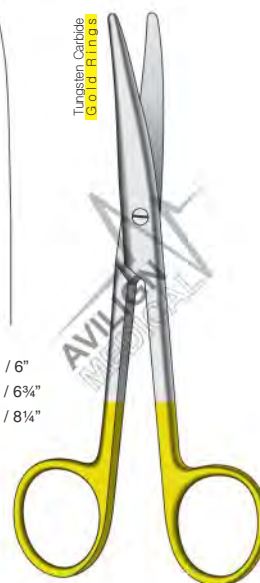

Mayo-Style
 Curved

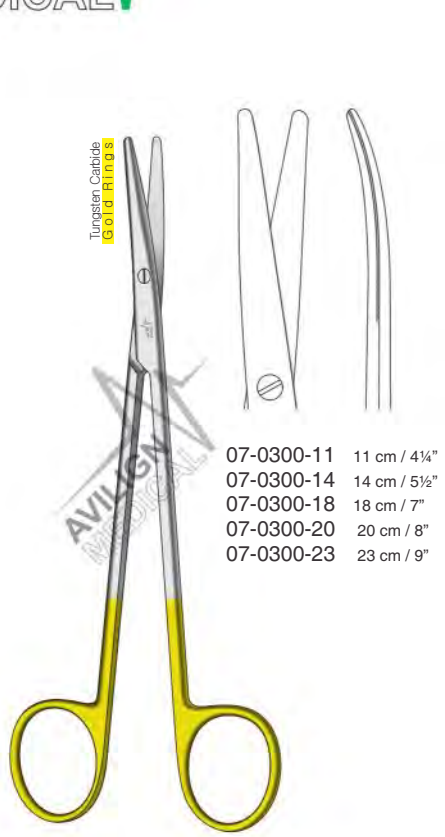

- 07-0300-11 11 cm / 4¼"
- 07-0300-14 14 cm / 5½"
- 07-0300-18 18 cm / 7"
- 07-0300-20 20 cm / 8"
- 07-0300-23 23 cm / 9"

Metzenbaum
One Blade Serrated

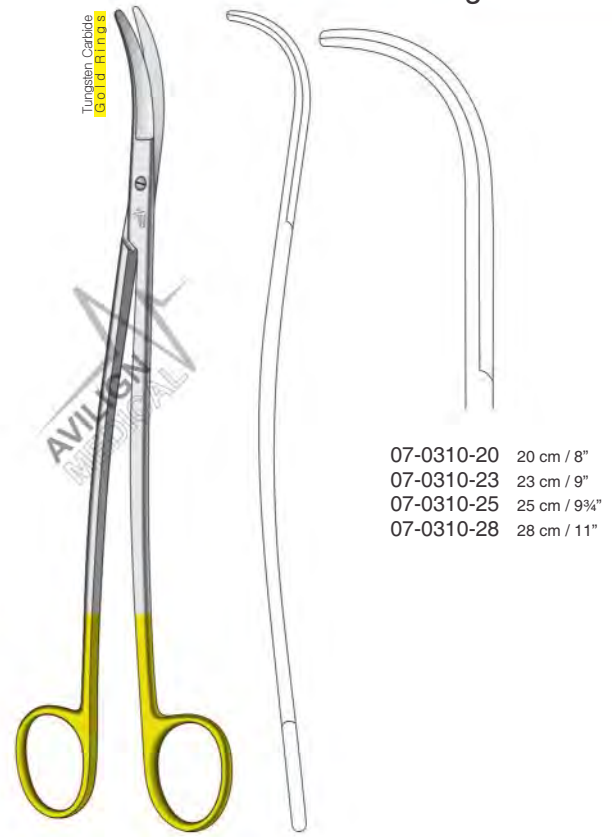

- 07-0310-20 20 cm / 8"
- 07-0310-23 23 cm / 9"
- 07-0310-25 25 cm / 9¾"
- 07-0310-28 28 cm / 11"

Metzenbaum
S-Shape



- 07-0320-23
23 cm / 9"

Metzenbaum

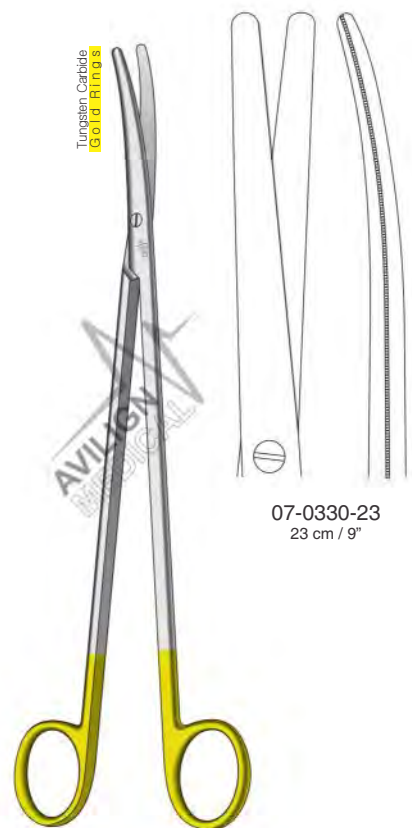

- 07-0330-23
23 cm / 9"

Metzenbaum
One Blade Serrated

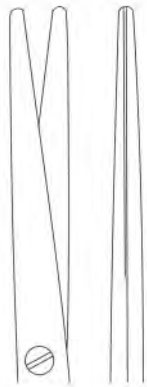

Tungsten Carbide
Gold-Rings



- 07-0340-14 14 cm / 5½"
- 07-0340-18 18 cm / 7"
- 07-0340-20 20 cm / 8"
- 07-0340-23 23 cm / 9"
- 07-0340-25 25 cm / 9¾"
- 07-0340-28 28 cm / 11"

Metzenbaum-Fino
 Straight
 Blunt-Blunt

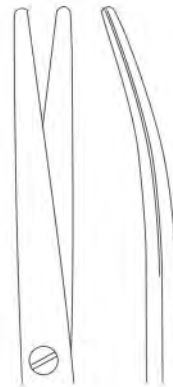

Tungsten Carbide
Gold-Rings

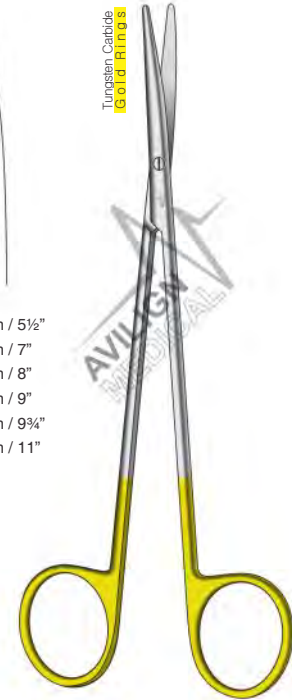

- 07-0350-14 14 cm / 5½"
- 07-0350-18 18 cm / 7"
- 07-0350-20 20 cm / 8"
- 07-0350-23 23 cm / 9"
- 07-0350-25 25 cm / 9¾"
- 07-0350-28 28 cm / 11"

Metzenbaum-Fino
 Curved
 Blunt-Blunt

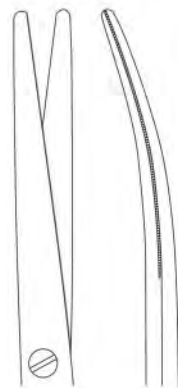

Tungsten Carbide
Gold-Rings



- 07-0360-14 14 cm / 5½"
- 07-0360-18 18 cm / 7"
- 07-0360-20 20 cm / 8"
- 07-0360-23 23 cm / 9"
- 07-0360-25 25 cm / 9¾"
- 07-0360-28 28 cm / 11"

Metzenbaum-Fino
 Curved, One Blade Serrated
 Blunt/Blunt

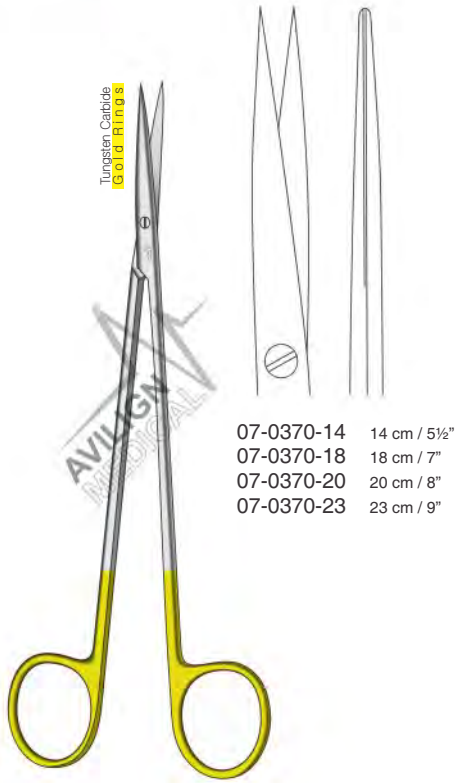

- 07-0370-14 14 cm / 5½"
07-0370-18 18 cm / 7"
07-0370-20 20 cm / 8"
07-0370-23 23 cm / 9"

Metzenbaum-Fino
Straight
Sharp/Sharp

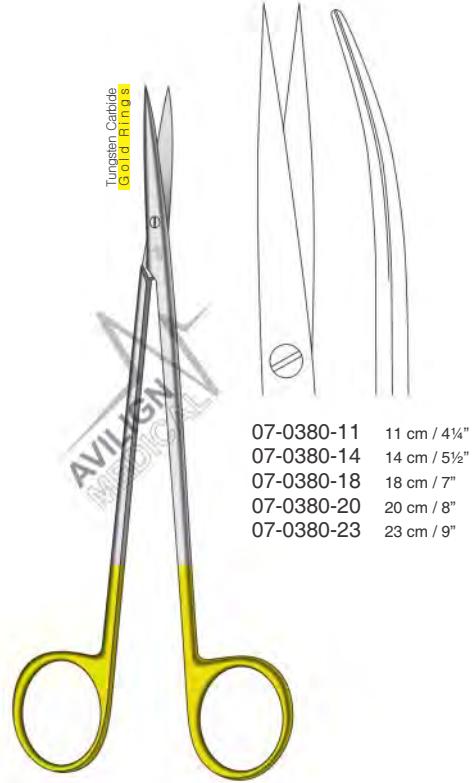

- 07-0380-11 11 cm / 4¼"
07-0380-14 14 cm / 5½"
07-0380-18 18 cm / 7"
07-0380-20 20 cm / 8"
07-0380-23 23 cm / 9"

Metzenbaum-Fino
Curved
Sharp/Sharp

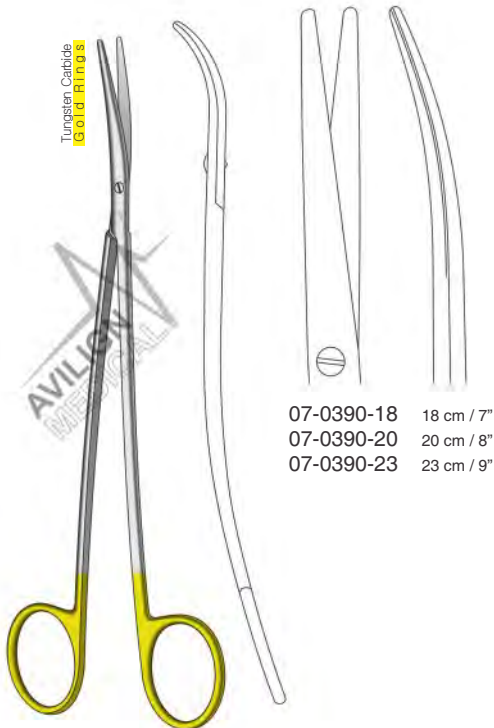

- 07-0390-18 18 cm / 7"
07-0390-20 20 cm / 8"
07-0390-23 23 cm / 9"

Metzenbaum-Fino
S-Shaped
Blunt/Blunt

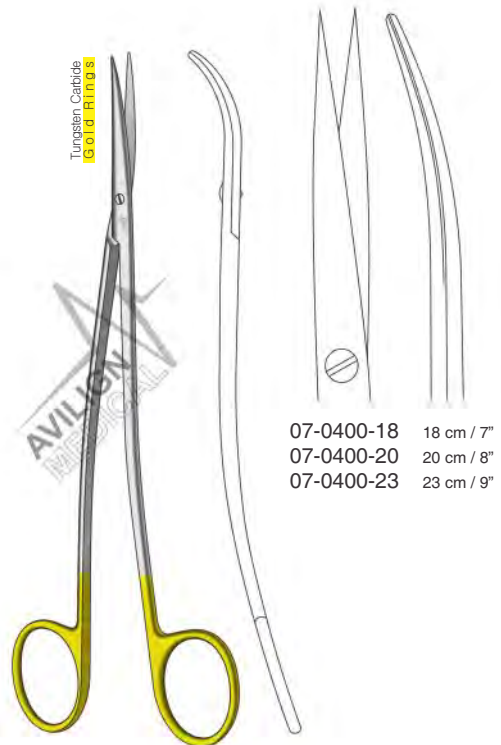

- 07-0400-18 18 cm / 7"
07-0400-20 20 cm / 8"
07-0400-23 23 cm / 9"

Metzenbaum-Fino
S-Shaped
Sharp/Sharp

Präparierscheren
 Tijeras des disección
 Forbici per dissezione
 Dissecting Scissors

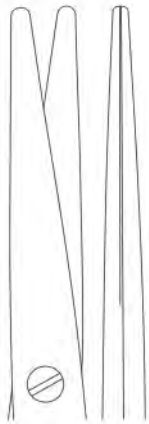

07-0410-16
 16 cm / 6¼"

07-0410-21
 21 cm / 8¼"
 Straight



Mayo-Lexer
 Blunt/Blunt

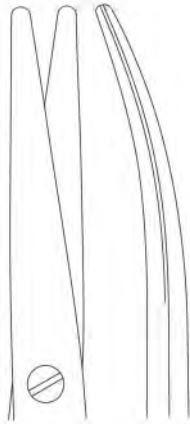

07-0420-16
 16 cm / 6¼"

07-0420-21
 21 cm / 8¼"
 Curved

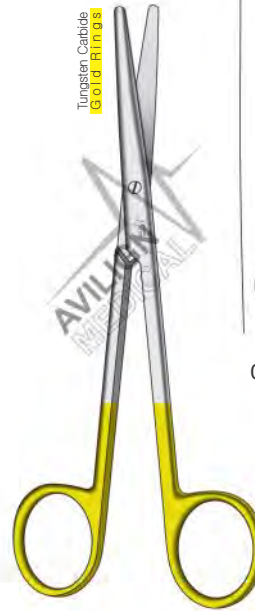

Lexer
 One Blade Serrated
 Blunt/Blunt

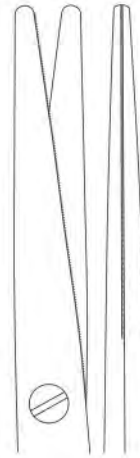

07-0430-16
 16 cm 6¼"

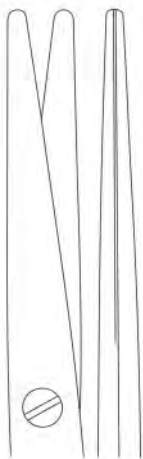

07-0440-16
 Straight



Lexer
 16 cm / 6¼"
 Blunt/Blunt

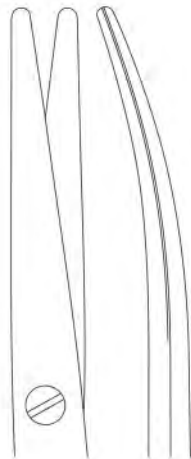

07-0450-16
 Curved



Thorek

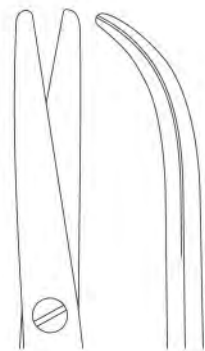

07-0460-20 20 cm / 8"
 07-0460-23 23 cm / 9"
 07-0460-28 28 cm / 11"



07-0470-14
14.5 cm / 5¾"

Joseph
Curved

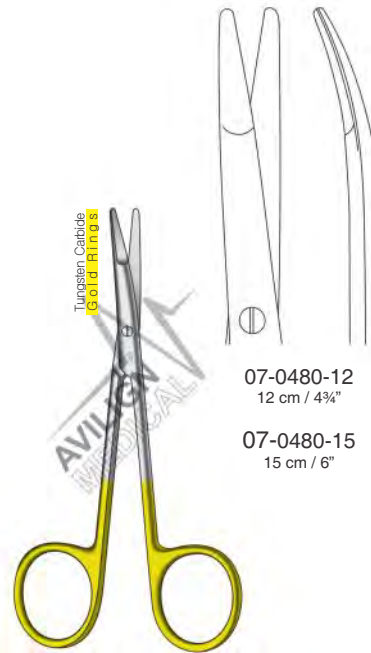

07-0480-12
12 cm / 4¾"

07-0480-15
15 cm / 6"

Kilner
Curved

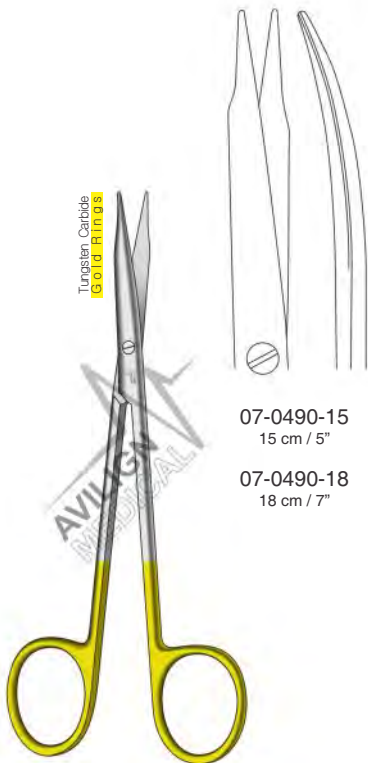

07-0490-15
15 cm / 5"

07-0490-18
18 cm / 7"

Reynolds
Curved

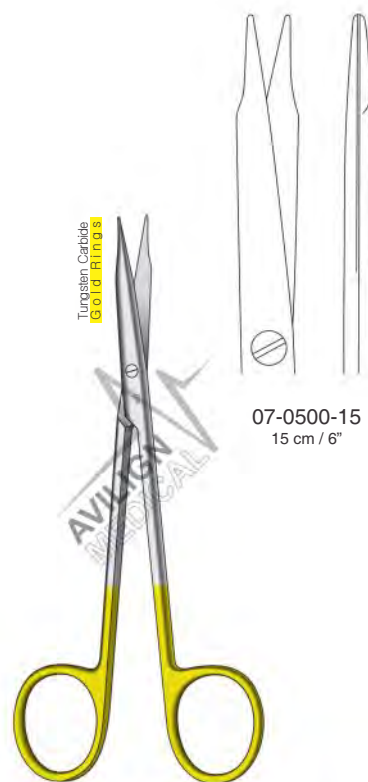

07-0500-15
15 cm / 6"

Reynolds
Straight

Präparierscheren
 Tijeras des disseción
 Forbici per dissezione
 Dissecting Scissors

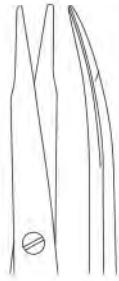

07-0510-13
 13 cm / 5"

07-0510-15
 15 cm / 6"



Jameson
 Curved

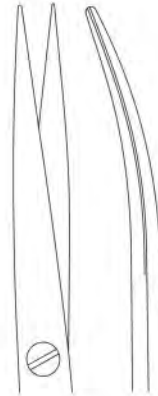

07-0520-14
 14 cm / 5½"



Metzenbaum-Lahey
 Curved
 Sharp / Sharp

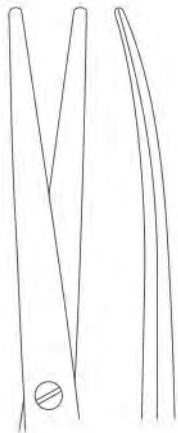

07-0530-20
 20 cm / 8"

07-0530-23
 23 cm / 9"

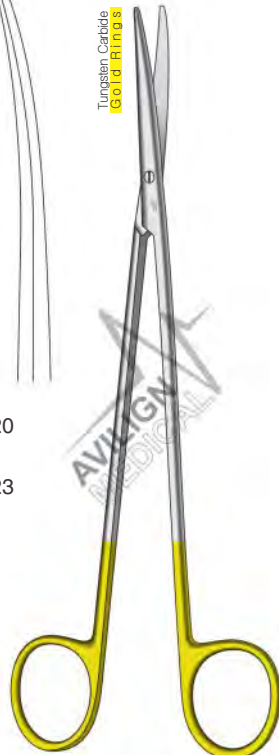

Metzenbaum-Lahey
 Curved
 Blunt / Blunt



07-0540-17
 17.5 cm / 7"

07-0540-20
 20 cm / 8"



Toennis-Adson
 One Blade Serrated
 Curved



07-0550-17
17 cm / 6 3/4"

Dean
Tonsil Scissors
One Blade Serrated



07-0560-13
13 cm / 5"

Fomon
Nasal Scissors

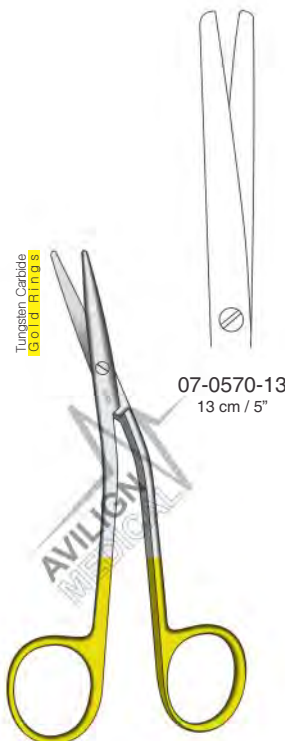

07-0570-13
13 cm / 5"

Fomon
Nasal Scissors

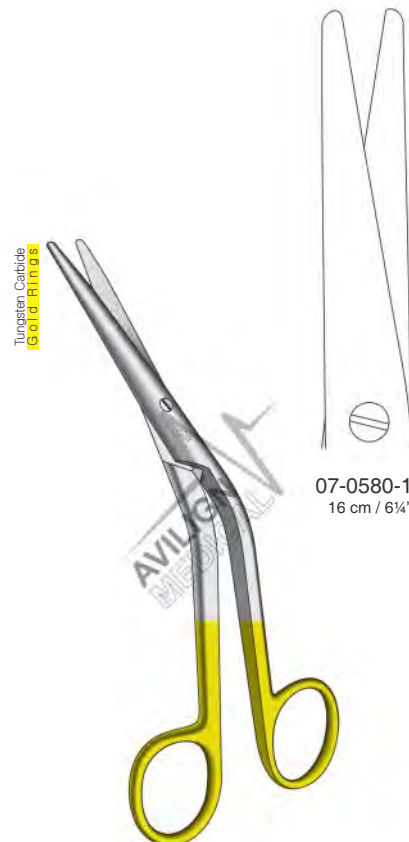

07-0580-16
16 cm / 6 1/4"

Cottle
Nasal Scissors

Face-lift scheren
 Tijeras para Face-lift
 Forbici per Face-lift
 Face-Lift Scissors

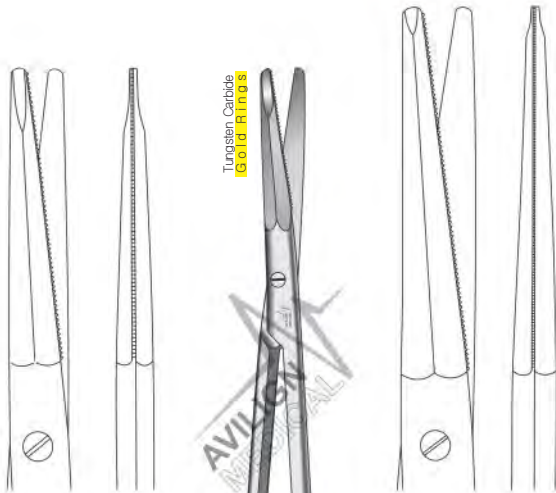

07-0590-20
 20 cm / 8"

07-0600-23
 23 cm / 9"



Gorney
 One Blade Serrated

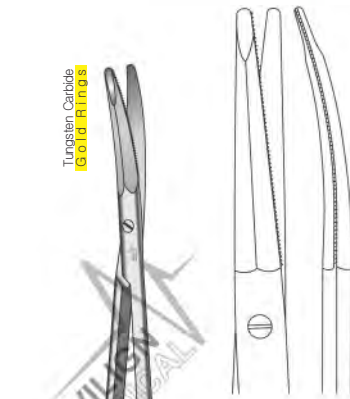

07-0610-15
 14.5 cm / 5 3/4"

07-0610-18
 18 cm / 7"

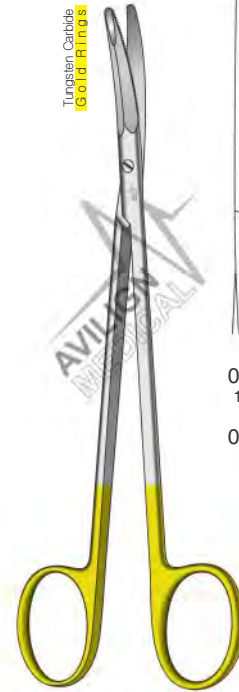

Kaye
 One Blade Serrated

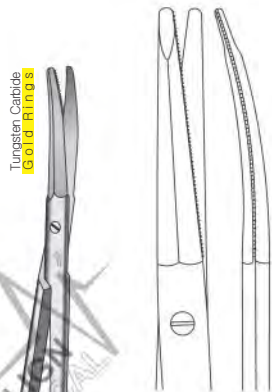

07-0620-18
 18 cm / 7"



Stella
 One Blade Serrated

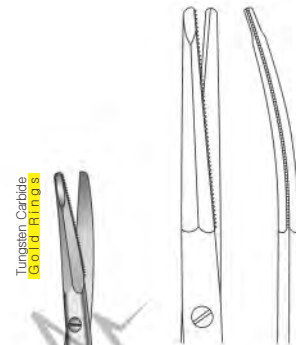

07-0630-14
 14 cm / 5 1/2"



Gregory
 One Blade Serrated

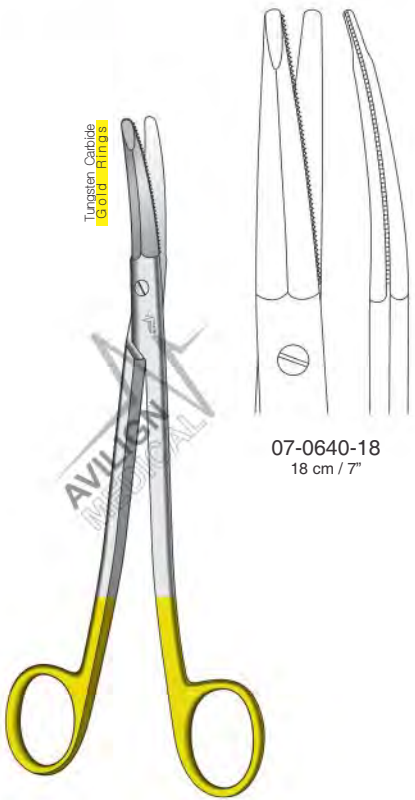

07-0640-18
18 cm / 7"

Freeman-Kaye
One Blade Serrated

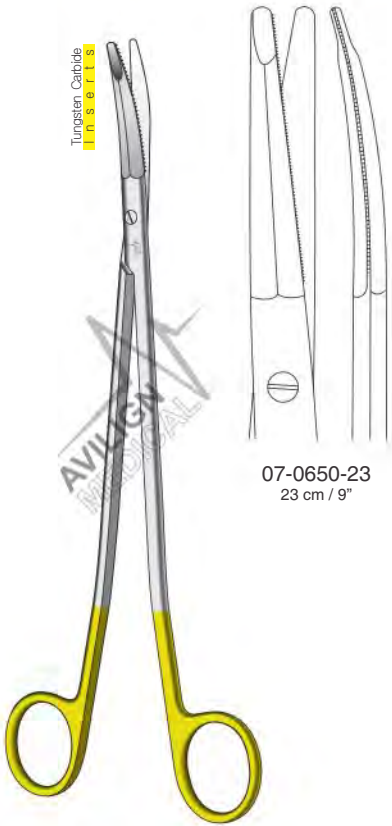

07-0650-23
23 cm / 9"

Freeman-Gorney
One Blade Serrated



07-0660-18
18 cm / 7"

Gorney-Freeman
One Blade Serrated



07-0670-23
23 cm / 9"

Gorney-Freeman
One Blade Serrated

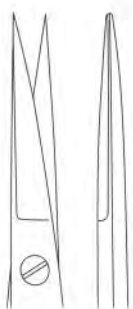

07-0680-16
 Straight

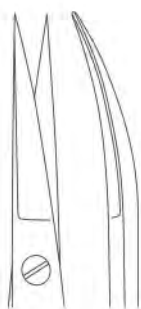

07-0690-16
 Curved



Kelly
 16 cm / 6¼"

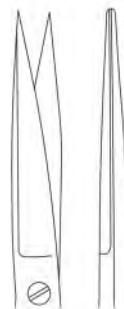

07-0700-14
 Straight

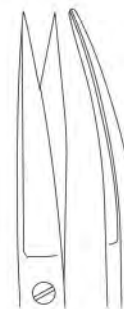

07-0710-14
 Curved

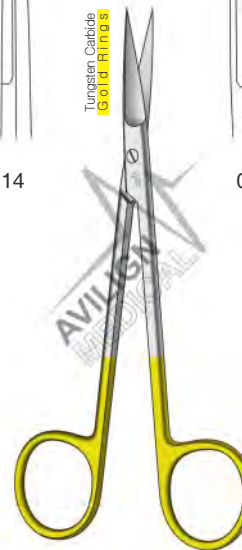

Joseph
 14 cm / 5½"

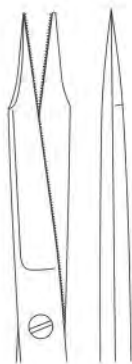

07-0720-13
 Straight

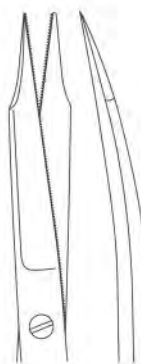

07-0730-13
 Curved



Goldman-Fox
 13 cm / 5"
 One Blade Serrated



07-0740-12
 Straight



07-0750-12
 Curved



Wagner
 12 cm / 4¾"

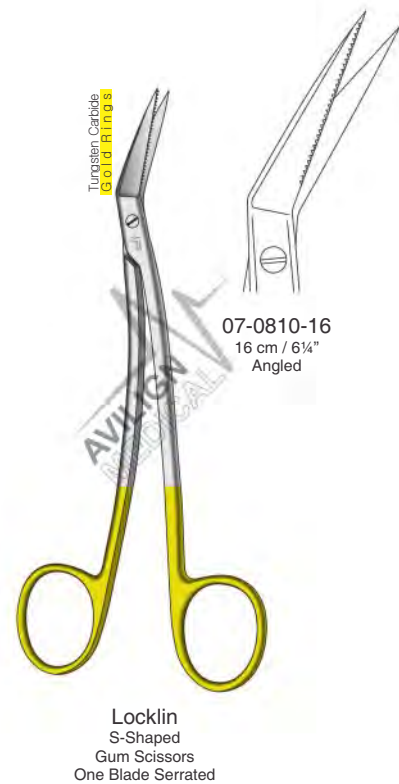
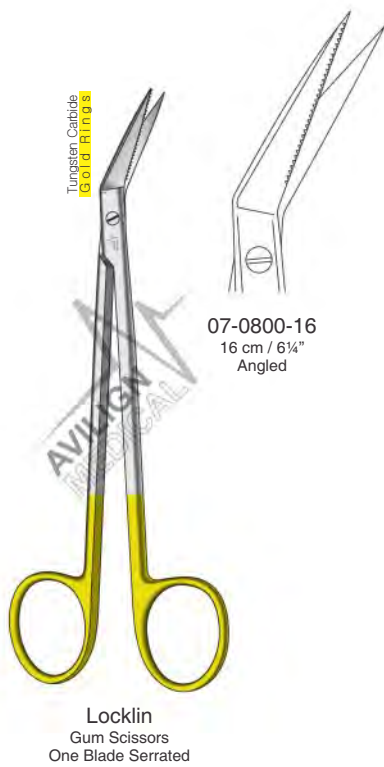
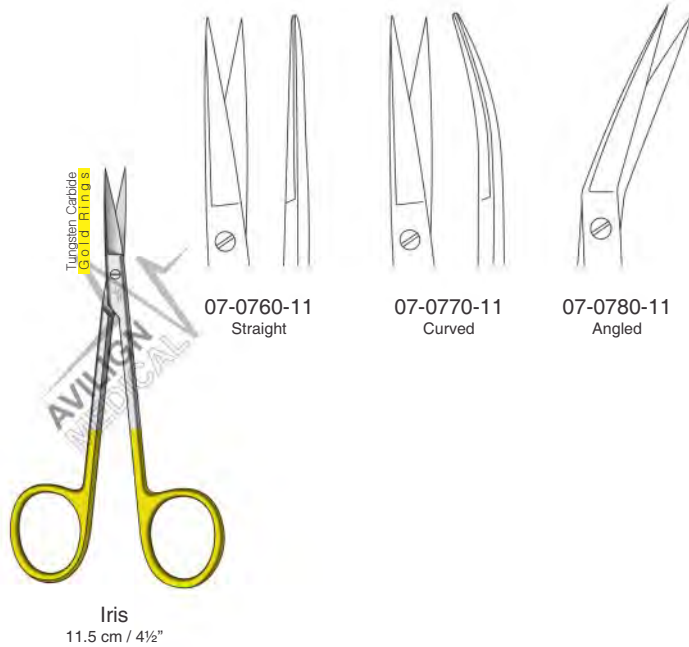

Gefäßscheren, Drahtscheren
 Tijeras vasculares, Cizallas corta-alambres
 Forbici vascolari, Forbici taglia cavo
 Vascular Scissors, Wire Cutting Scissors



07-0820-18 Angled at 25°
 07-0830-18 Angled at 45°
 07-0840-18 Angled at 60°



07-0850-18 Angled at 90°
 07-0860-18 Angled at 125°



Hegemann-Dietrich
 18 cm / 7"
 Vascular Scissors



07-0870-12
 12 cm / 4 3/4"



Universal
 One Blade Serrated

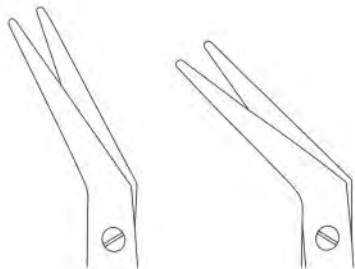

07-0880-16 16 cm / 6 1/4"
 07-0890-16 16 cm / 6 1/4"
 07-0880-23 23 cm / 9"
 Angled at 25°
 07-0890-23 23 cm / 9"
 Angled at 45°

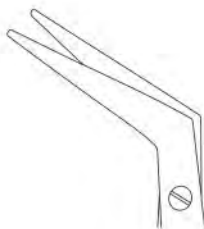

07-0900-16 16 cm / 6 1/4"
 07-0900-23 23 cm / 9"
 Angled at 60°



De Bakey

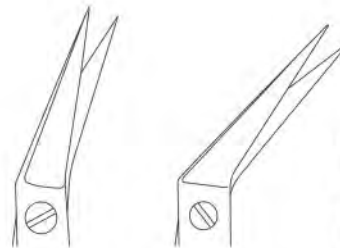

07-0910-19 Angled at 25°
 07-0920-19 Angled at 45°

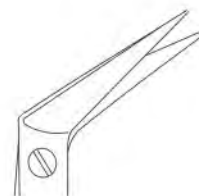

07-0930-19 Angled at 60°

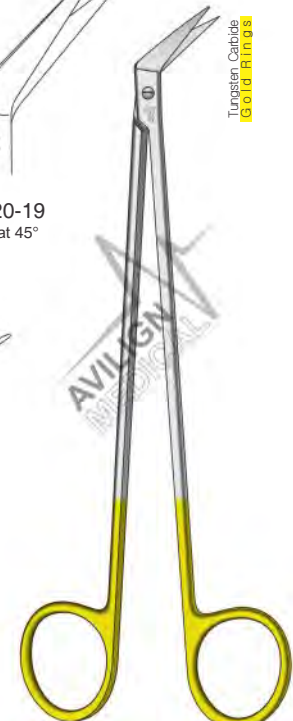

Potts-Smith
 19 cm / 7 1/2"

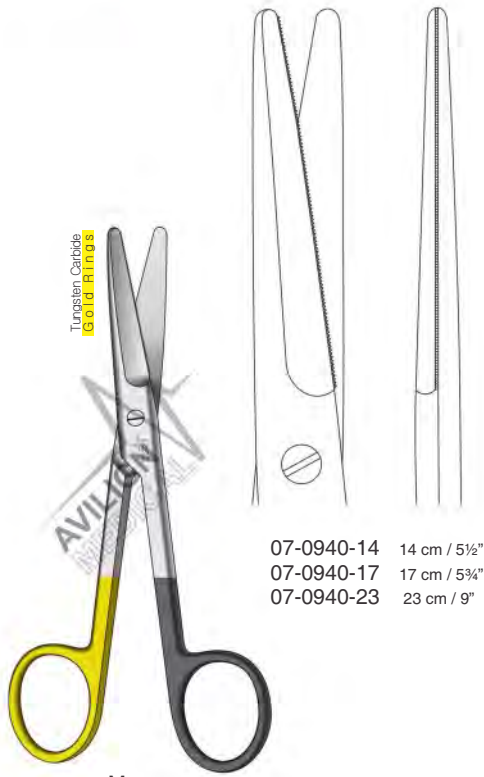

07-0940-14 14 cm / 5½"
07-0940-17 17 cm / 5¾"
07-0940-23 23 cm / 9"

Mayo
One Blade Serrated
Straight



07-0950-14 14 cm / 5½"
07-0950-17 17 cm / 6¾"
07-0950-23 23 cm / 9"

Mayo
One Blade Serrated
Curved



07-0960-14 14 cm / 5½"
07-0960-18 18 cm / 7"
07-0960-20 20 cm / 8"
07-0960-23 23 cm / 9"

Metzenbaum
One Blade Serrated
Straight



07-0970-14 14 cm / 5½"
07-0970-18 18 cm / 7"
07-0970-20 20 cm / 8"
07-0970-23 23 cm / 9"

Metzenbaum
One Blade Serrated
Curved



08

Forceps

Pinzetten

Pinzas

Pinze

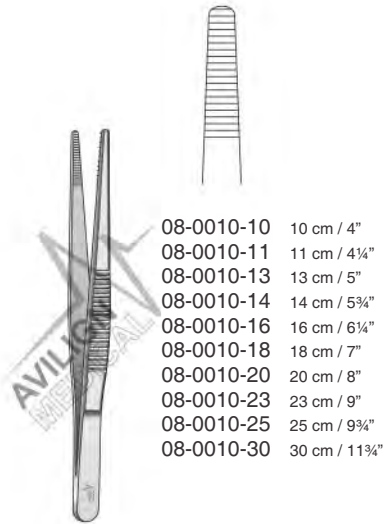

Standard

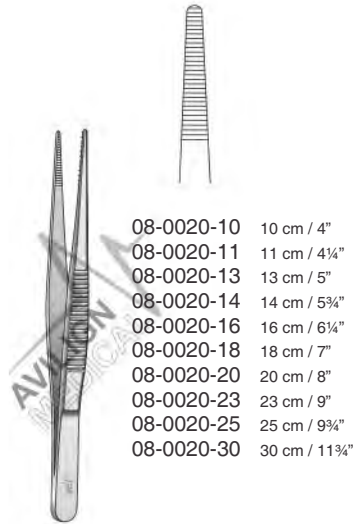

Standard
Narrow

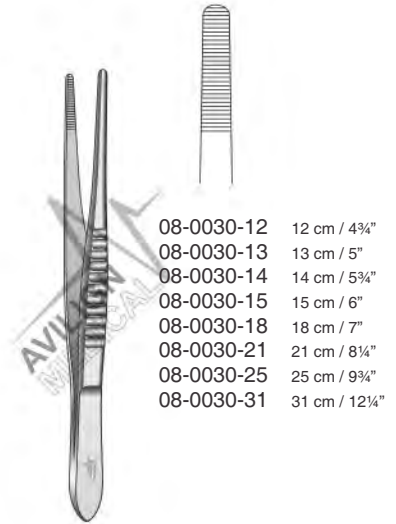

MOD. USA

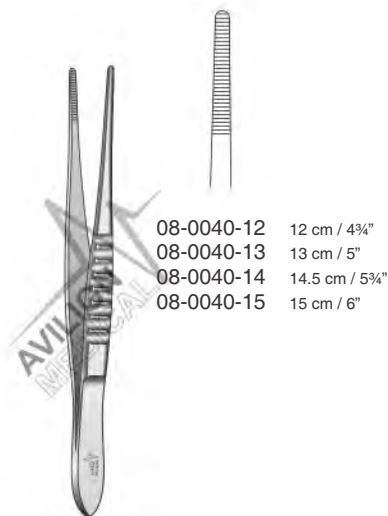

MOD. USA
Narrow

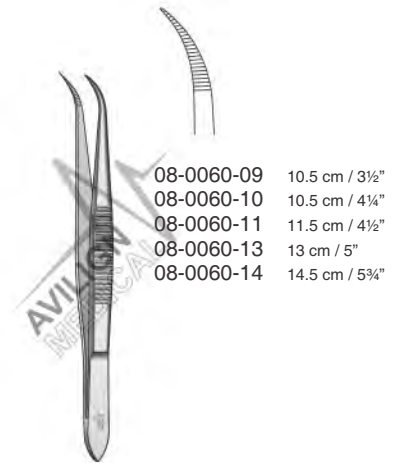
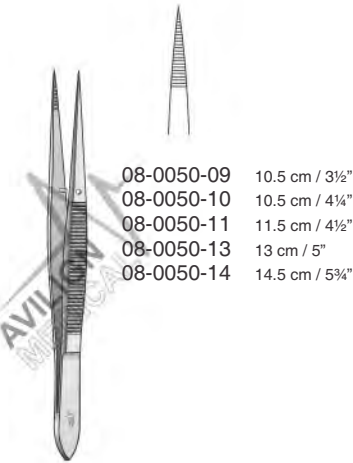



08-0070-12
 12 cm / 4¾"

08-0070-15
 15 cm / 6"



Adson-Micro



08-0080-12
 12 cm / 4¾"



Adson



08-0090-12 12 cm / 4¾"
 08-0090-15 15 cm / 6"
 08-0090-18 18 cm / 7"



Adson



08-0100-12
 12 cm / 4¾"



Adson



08-0110-11
 10 cm / 4"



Bonaccolto
 Suture Forceps
 Narrow



08-0120-05
 0.5 mm



08-0120-07
 0.7 mm



08-0120-10
 1.0 mm



08-0130-05
 0.5 mm



08-0130-07
 0.7 mm



08-0130-10
 1.0 mm



Graefe
 7 cm / 2¾"
 Iris Forceps

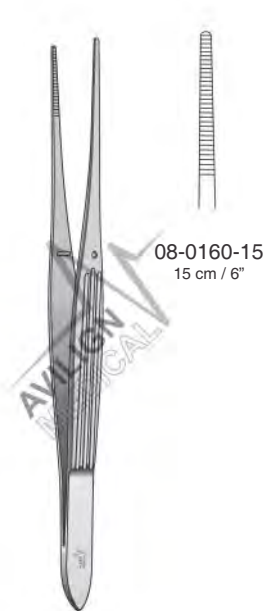

Mc Indoe



Mc Indoe

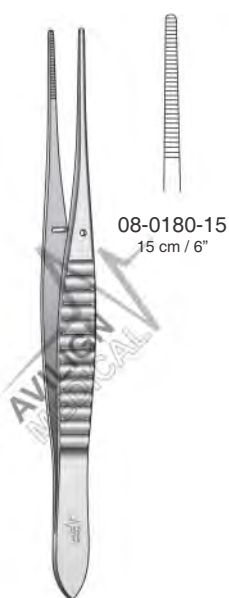

Gillies

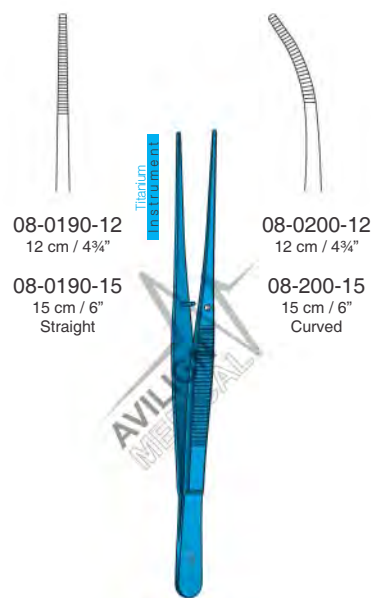

Semken



- 08-0210-18 15 cm / 6"
- 08-0210-20 20 cm / 8"
- 08-0210-25 25 cm / 9 3/4"
- 08-0210-30 30 cm / 11 3/4"



MOD. Russian
 Tissue Grasping Forceps



08-0220-17
 Straight



Cushing
 17 cm / 6 3/4"
 Dissector End



08-0230-17
 Curved



08-0240-18
 18 cm / 7"



Bonney



08-0250-17
 Straight



Taylor
 17 cm / 6 3/4"



08-0260-17
 Curved



15.5 cm / 6"



08-0270-06
 0.6 mm



08-0270-08
 0.8 mm



08-0270-10
 1.0 mm

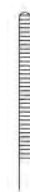

08-0280-17
 17 cm / 6 3/4"



Taylor



08-0290-18 18 cm / 7"
08-0290-21 21 cm / 8¼"
08-0290-25 25 cm / 9¾"
08-0290-30 30 cm / 11¾"
Straight



Potts-Smith



08-0300-18 18 cm / 7"
08-0300-21 21 cm / 8¼"
08-0300-25 25 cm / 9¾"
08-0300-30 30 cm / 11¾"
Curved



Duval
Tissue Forceps



08-0310-14
14 cm / 5½"



08-0320-18
18 cm / 7"



Gerald
Curved



08-0330-18 18 cm / 7"
08-0330-23 23 cm / 9"



Gerald
Straight



08-0340-19
19 cm / 7½"



Dennis-Browne
Tissue Grasping Forceps

Chirurgische Pinzetten
 Pinzas quirúrgicas
 Pinze per chirurgia
 Tissue Forceps



- 08-0350-10 10 cm / 4"
- 08-0350-11 11 cm / 4¼"
- 08-0350-13 13 cm / 5"
- 08-0350-14 14 cm / 5½"
- 08-0350-16 16 cm / 6¼"
- 08-0350-18 18 cm / 7"
- 08-0350-20 20 cm / 8"
- 08-0350-23 23 cm / 9"
- 08-0350-25 25 cm / 9¾"
- 08-0350-30 30 cm / 11¾"



Standard
1 x 2 Teeth



- 08-0360-11 11 cm / 4¼"
- 08-0360-13 13 cm / 5"
- 08-0360-14 14 cm / 5½"
- 08-0360-16 16 cm / 6¼"
- 08-0360-18 18 cm / 7"
- 08-0360-20 20 cm / 8"
- 08-0360-25 25 cm / 9¾"
- 08-0360-30 30 cm / 11¾"



Standard
Narrow
1 x 2 Teeth



- 08-0370-13 13 cm / 5"
- 08-0370-14 14 cm / 5½"
- 08-0370-16 16 cm / 6¼"
- 08-0370-18 18 cm / 7"
- 08-0370-20 20 cm / 8"



Standard
Delicate
1 x 2 Teeth



- 08-0380-18 18 cm / 7"
- 08-0380-20 20 cm / 8"
- 08-0380-25 25 cm / 9¾"
- 08-0380-30 30 cm / 11¾"



Waugh
1 x 2 Teeth



- 08-0390-11 11 cm / 4¼"
- 08-0390-13 13 cm / 5"
- 08-0390-14 14 cm / 5½"
- 08-0390-15 15 cm / 6"
- 08-0390-18 18 cm / 7"
- 08-0390-20 20 cm / 8"
- 08-0390-25 25 cm / 9¾"
- 08-0390-30 30 cm / 11¾"



MOD. USA
2 x 3 Teeth



- 08-0400-12 12 cm / 4¾"
- 08-0400-13 13 cm / 5"
- 08-0400-14 14 cm / 5½"
- 08-0400-15 15 cm / 6"
- 08-0400-18 18 cm / 7"
- 08-0400-21 21 cm / 9¼"
- 08-0400-25 25 cm / 9¾"
- 08-0400-30 30 cm / 11¾"



MOD. USA
1 x 2 Teeth



Cushing
1 x 2 Teeth
Dissector End

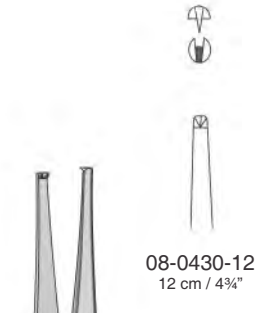

Treves
1 x 2 Teeth

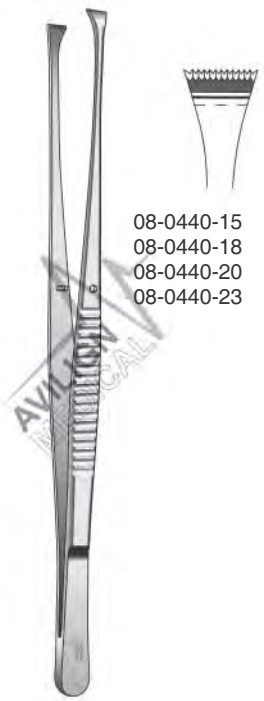

Nelson
6 x 7 Teeth
Lung Grasping Forceps

- 08-0440-15 15 cm / 6"
- 08-0440-18 18 cm / 7"
- 08-0440-20 20 cm / 8"
- 08-0440-23 23 cm / 9"



08-0450-17
17 cm / 6 3/4"

70 Cushing-Brown
Dissector End

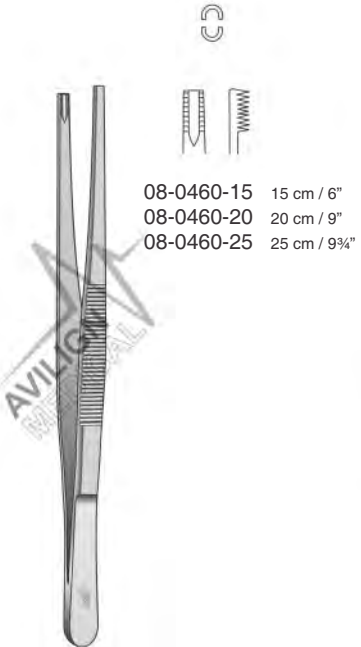

Brown
Tissue Grasping Forceps

- 08-0460-15 15 cm / 6"
- 08-0460-20 20 cm / 9"
- 08-0460-25 25 cm / 9 3/4"

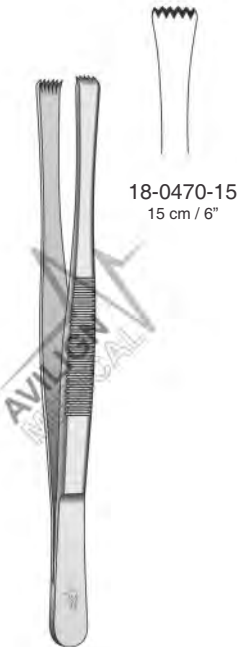

Lerche
5 x 6 Teeth

18-0470-15
15 cm / 6"

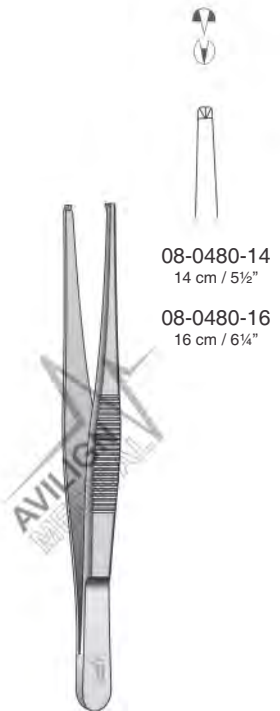

Standard
1 x 2 Teeth

- 08-0480-14 14 cm / 5 1/2"
- 08-0480-16 16 cm / 6 1/4"

Chirurgische Pinzetten
 Pinzas quirúrgicas
 Pinze per chirurgia
 Tissue Forceps



08-0490-05
 0.5 mm Tip
 Straight



08-0490-07
 0.7 mm Tip
 Straight



08-0490-10
 1.0 mm Tip
 Straight



08-0510-07
 7 cm / 2¾"



08-0520-07
 7 cm / 2¾"

08-0510-10
 10 cm / 4"
 Straight

08-0520-10
 10 cm / 4"
 Extra Curved



08-0500-05
 0.5 mm Tip
 Curved



08-0500-07
 0.7 mm Tip
 Curved



08-0500-10
 1.0 mm Tip
 Curved



08-0530-07
 7 cm / 2¾"

08-0530-10
 10 cm / 4"
 Curved



Graefe
 7 cm / 2¾"
 1 x 2 Teeth
 Iris Forceps



Graefe
 1 x 2 Teeth
 1 mm
 Iris Forceps



08-0540-01
 Straight



08-0540-02
 Curved



08-0540-03
 10.5 cm / 4"
 Extra Curved



Stevens
 10.5 cm / 4"
 1 x 2 Teeth
 Iris Forceps



08-0550-10
 10 cm / 4"

08-0550-11
 11 cm / 4¼"



1 x 2 Teeth
 0.7 mm Tip



08-0560-12
 12.5 cm / 5"

08-0560-14
 14.5 cm / 5¾"



Semken
 1 x 2 Teeth
 0.7 mm



08-0570-12
12 cm / 4¾"

Adson-Brown
9 X 9 Teeth

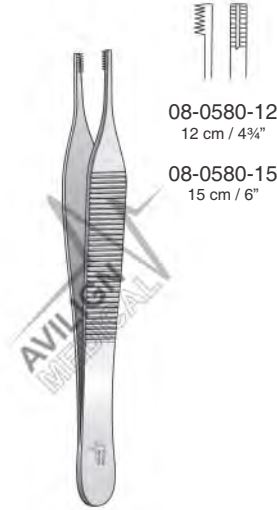

08-0580-12
12 cm / 4¾"

08-0580-15
15 cm / 6"

Adson-Brown
7 X 7 Teeth

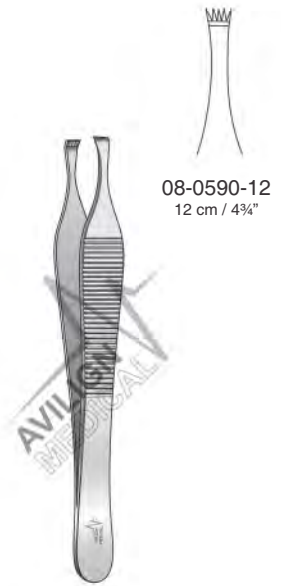

08-0590-12
12 cm / 4¾"

Adson-Brown

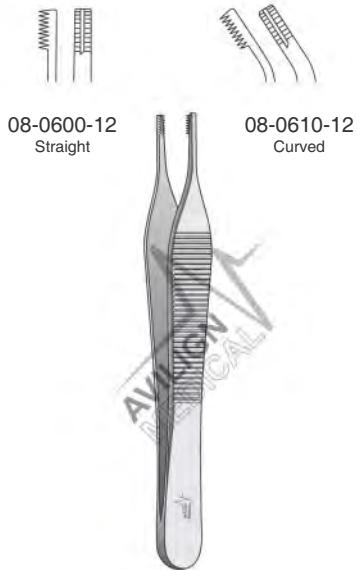

08-0600-12
Straight

08-0610-12
Curved

Adson-Brown
12 cm / 4¾"
9 x 9 Teeth

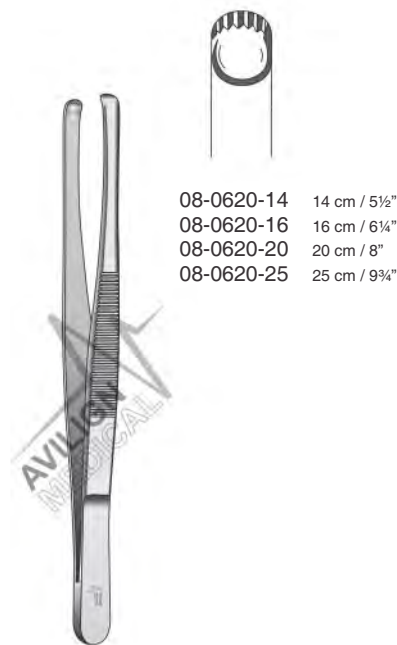

08-0620-14 14 cm / 5½"
08-0620-16 16 cm / 6¼"
08-0620-20 20 cm / 8"
08-0620-25 25 cm / 9¾"

Durante
6 x 7 Teeth
Vascular & Tumor Forceps

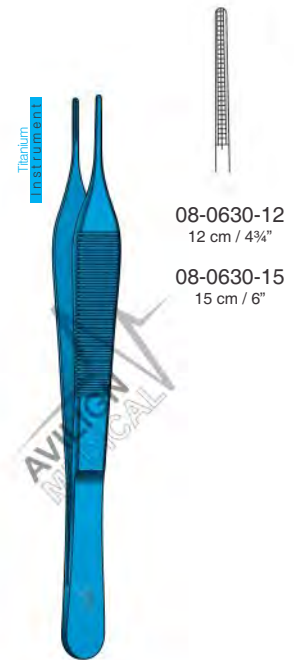

08-0630-12
12 cm / 4¾"

08-0630-15
15 cm / 6"

Adson-De Bakey
1.5 mm



08-0640-10
 10 cm / 4"

Graefe
 Tissue Grasping Forceps

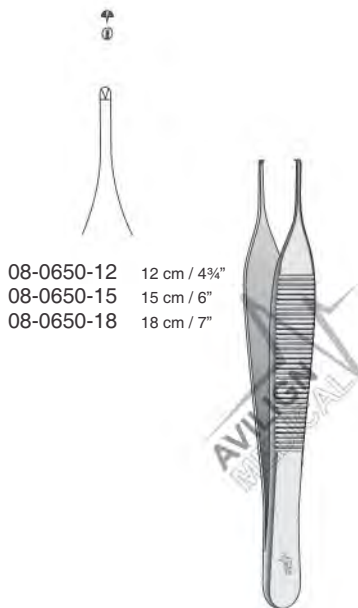

08-0650-12 12 cm / 4 3/4"
 08-0650-15 15 cm / 6"
 08-0650-18 18 cm / 7"

Adson
 1 x 2 Teeth



08-0660-12
 12 cm / 4 3/4"

Adson
 1 x 2 Teeth

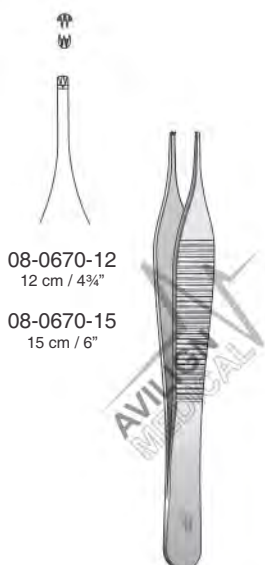

08-0670-12
 12 cm / 4 3/4"
 08-0670-15
 15 cm / 6"

Adson
 2 x 3 Teeth

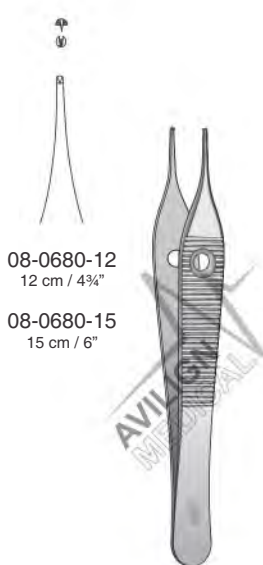

08-0680-12
 12 cm / 4 3/4"
 08-0680-15
 15 cm / 6"

Adson-Micro
 1 x 2 Teeth

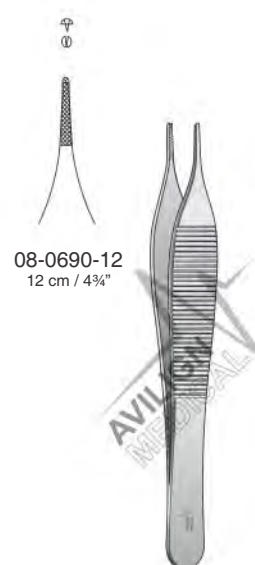

08-0690-12
 12 cm / 4 3/4"

Adson-Mini
 1 x 2 Teeth



De Bakey



1.0 mm



1.5 mm

08-0700-16	16.5 cm / 6½"	08-0710-16
08-0700-20	20 cm / 8"	08-0710-20
08-0700-24	24 cm / 6½"	08-0710-24
	30 cm / 11¾"	08-0710-30



1.5 mm



2.0 mm



2.0 mm

08-0720-16	16.5 cm / 6½"	08-0730-16	08-0740-16	16.5 cm / 6½"
08-0720-20	20 cm / 8"	08-0730-20	08-0740-20	20 cm / 8"
08-0720-24	24 cm / 6½"	08-0730-24	08-0740-24	24 cm / 6½"
08-0720-30	30 cm / 11¾"	08-0730-30	08-0740-30	30 cm / 11¾"

Atraumatische Pinzetten
 Pinzas atrauma
 Pinze atraumatiche
 Non-Traumatic Tissue Forceps



08-0750-15	16.5 cm / 6½"	08-0760-15	08-0770-15	16.5 cm / 6½"	08-0780-15	08-0790-15
08-0750-20	20 cm / 8"	08-0760-20	08-0770-20	20 cm / 8"	08-0780-20	08-0790-20
08-0750-24	24 cm / 9½"	08-0760-24	08-0770-24	24 cm / 9½"	08-0780-24	08-0790-24
				30 cm / 11¾"	08-0780-30	08-0790-30



De Bakey

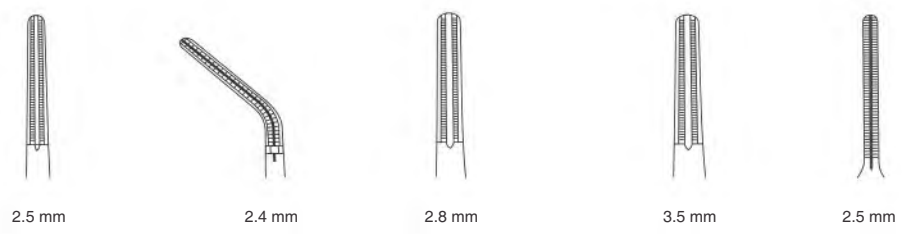

08-0800-16	16.5 cm / 6½"	08-0810-20	08-0820-16	16.5 cm / 6½"	08-0830-16	Cooley	08-0840-16
08-0800-20	20 cm / 8"		08-0820-20	20 cm / 8"	08-0830-20		08-0840-20
08-0800-24	24 cm / 9½"		08-0820-24	24 cm / 9½"	08-0830-24		08-0840-24
08-0800-30	30 cm / 11¾"		08-0820-30	30 cm / 11¾"	08-0830-30		



De Bakey

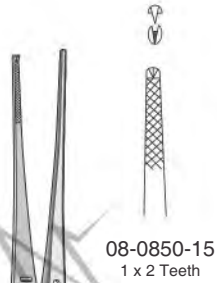

Gillies
15 cm / 6"

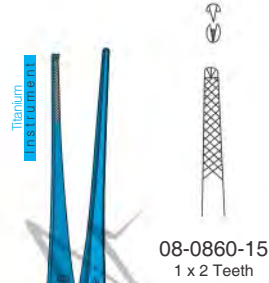

Gillies
15 cm / 6"

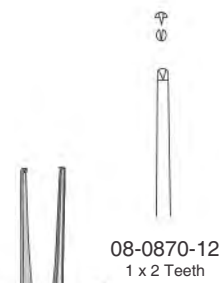

Semken
12.5 cm / 5"

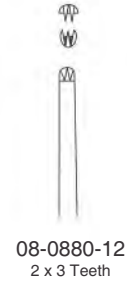

Taylor
1 x 2 Teeth
Dissector End



Taylor
1 x 2 Teeth
Dissector End

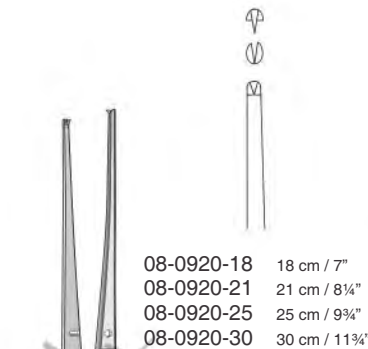

Potts-Smith
1 x 2 Teeth
Straight

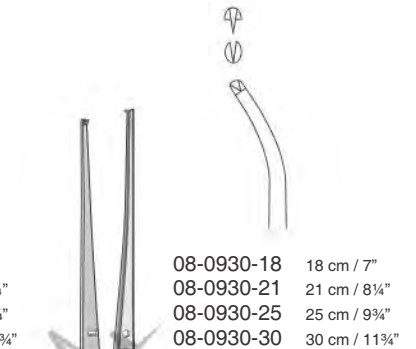

Potts-Smith
1 x 2 Teeth
Curved

Ohr - und Nasenpinzetten
 Pinzas auriculares y nasales
 Pinze auricolari e nasali
 Ear & Nasal Dressing Forceps



08-0940-11 11 cm / 4¼"
 08-0940-12 12 cm / 4¾"
 08-0940-15 15 cm / 6"
 08-0940-18 18 cm / 7"



Troeltsch



08-0950-12 12 cm / 4¾"
 08-0950-15 15 cm / 6"
 08-0950-17 17 cm / 6¾"



Troeltsch
 1 x 2 Teeth



08-0960-14
 14 cm / 5½"



Lucae



08-0970-14
 14 cm / 5½"



Lucae
 1 x 2 Teeth



08-0980-16 16 cm / 6¼"
 08-0980-18 18 cm / 7"
 08-0980-20 20 cm / 8"



Lucae



08-0990-20
 20 cm / 8"



Gruenwald-Jansen



08-1000-16 16 cm / 6¼"
 08-1000-18 18 cm / 7"
 08-1000-20 20 cm / 8"



Gruenwald-Jansen
 1 x 2 Teeth



08-1010-08 8 cm / 3"
08-1010-09 9 cm / 3½"
08-1010-10 10 cm / 4"
08-1010-11 11 cm / 4¼"
08-1010-12 12 cm / 4¾"
08-1010-14 14 cm / 5½"
Straight

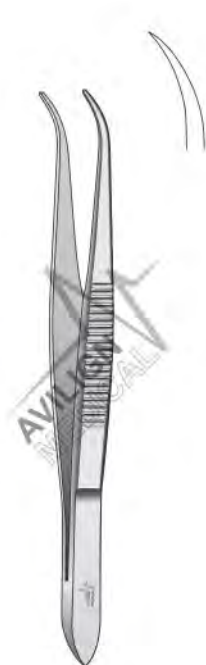

08-1020-08 8 cm / 3"
08-1020-09 9 cm / 3½"
08-1020-10 10 cm / 4"
08-1020-11 11 cm / 4¼"
08-1020-12 12 cm / 4¾"
08-1020-14 14 cm / 5½"
Curved



Douglas
08-1030-09
9 cm / 3½"



08-1040-09
9 cm / 3½"



Littauer
08-1050-08
8.5 cm / 3"

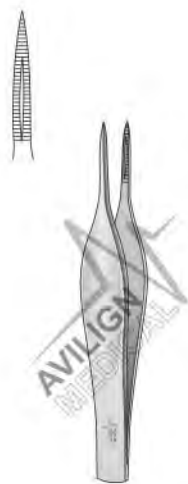

Feilchenfeld
 08-1060-07 7.5 cm / 3"
 08-1060-09 9 cm / 3½"
 08-1060-11 11.5 cm / 4½"



Feilchenfeld
 08-1070-07 7.5 cm / 3"
 08-1070-09 9 cm / 3½"
 08-1070-11 11.5 cm / 4½"



08-1080-09
 9.5 cm / 3¾"
 1 x 2 Teeth



08-1090-05
 0.5 mm

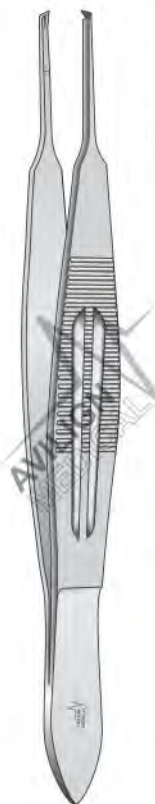

08-1090-09
 0.9 mm

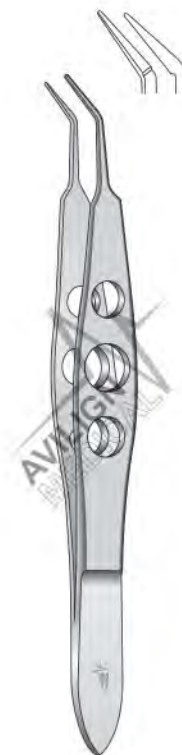

Kelman-Mc Pherson
 08-1100-10



08-1110-02
12 cm / 4 3/4"



08-1120-03
12 cm / 4 3/4"



08-1130-08
11.5 cm / 4 1/2"
0.4 mm Tip



08-1140-09
13.5 cm / 5 1/4"
0.4 mm Tip



09

TC Forceps

Pinzetten mit Hartmetalleinlagen
Pinzas con bocas de carburo tungsteno
Pinze con morsi in carburo di tungsteno

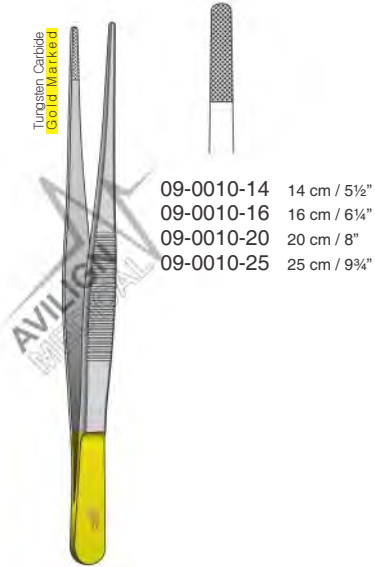

Standard

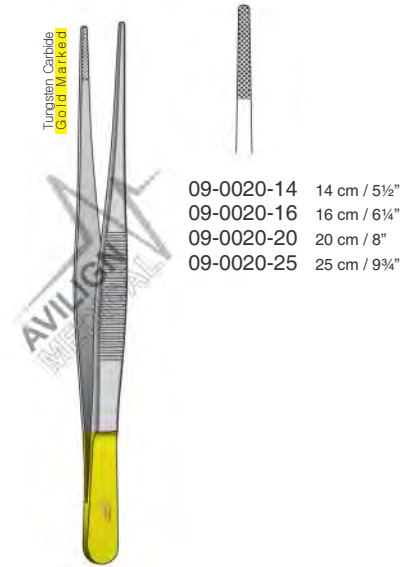

Standard
Delicate

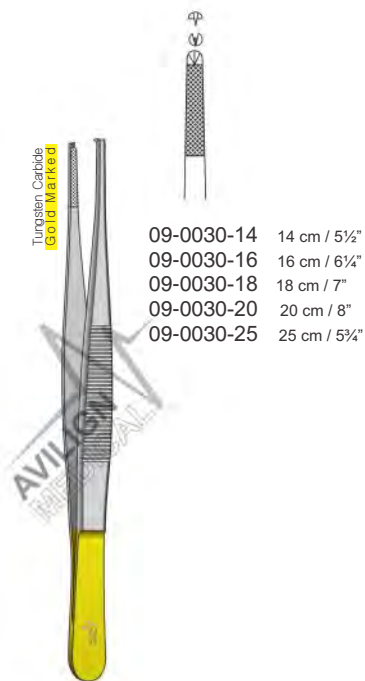

Standard
1 x 2 Teeth



Mc Indoe

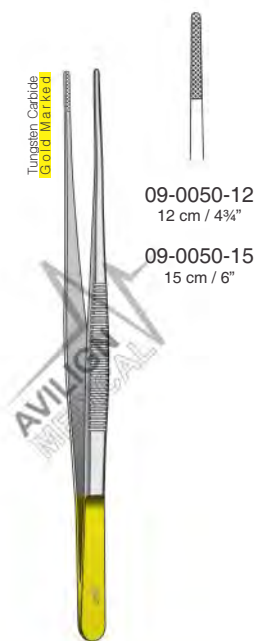

Semken

Pinzetten mit Hartmetalleinsätzen
 Pinzas con bocas de carburo tungsteno
 Pinze con morsi in carburo di tungsteno
 Tungsten Carbide Dissecting Forceps



Cushing
 Dissector End

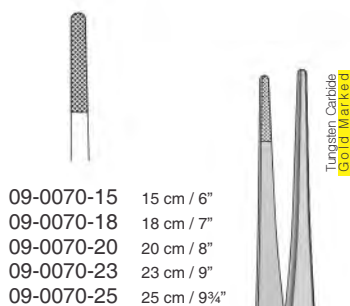

Potts-Smith

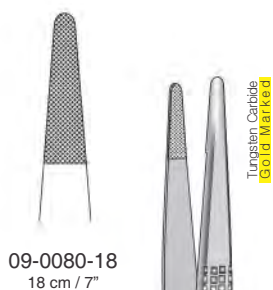

Bonney

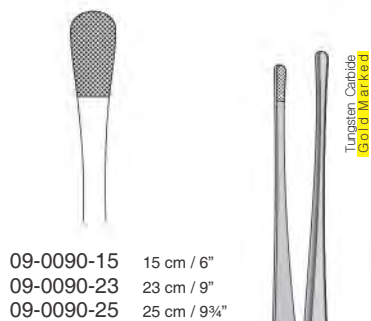

Wangenstein

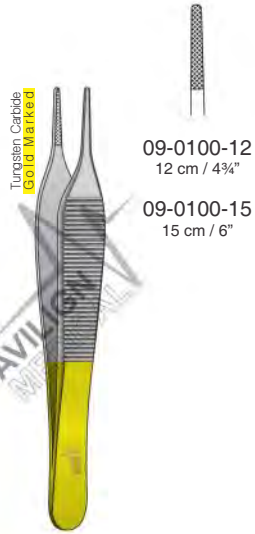

Adson



Adson-Micro

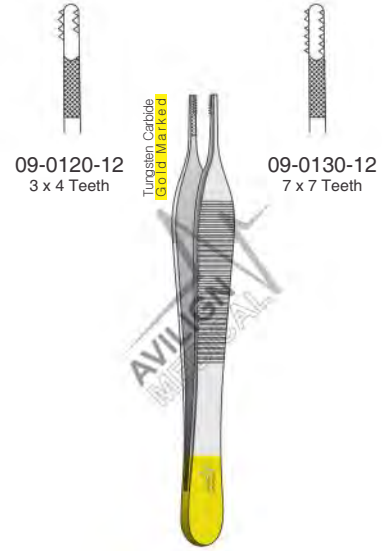

Adson-Brown
12 cm / 4¾"

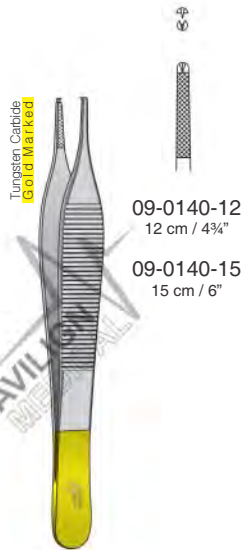

Adson
1 x 2 Teeth



Adson-Micro
Delicate
1 x 2 Teeth

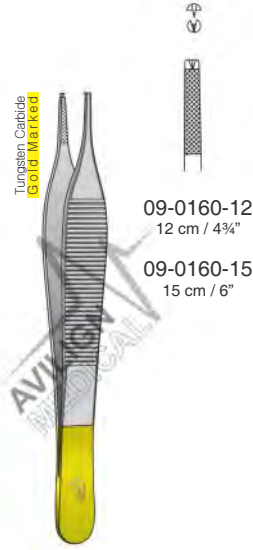

Adson
1 x 2 Teeth

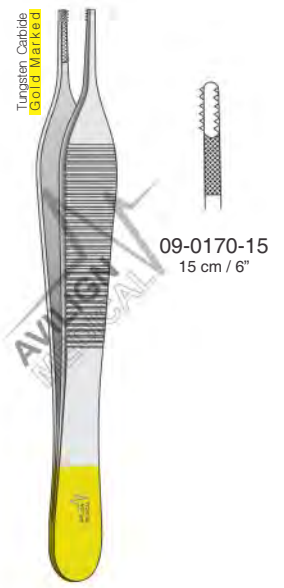

Adson-Brown
7 x 7 Teeth

Chirurgische Pinzetten mit Hartmetalleinsätzen
 Pinzas quirúrgicas con bocas de carburo tungsteno
 Pinze per chirurgia con morsi in carburo di tungsteno
 Tungsten Carbide Tissue Forceps

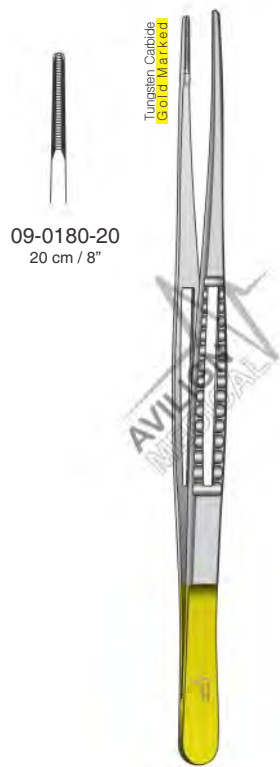

Suture Forceps

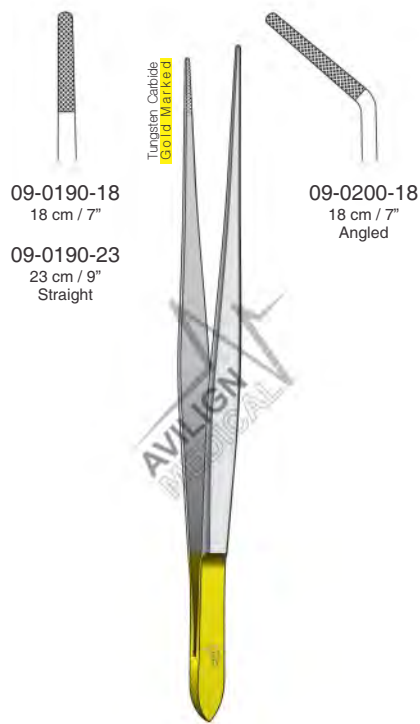

Cushing
Dissector End

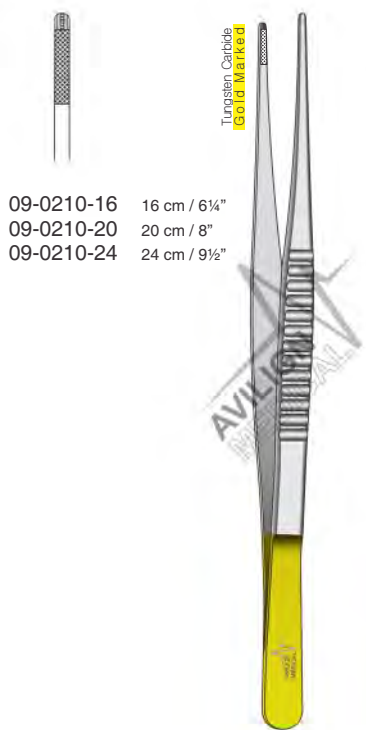

De Bakley
2 mm Tip

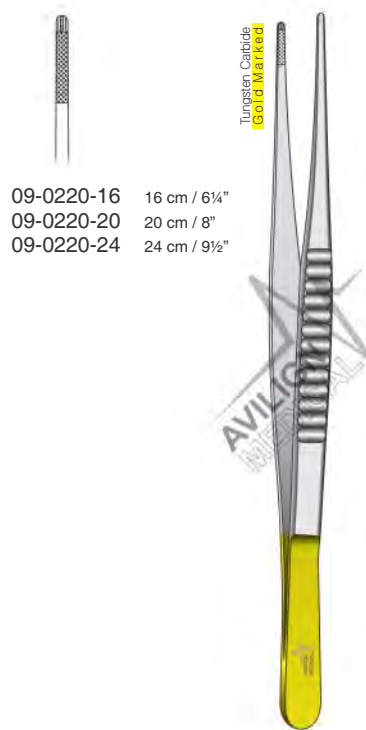

De Bakley
1.5 mm Tip



09-0230-15
15 cm / 6"

Gillies
1 x 2 Teeth

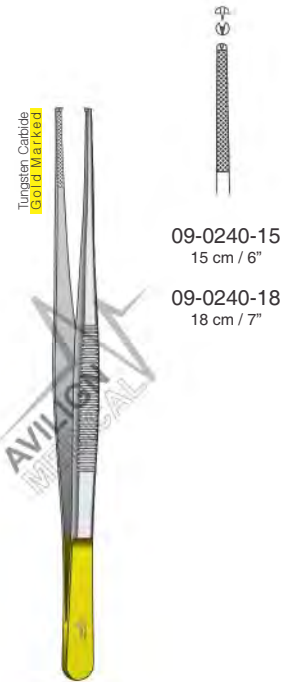

09-0240-15
15 cm / 6"

09-0240-18
18 cm / 7"

Semken
1 x 2 Teeth

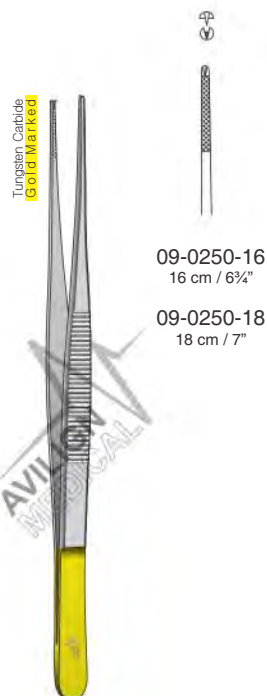

09-0250-16
16 cm / 6 1/4"

09-0250-18
18 cm / 7"

Semken
1 x 2 Teeth
Delicate

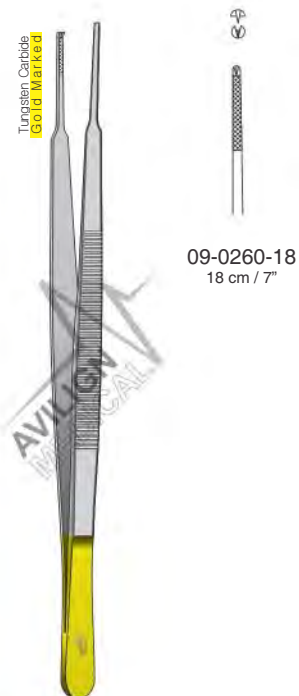

09-0260-18
18 cm / 7"

Gerald
1 x 2 Teeth



10

Artery Forceps

Arterienklemmen
Pinzas Haemostaticas
Pinze emostatiche



10-0010-14
14 cm / 5½"



10-0010-16
16 cm / 6¼"



10-0010-18
18 cm / 7"



10-0010-20
20 cm / 8"

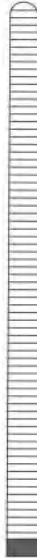

10-0010-22
22 cm / 8¾"



10-0010-24
24 cm / 9½"



10-0010-26
26 cm / 10¼"



Pean
Straight

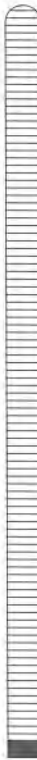

10-0010-28
28 cm / 11"



10-0010-30
30 cm / 11¾"

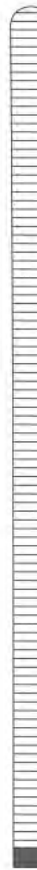

10-0010-36
36 cm / 14¼"

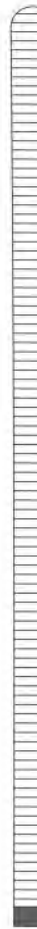

10-0010-40
40 cm / 16"

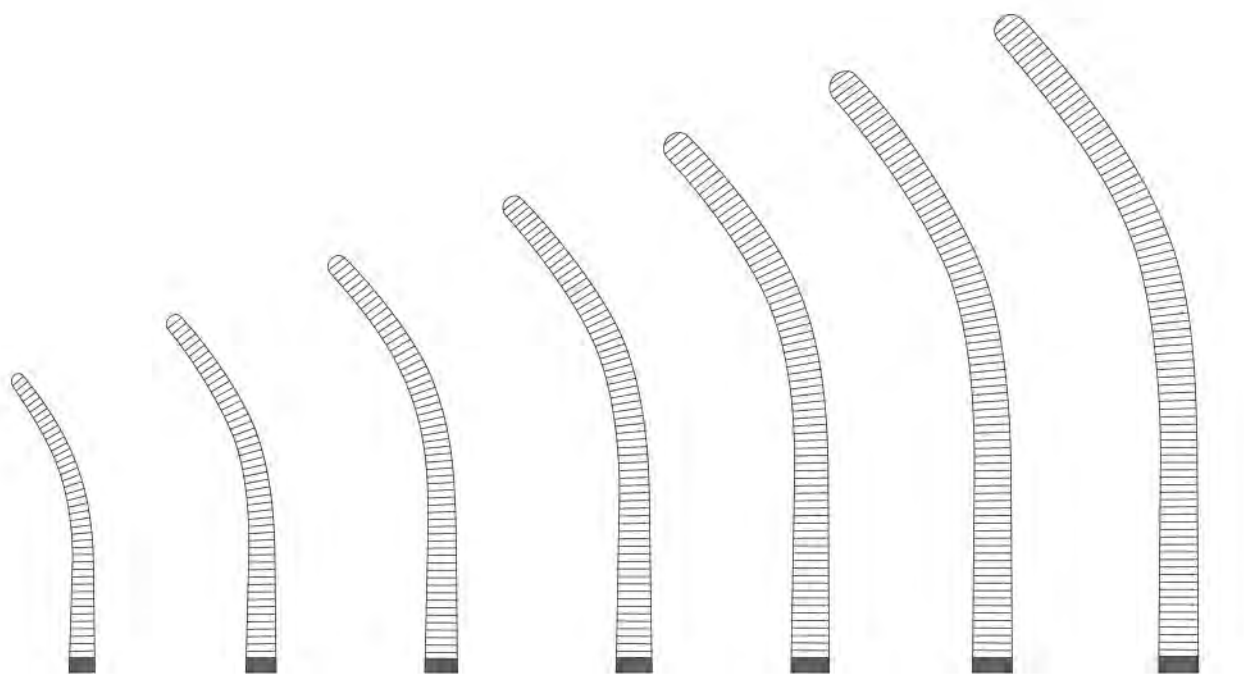

10-0020-14
 14 cm / 5½"

10-0020-16
 16 cm / 6¼"

10-0020-18
 18 cm / 7"

10-0020-20
 20 cm / 8"

10-0020-22
 22 cm / 8¾"

10-0020-24
 24 cm / 9½"

10-0020-26
 26 cm / 10¼"



Pean
 Curved

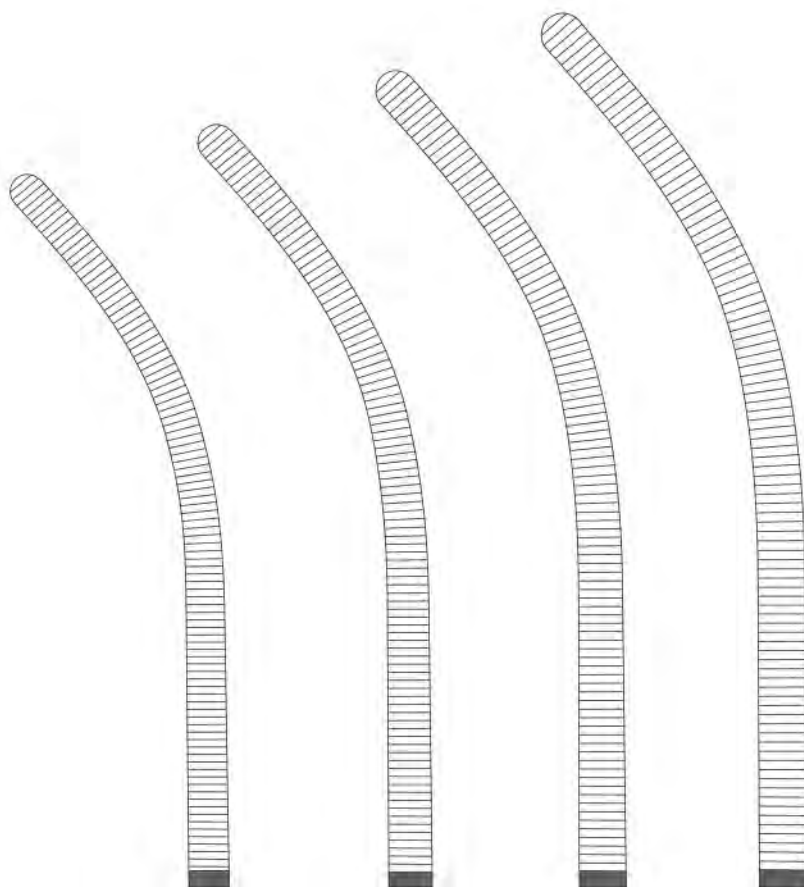

10-0020-28
 28 cm / 11"

10-0020-30
 30 cm / 11¾"

10-0020-36
 36 cm / 14¼"

10-0020-40
 40 cm / 16"

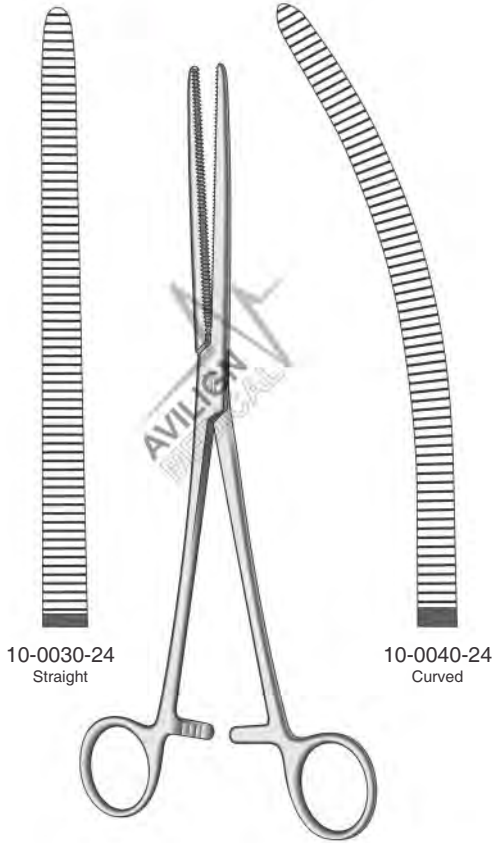

10-0030-24
Straight

10-0040-24
Curved

Pean
24 cm / 9½"

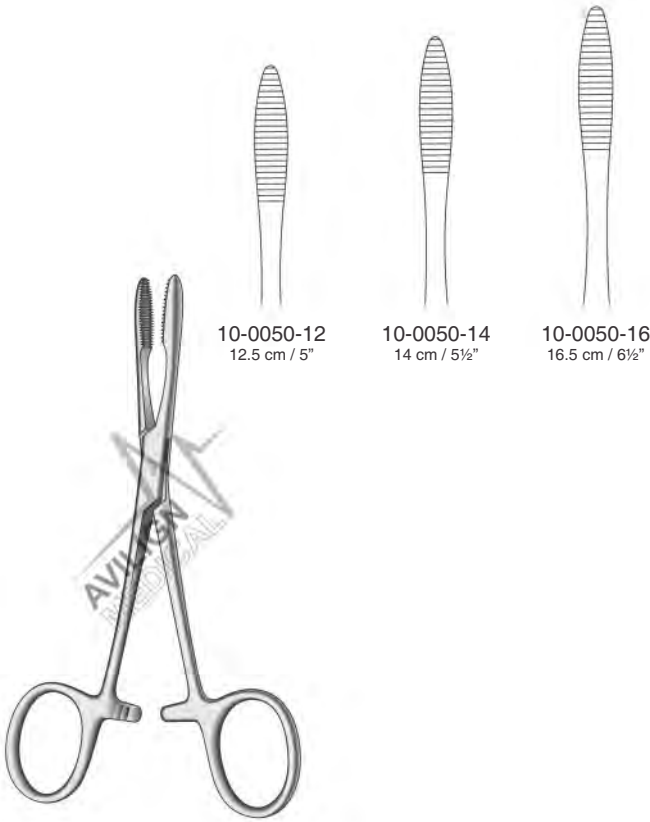

10-0050-12
12.5 cm / 5"

10-0050-14
14 cm / 5½"

10-0050-16
16.5 cm / 6½"

Pean

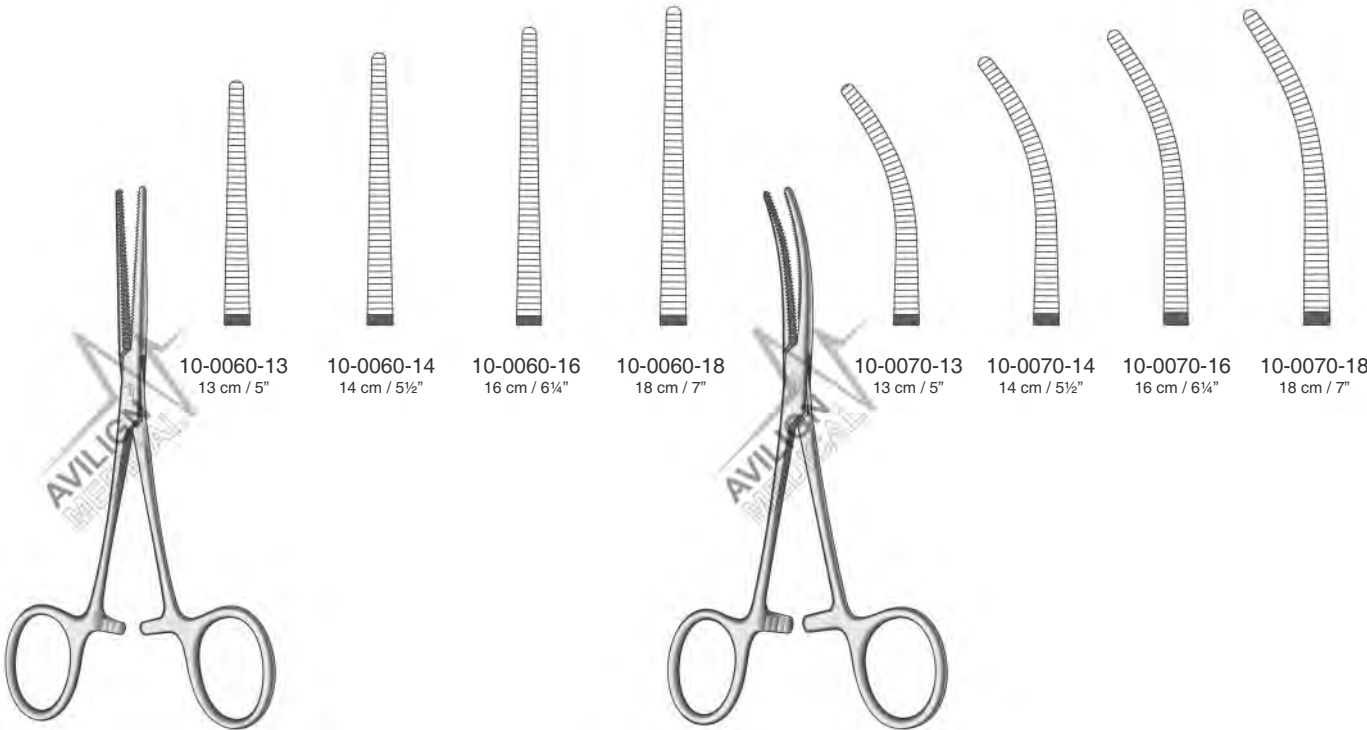

10-0060-13
13 cm / 5"

10-0060-14
14 cm / 5½"

10-0060-16
16 cm / 6¼"

10-0060-18
18 cm / 7"

10-0070-13
13 cm / 5"

10-0070-14
14 cm / 5½"

10-0070-16
16 cm / 6¼"

10-0070-18
18 cm / 7"

Pean
Delicate
Straight

Pean
Delicate
Curved



10-0080-13
 13 cm / 5"



10-0080-14
 14 cm / 5½"



10-0080-15
 15 cm / 6"



10-0080-18
 18 cm / 7"



10-0080-20
 20 cm / 8"



Spencer-Wells
 Straight



10-0090-13
 13 cm / 5"



10-0090-14
 14 cm / 5½"



10-0090-15
 15 cm / 6"



10-0090-18
 18 cm / 7"



10-0090-20
 20 cm / 8"



10-0090-23
 23 cm / 9"



Spencer-Wells
 Curved

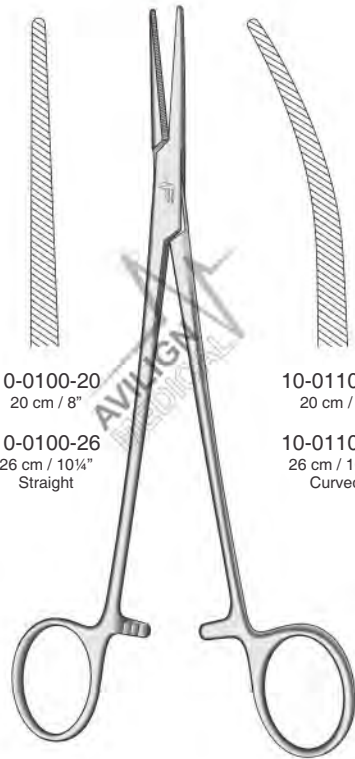

10-0100-20
20 cm / 8"

10-0100-26
26 cm / 10 1/4"
Straight

10-0110-20
20 cm / 8"

10-0110-26
26 cm / 10 1/4"
Curved

Bengolea

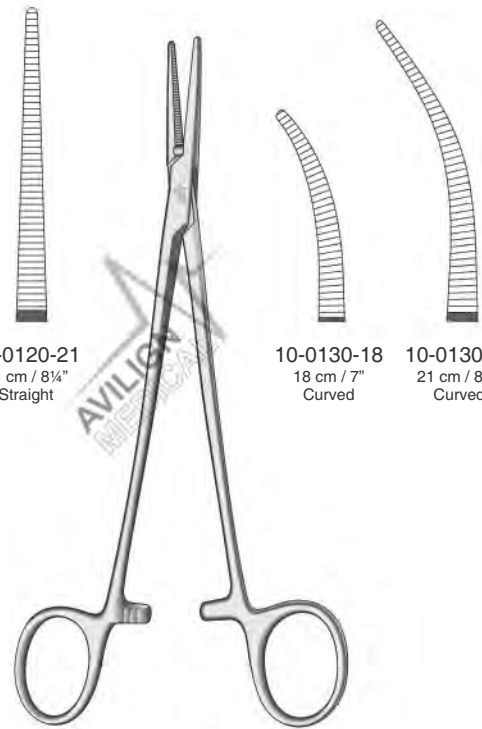

10-0120-18
18 cm / 7"
Straight

10-0120-21
21 cm / 8 1/4"
Straight

10-0130-18
18 cm / 7"
Curved

10-0130-21
21 cm / 8 1/4"
Curved

Halsted-Masquito

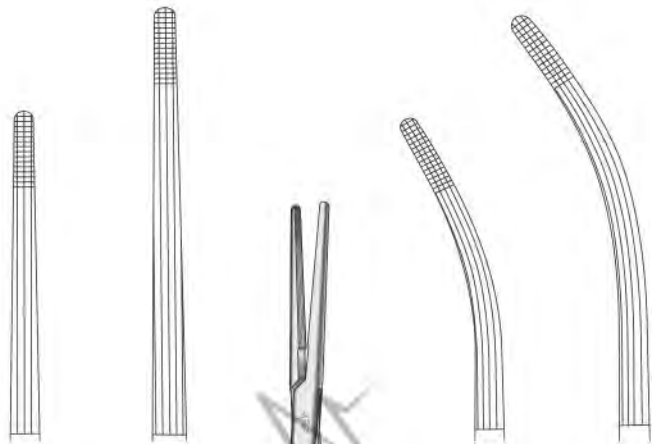

10-0140-16
16 cm / 6 1/4"
Straight

10-0140-20
20 cm / 8"
Straight

10-0150-16
16 cm / 6 1/4"
Curved

10-0150-20
20 cm / 8"
Curved

Rochester-Carmalt

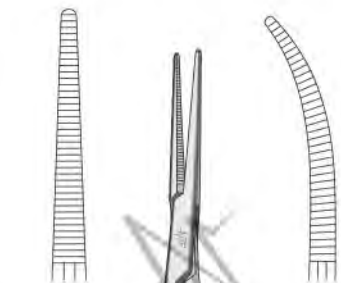

10-0160-16
Straight

10-0170-16
Curved

Crile-Rankin
16 cm / 6 1/4"

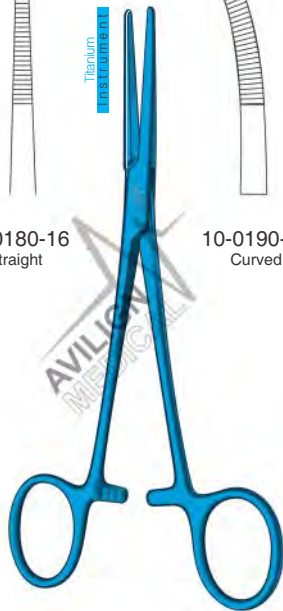
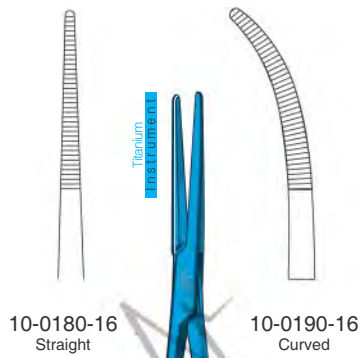

Kelly-Rankin
 16 cm / 6¼"

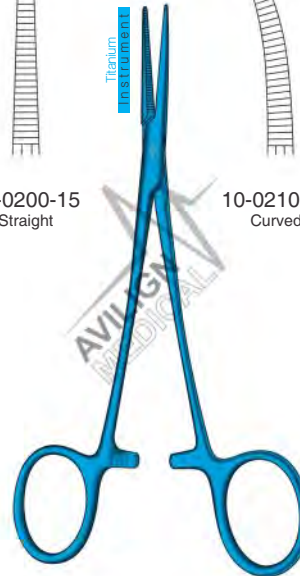
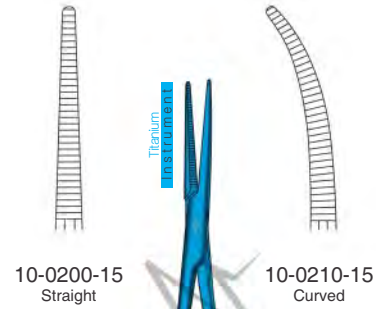

Leriche
 15 cm / 6"

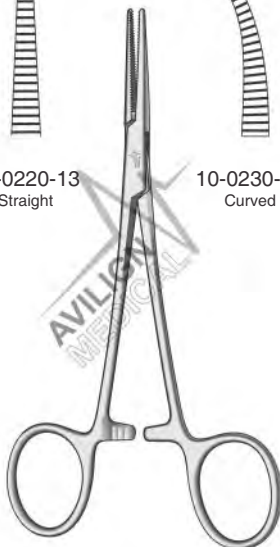
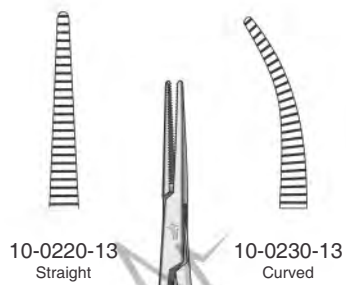

Baby-Crile
 14 cm / 5½"

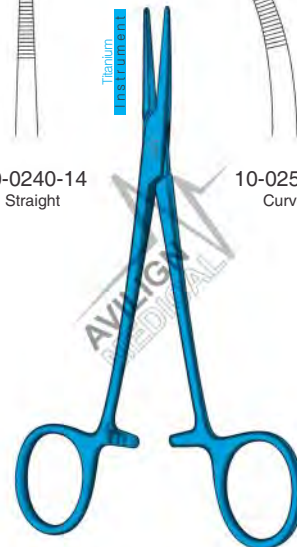
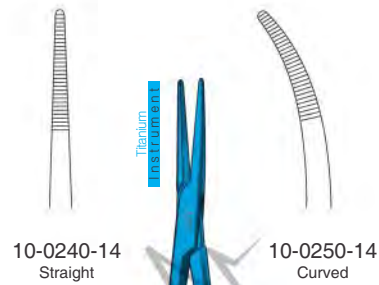

Kelly
 14 cm / 5½"

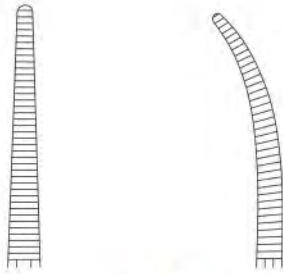

10-0260-14
Straight

10-0270-14
Curved



Crile
14 cm / 5½"



10-0280-12
12.5 cm / 5"
Straight



10-0280-14
14 cm / 5½"
Straight



Halsted-Mosquito



10-0290-12
12.5 cm / 5"
Curved



10-0290-14
14 cm / 5½"
Curved

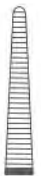

10-0300-12
Straight



10-0310-12
Curved



Halsted-Mosquito
12.5 cm / 5"

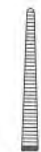

10-0320-10
10 cm / 4"
Straight



10-0320-12
12.5 cm / 5"
Straight

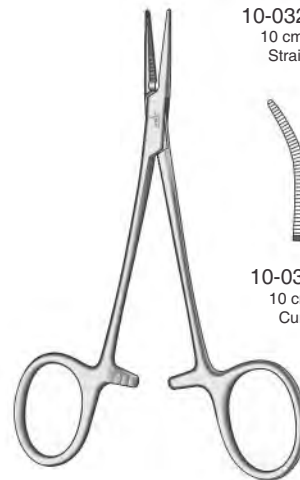

Micro-Mosquito



10-0330-10
10 cm / 4"
Curved



10-0330-12
12.5 cm / 5"
Curved

Arterienklemmen
 Pinzas hemostáticas
 Pinze emostatiche
 Haemostatic Forceps



10-0340-14
 14 cm / 5½"



10-0340-15
 15 cm / 6"



10-0340-16
 16 cm / 6¼"



10-0340-18
 18 cm / 7"



10-0340-20
 20 cm / 8"

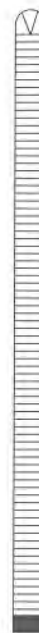

10-0340-22
 22 cm / 8¾"



10-0340-24
 24 cm / 9½"



10-0340-26
 26 cm / 10¼"



10-0340-30
 30 cm / 11¾"



10-0340-36
 36 cm / 14¼"



10-0340-40
 40 cm / 16"



Ochsner-Kocher
 Straight
 1 x 2 Teeth

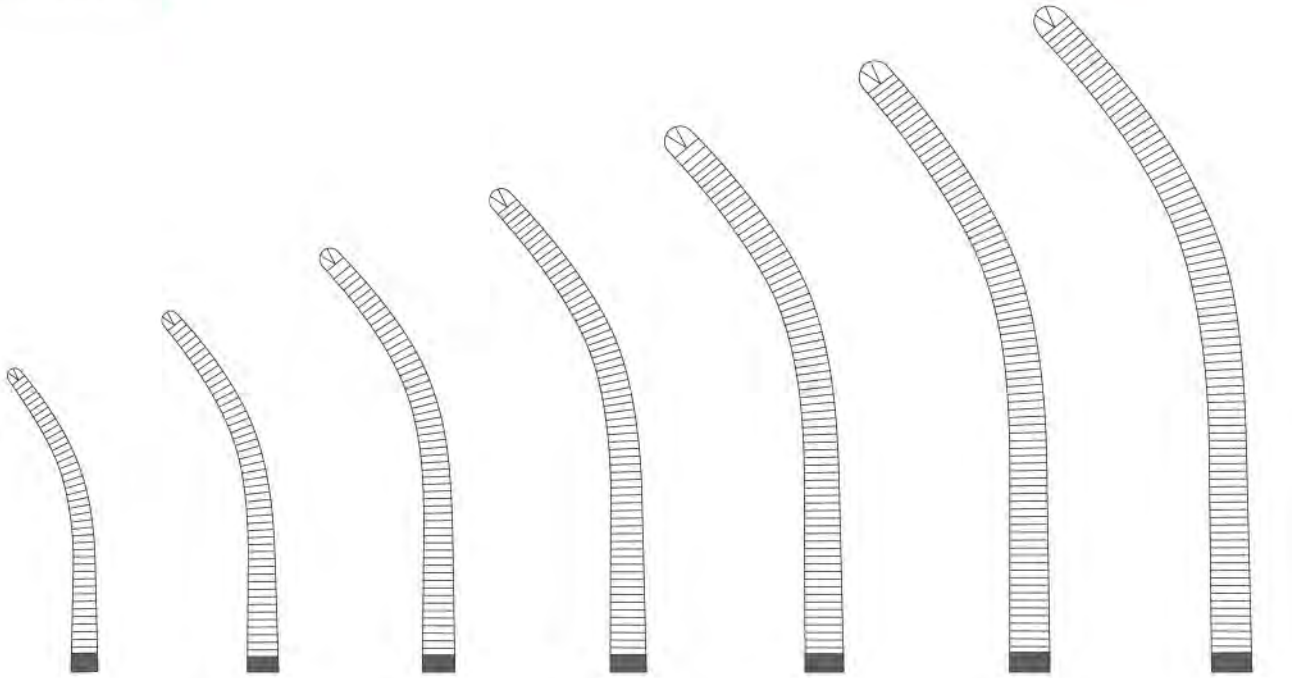

10-0350-14
14 cm / 5½"

10-0350-15
15 cm / 6"

10-0350-16
16 cm / 6¼"

10-0350-18
18 cm / 7"

10-0350-20
20 cm / 8"

10-0350-22
22 cm / 8¾"

10-0350-24
24 cm / 9½"

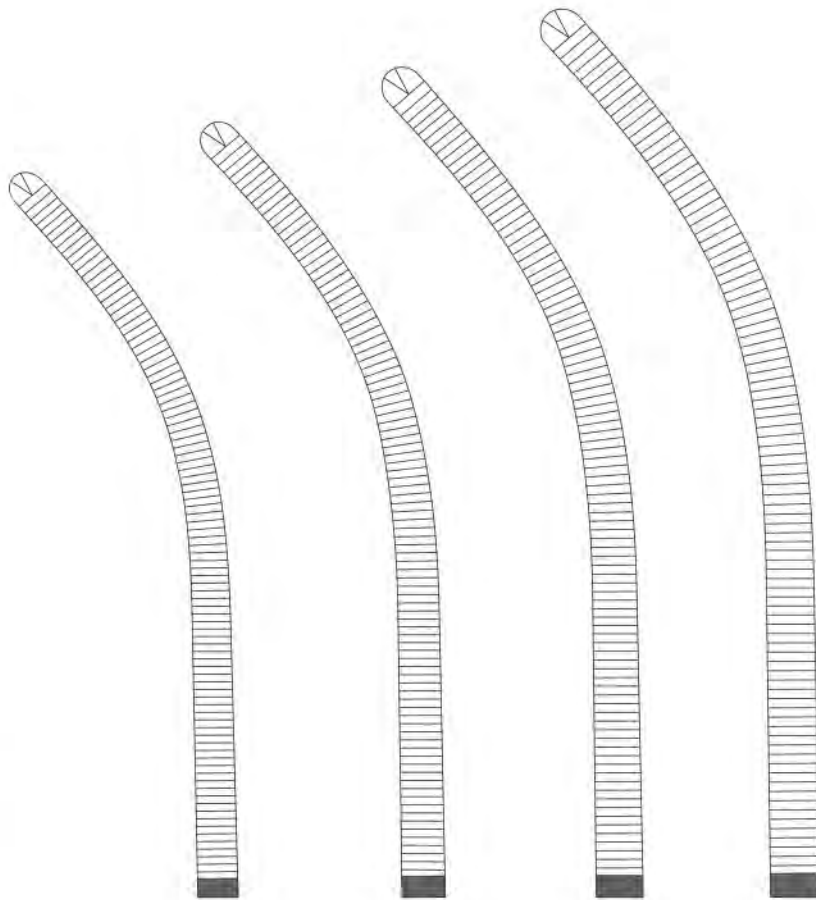

10-0350-26
26 cm / 10¼"

10-0350-30
30 cm / 11¾"

10-0350-36
36 cm / 14¼"

10-0350-40
40 cm / 16"



Ochsner-Kocher
Curved

Arterienklemmen
 Pinzas hemostáticas
 Pinze emostatiche
 Haemostatic Forceps



10-0360-13
13 cm / 5"



10-0360-14
14 cm / 5½"



10-0370-13
13 cm / 5"



10-0370-14
14 cm / 5½"



10-0360-16
16 cm / 6¼"



10-0360-18
18 cm / 7"



10-0370-16
16 cm / 6¼"



10-0370-18
18 cm / 7"



Kocher
Delicate, Straight
1 x 2 Teeth



Kocher
Delicate, Curved
1 x 2 Teeth



10-0380-10
Straight



10-0390-10
Curved



Hartmann
10 cm / 4"



10-0400-12
12 cm / 4¾"



Baby-Mosquito



10-0410-14
14 cm / 5½"



Kocher
1 x 2 Teeth

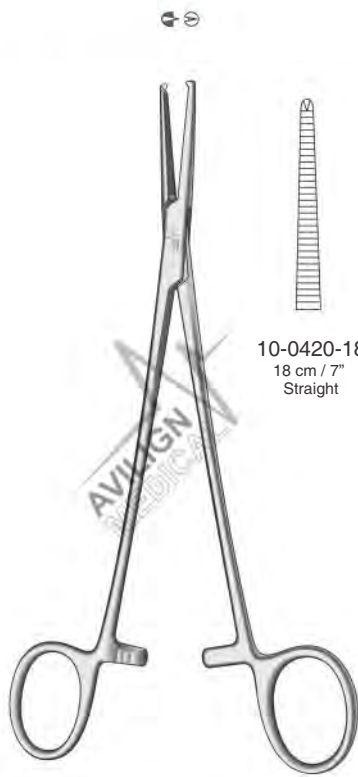

Halsted-Mosquito
1 x 2 Teeth

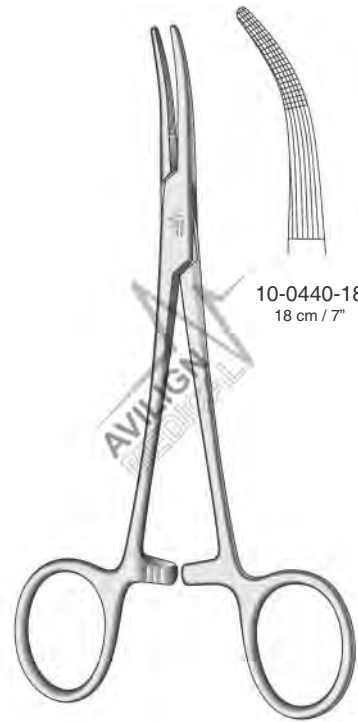
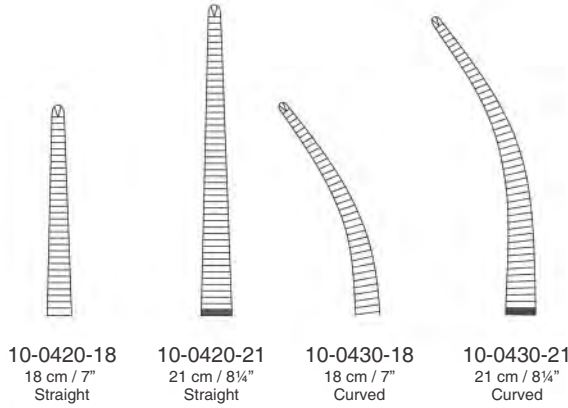

Grey-Turner

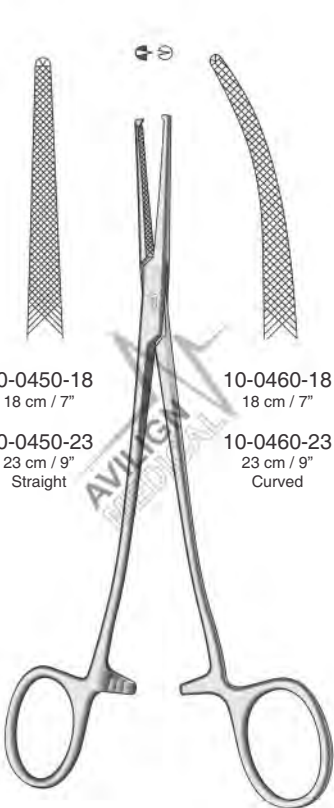

Bengolea (MOD. French)
1 x 2 Teeth

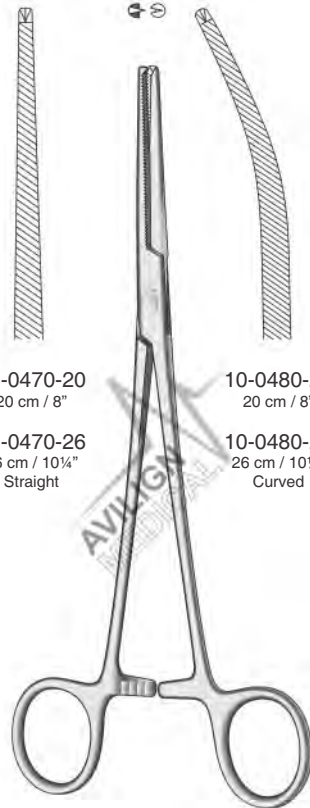
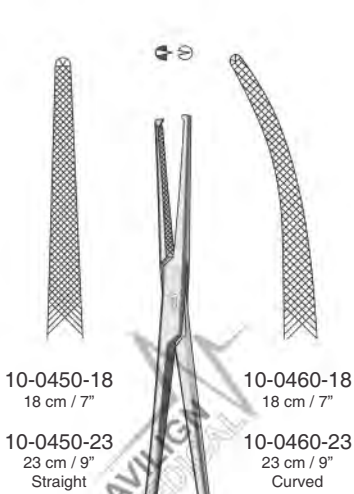

Bengolea
1 x 2 Teeth

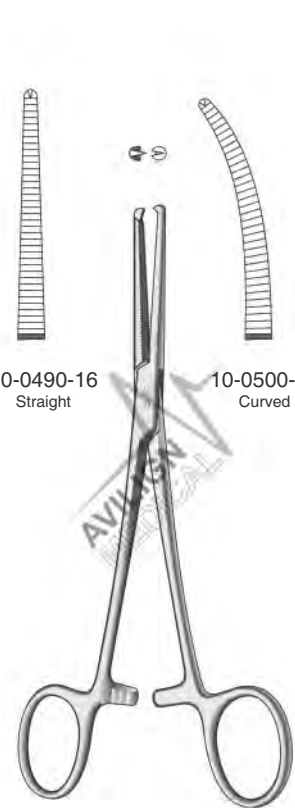
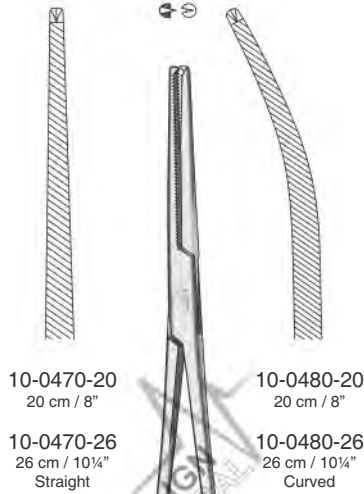

Crile-Rankin
16 cm / 6¼"
1 x 2 Teeth

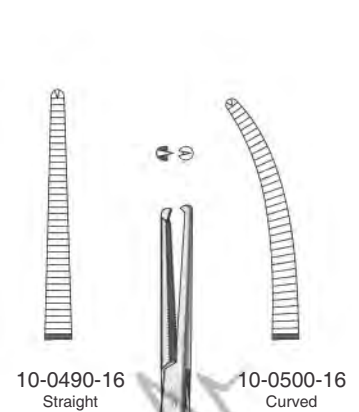

Arterienklemmen
 Pinzas hemostáticas
 Pinze emostatiche
 Haemostatic Forceps

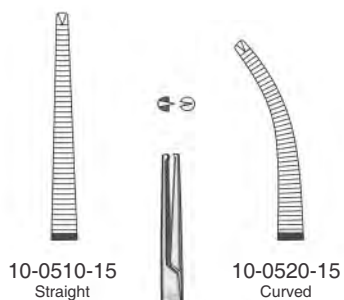

Leriche
 15 cm / 6"
 1 x 2 Teeth

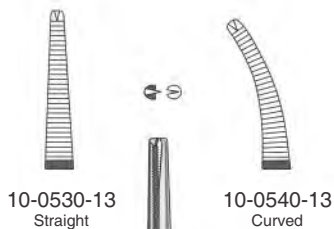

Baby-Crile
 14 cm / 5½"
 1 x 2 Teeth

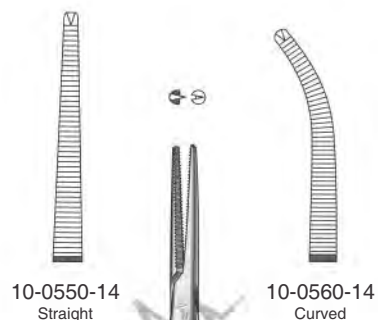

Crile
 14 cm / 5½"
 1 x 2 Teeth

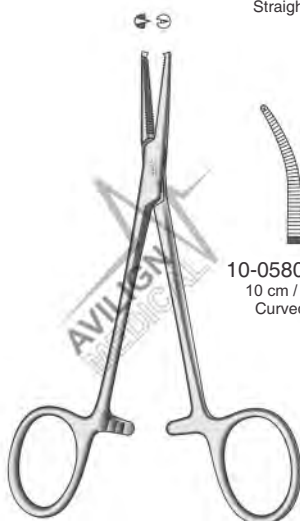
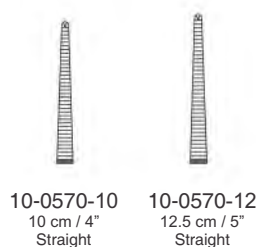

Micro-Mosquito
 1 x 2 Teeth

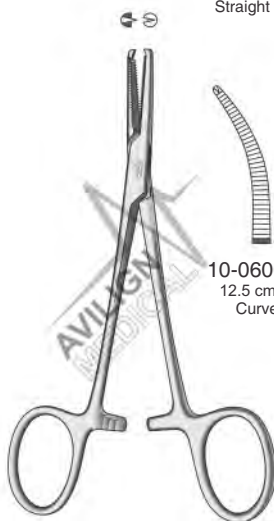
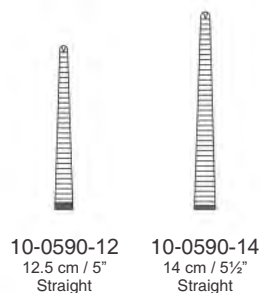

Halsted-Mosquito
 1 x 2 Teeth

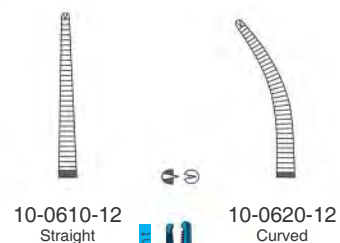
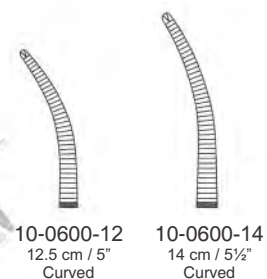
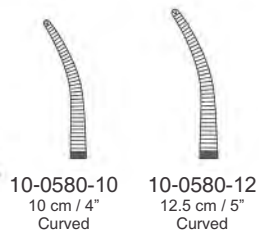

Halsted-Mosquito
 12.5 cm / 5"
 1 x 2 Teeth

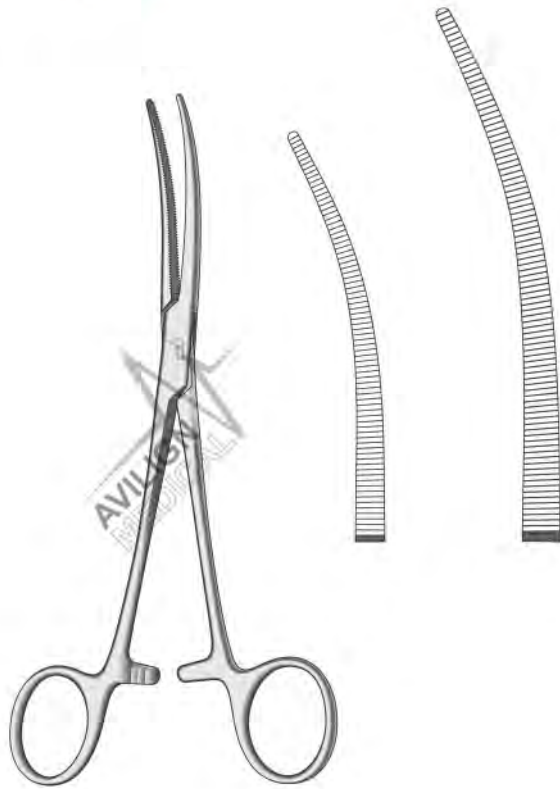

Craford
Curved

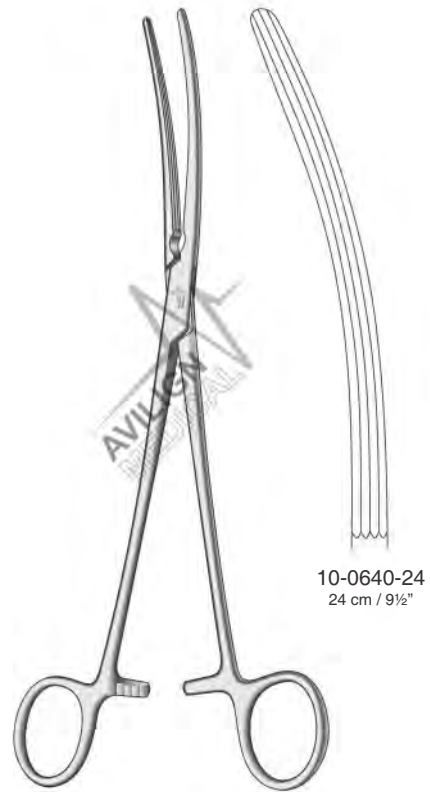

Craford-Sellors
Curved

10-0640-24
24 cm / 9½"



Sarot

10-0650-24
24 cm / 9½"
Straight

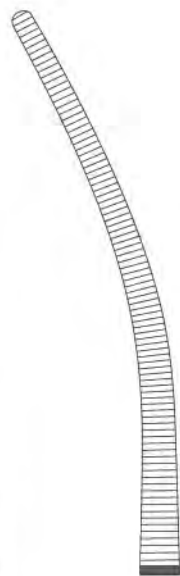

10-0660-24
24 cm / 9½"
Curved



10-0670-24
24 cm / 9½"
1 x 2 Teeth

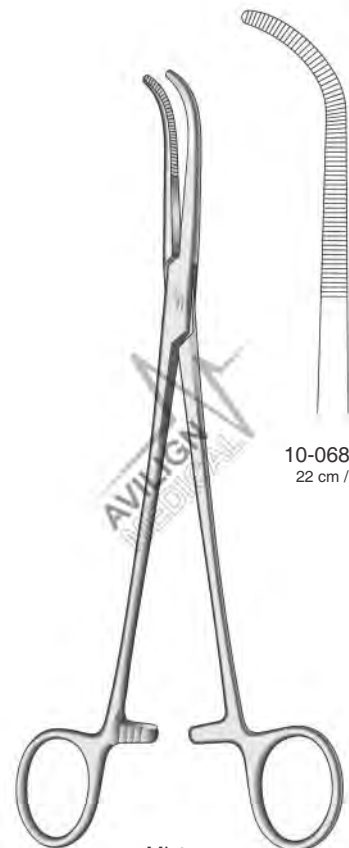

Mixer

10-0680-22
22 cm / 8¾"

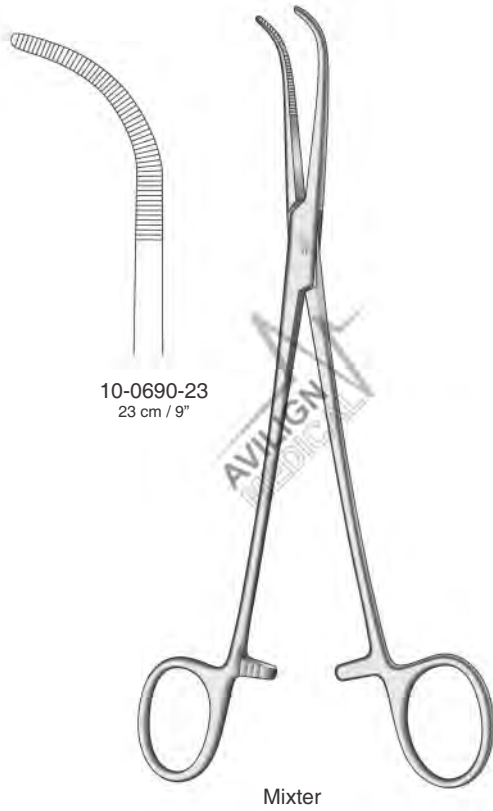

10-0690-23
 23 cm / 9"

Mixer

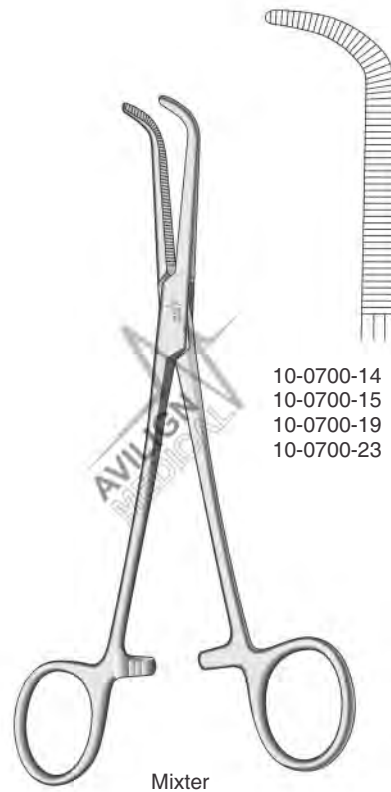

10-0700-14 14 cm / 5½"
 10-0700-15 15 cm / 6"
 10-0700-19 19 cm / 7½"
 10-0700-23 23 cm / 9"

Mixer



10-0710-19 19 cm / 7½"
 10-0710-22 22 cm / 8¾"
 10-0710-24 24 cm / 9½"



10-0720-19 19 cm / 7½"
 10-0720-22 22 cm / 8¾"
 10-0720-24 24 cm / 9½"



10-0730-19 19 cm / 7½"
 10-0730-22 22 cm / 8¾"
 10-0730-24 24 cm / 9½"



Kelly

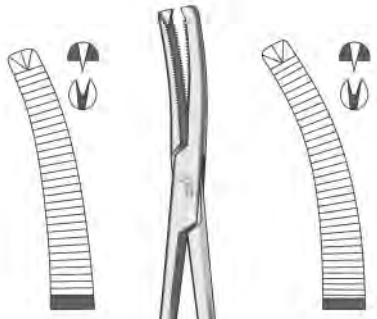

10-0740-22
22 cm / 8¾"

10-0740-23
23 cm / 9"

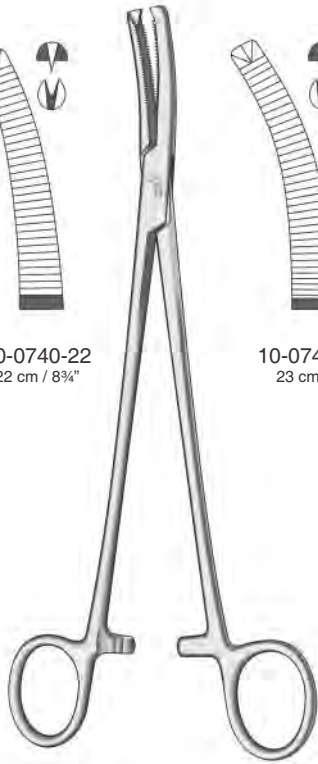

Wertheim

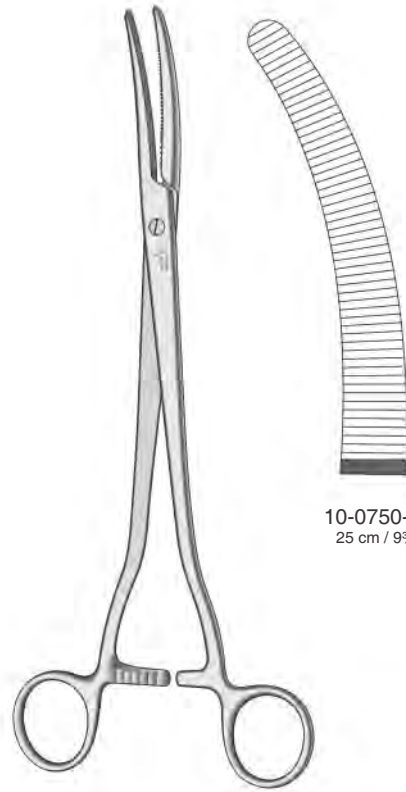

Faure

10-0750-25
25 cm / 9¾"

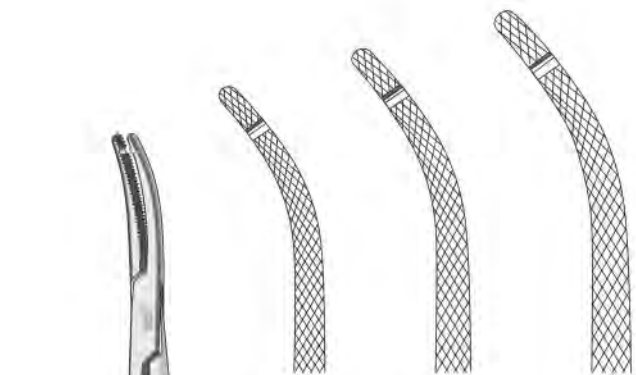

10-0760-20
20 cm / 8"

10-0760-21
21 cm / 8¼"

10-0760-23
23 cm / 9"



Heany

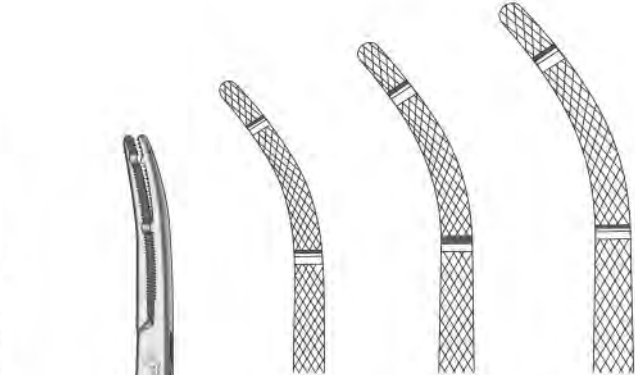

10-0770-20
20 cm / 8"

10-0770-21
21 cm / 8¼"

10-0770-23
23 cm / 9"



Heany

Peritoneumklemmen
 Pinzas para peritoneo
 Pinze per peritoneo
 Peritoneum Forceps



10-0780-18
 18.5 cm / 7¼"



Mikulicz
 1 x 2 Teeth



10-0790-20
 20 cm / 8"



Mikulicz
 1 x 2 Teeth



10-0800-14
 14 cm / 5½"



Baby-Mikulicz
 1 x 2 Teeth



10-0810-19
 19 cm / 7½"

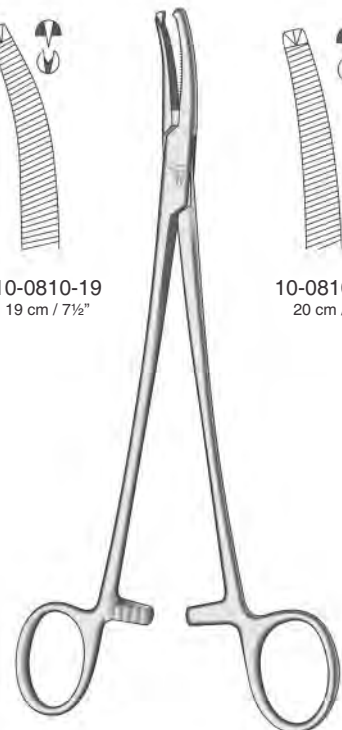

Faure
 1 x 2 Teeth

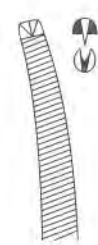

10-0810-20
 20 cm / 8"

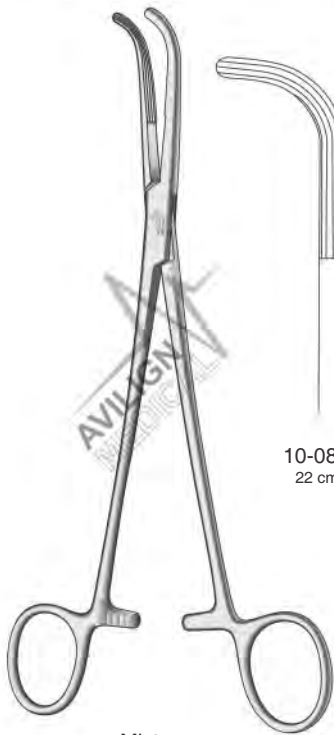

Mixer

10-0820-22
22 cm / 8¾"

10-0820-25
25 cm / 9¾"

10-0820-28
28 cm / 11"



Finochietto

10-0830-24
24 cm / 9½"

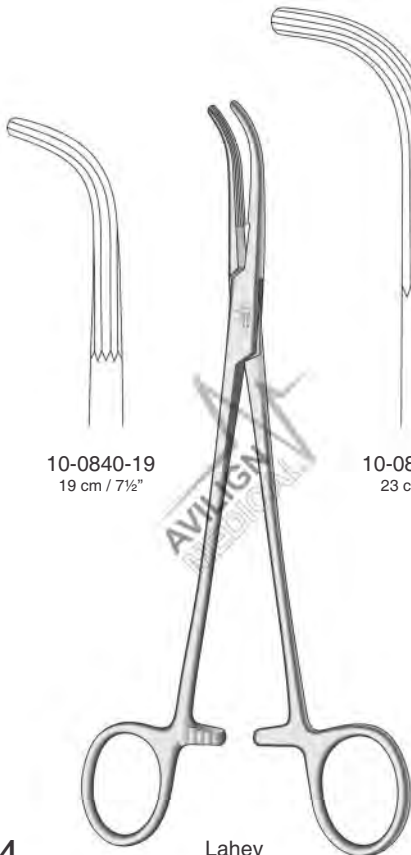

Lahey

10-0840-19
19 cm / 7½"

10-0840-23
23 cm / 9"

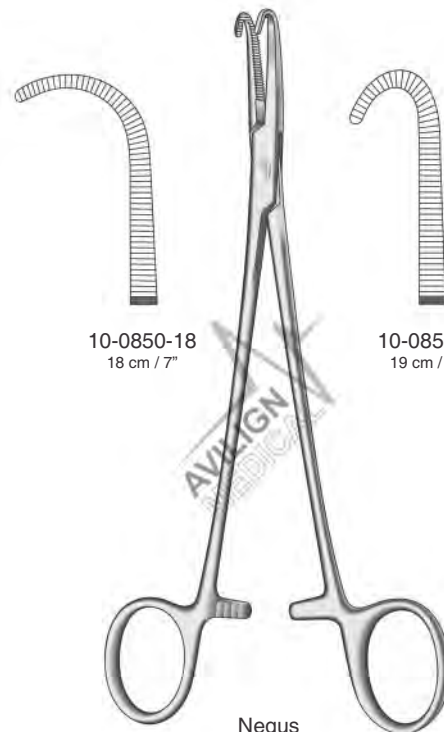

Negus

10-0850-18
18 cm / 7"

10-0850-19
19 cm / 7½"

Nierenstielklemmen
 Pinzas para pedículo renal
 Pinze per peduncoli renali
 Kidney Pedicel Clamps



Guyon

AVILIGN
 Instrument

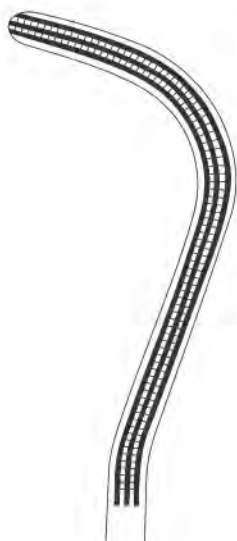

10-0860-23
 23 cm / 9"

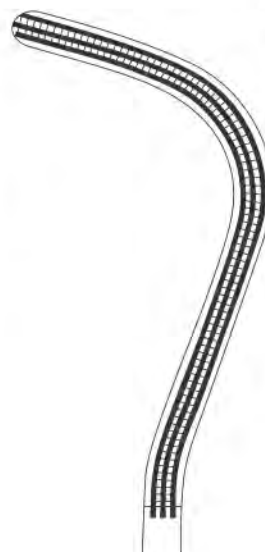

10-0860-24
 24 cm / 9½"



10-0860-25
 25 cm / 9¾"

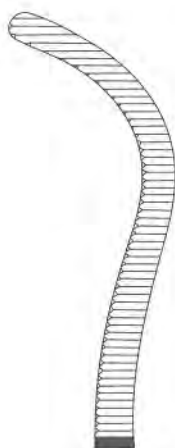

10-0870-20
 20 cm / 8"

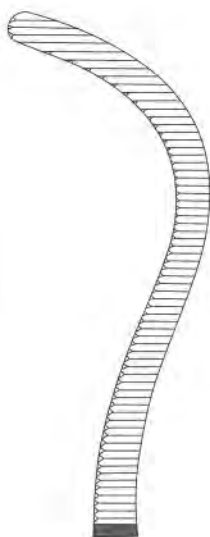

10-0870-22
 22 cm / 8¾"

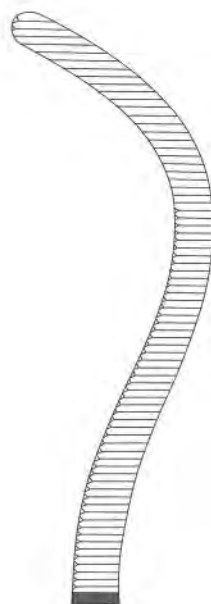

10-0870-24
 24 cm / 9½"

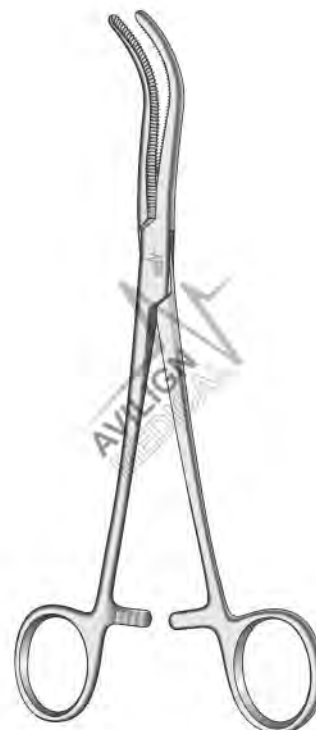

Guyon



10-0880-22 22 cm / 8½"
10-0880-25 25 cm / 9¾"
10-0880-30 30 cm / 11¾"
10-0880-35 35 cm / 13¾"



10-0890-22 22 cm / 8½"
10-0890-25 25 cm / 9¾"
10-0890-30 30 cm / 11¾"
10-0890-35 35 cm / 13¾"

Altrauma
Instrument



Z-Parametrium



10-0900-21 21 cm / 8¼"
10-0900-25 25 cm / 9¾"
10-0900-30 30 cm / 11¾"
10-0900-35 35 cm / 13¾"



10-0910-21 21 cm / 8¼"
10-0910-25 25 cm / 9¾"
10-0910-30 30 cm / 11¾"
10-0910-35 35 cm / 13¾"

Bulldogklemmen
Clamps Bulldog
Clamps Bulldog
Bulldog Clamps

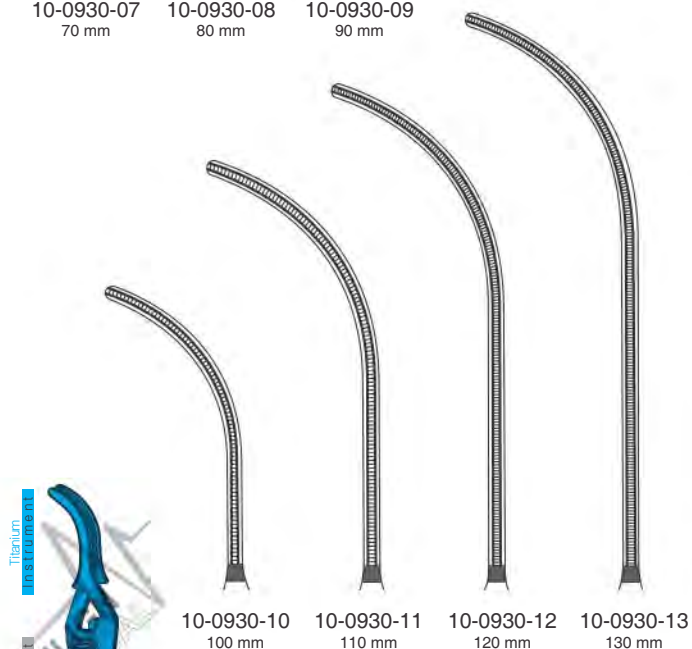
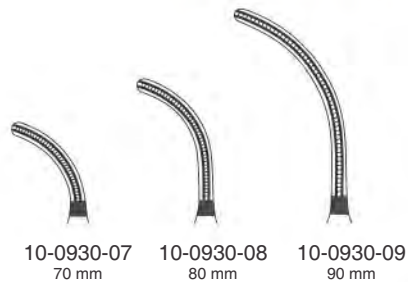
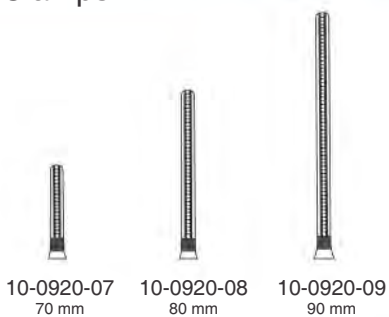

De Bakey
Straight



De Bakey
Curved

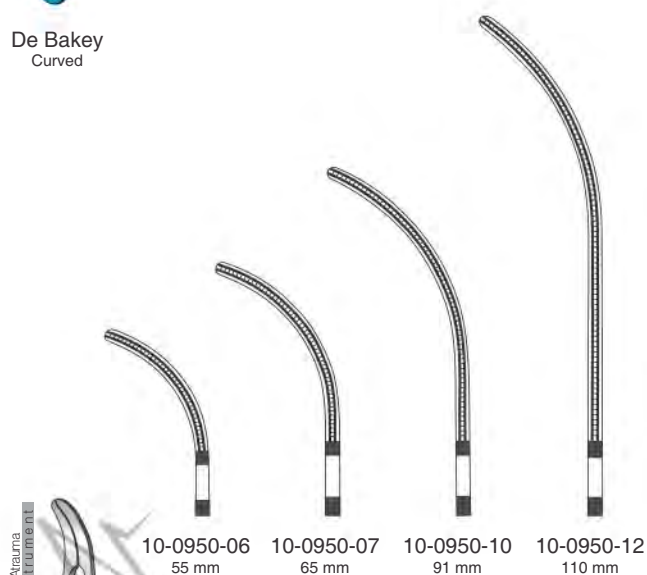
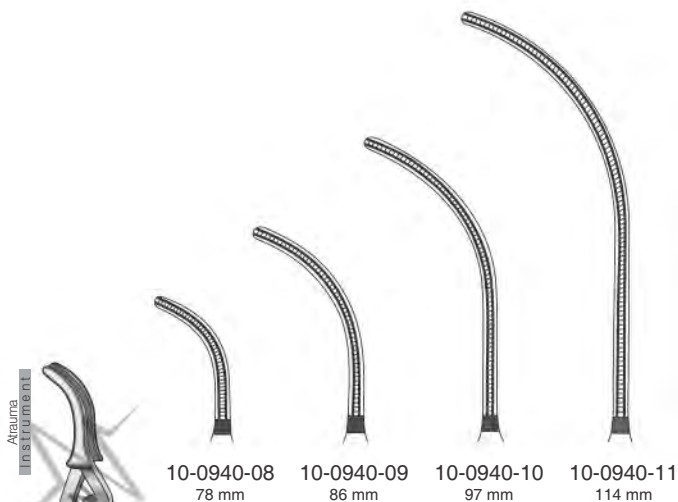

De Bakey



Glover



10-0960-08
8 mm
Straight

10-0960-12
12 mm
Straight

10-0960-20
20 mm
Straight



10-0980-08
8 mm
Straight

10-0980-12
12 mm
Straight

10-0980-20
20 mm
Straight



10-0970-08
8 mm
Angled

10-0970-12
12 mm
Angled

10-0970-20
20 mm
Angled

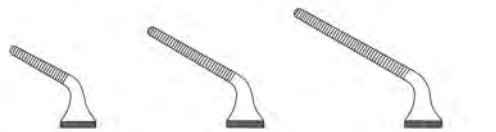

10-0990-08
8 mm
Angled

10-0990-12
12 mm
Angled

10-0990-20
20 mm
Angled



Diethrich



Diethrich

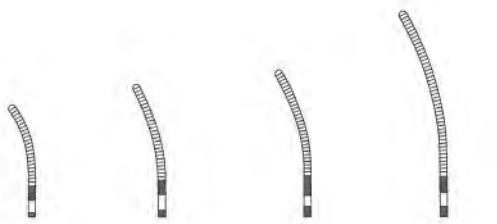

10-1000-30
30 mm

10-1000-35
35 mm

10-1000-40
40 mm

10-1000-50
50 mm

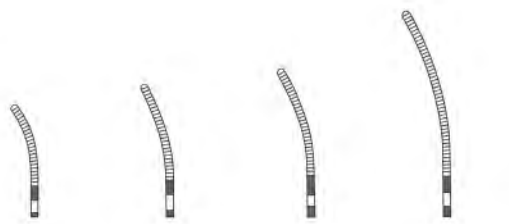

10-1010-30
30 mm

10-1010-35
35 mm

10-1010-40
40 mm

10-1010-50
50 mm



Vena
Curved



Arteria
Curved



10-1020-29 20 mm
10-1020-30 30 mm

Hess

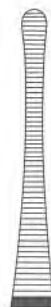

10-1030-63
63 mm



10-1030-80
80 mm

John-Hopkins



10-1040-10
10 mm
Straight



10-1040-14
14 mm
Straight



10-1040-20
20 mm
Straight



10-1060-10
10 mm
Straight



10-1060-14
14 mm
Straight



10-1060-20
20 mm
Straight



10-1050-10
10 mm
Angled



10-1050-14
14 mm
Angled



10-1050-20
20 mm
Angled



10-1070-10
10 mm
Angled



10-1070-14
14 mm
Angled



10-1070-20
20 mm
Angled



De Bakey-Diethrich



De Bakey-Diethrich

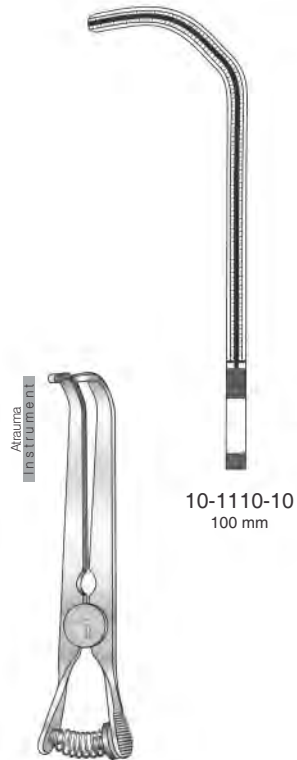
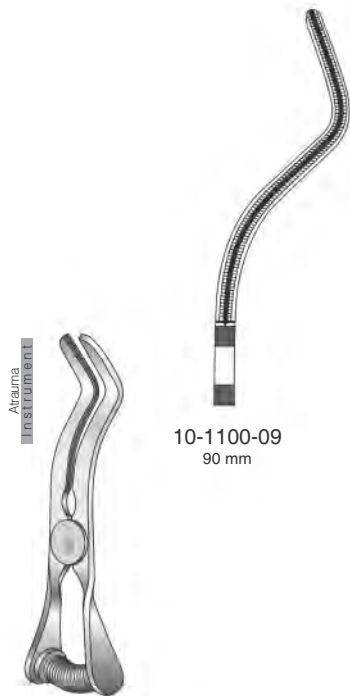
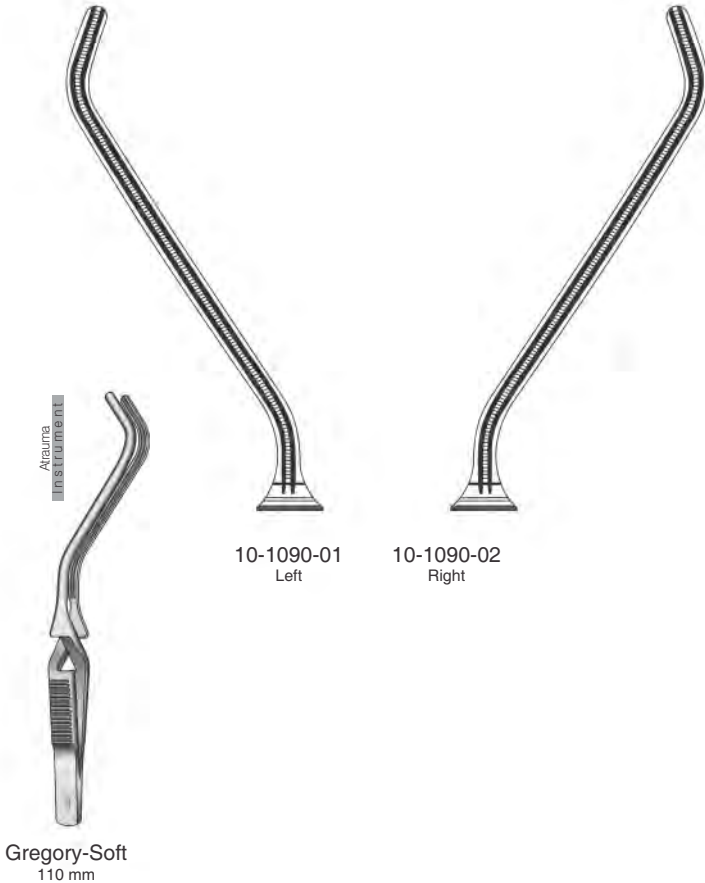
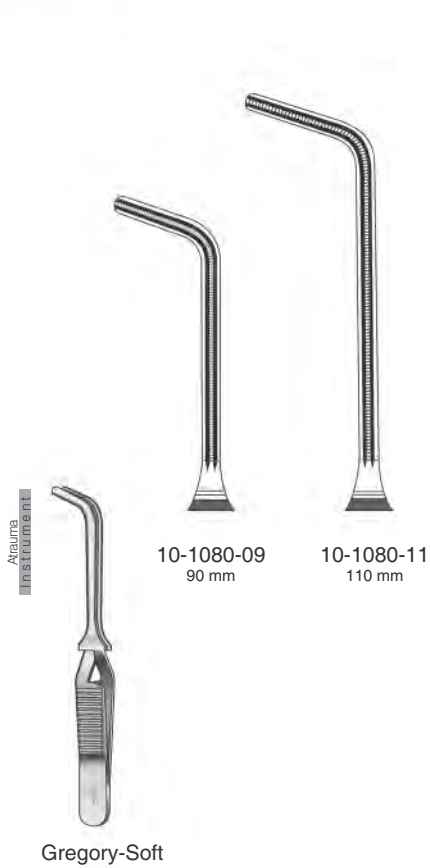

Neonatal-Gefäßklemmen, Atraumatische Gefäßklemmen
 Pinzas vasculares Para recién nacidos, pinzas vasculares atraumáticas
 Pinze vascolari per neonati, pinze vascolari atraumatiche
 Neonatal Vascular Clamps, Atraumatic Vascular Clamps

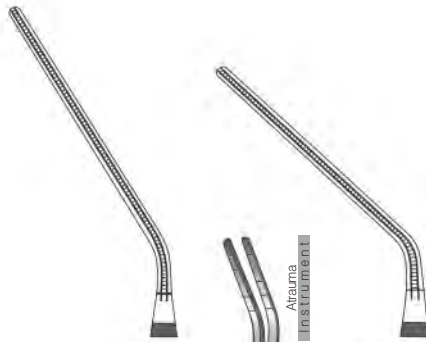

10-1120-11
Angled at 30°

10-1120-12
Angled at 45°



Castaneda
12 cm / 4 3/4"



10-1130-01
11.5 cm / 4 1/2"
Fig. 1

10-1130-02
12 cm / 4 3/4"
Fig. 2

10-1130-03
12 cm / 4 3/4"
Fig. 3

10-1130-04
12 cm / 4 3/4"
Fig. 4



Castaneda

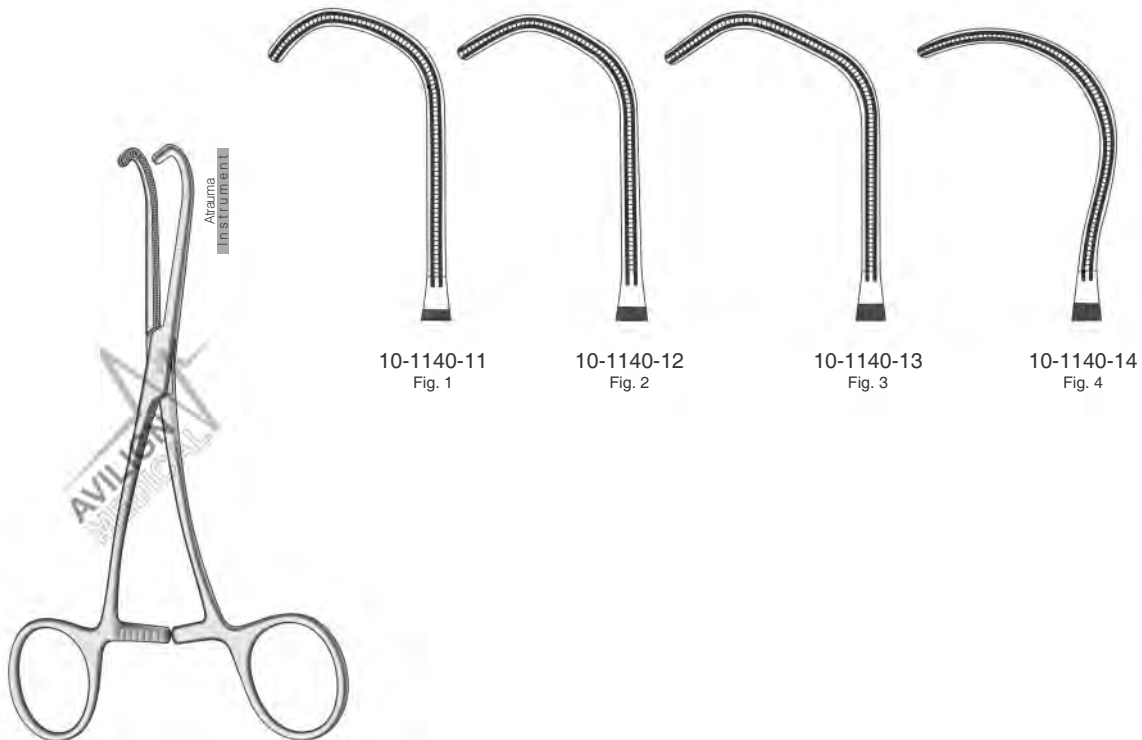

10-1140-11
Fig. 1

10-1140-12
Fig. 2

10-1140-13
Fig. 3

10-1140-14
Fig. 4

Castaneda
15.5 cm / 6"

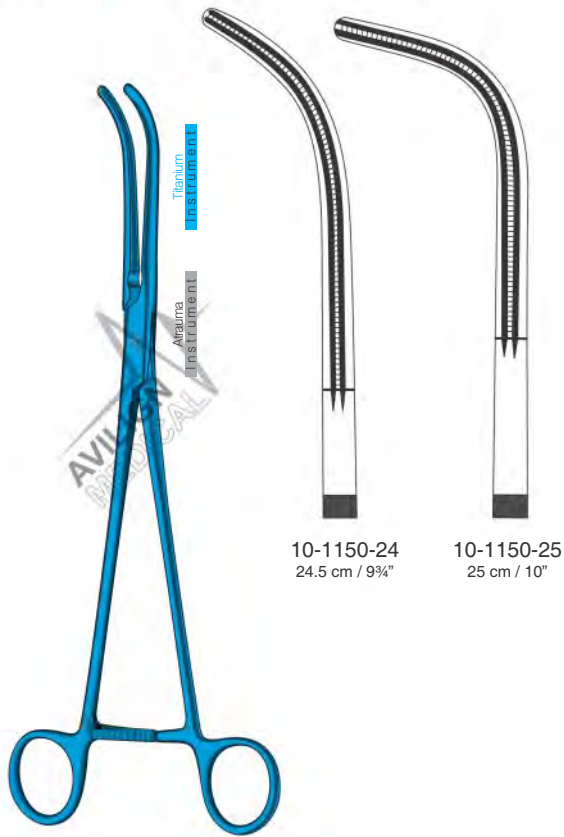

10-1150-24
24.5 cm / 9 3/4"

10-1150-25
25 cm / 10"

De Bakey-Rumel

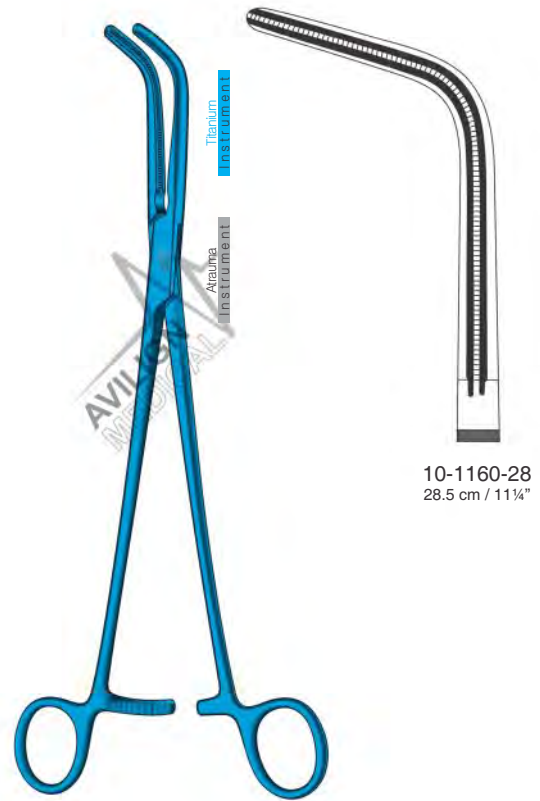

10-1160-28
28.5 cm / 11 1/4"

De Bakey-Mixer

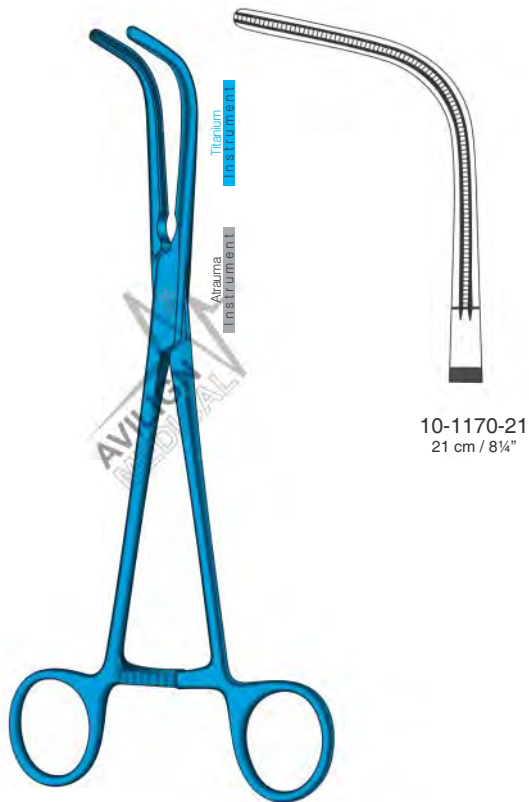

10-1170-21
21 cm / 8 1/4"

MC Quigg-Mixer

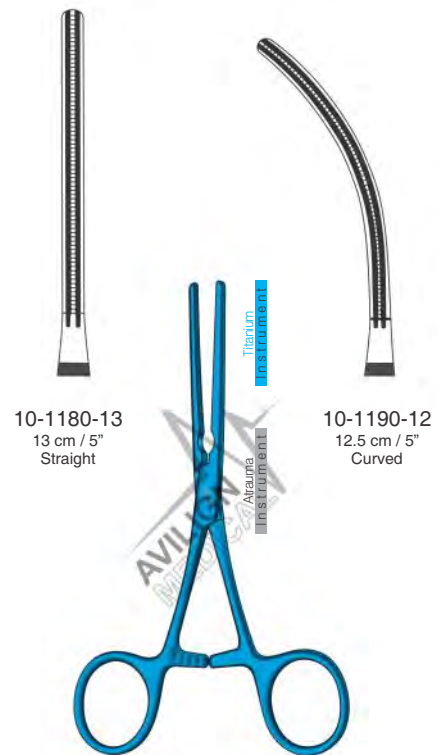

10-1180-13
13 cm / 5"
Straight

10-1190-12
12.5 cm / 5"
Curved

De Bakey

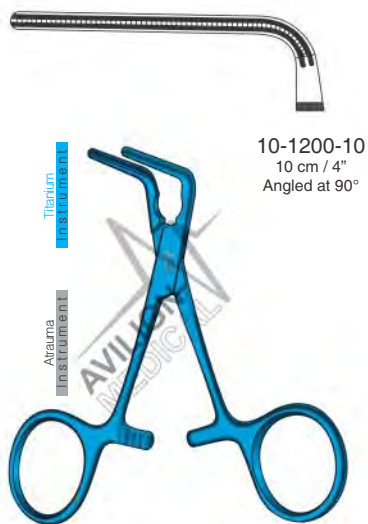

De Bakey

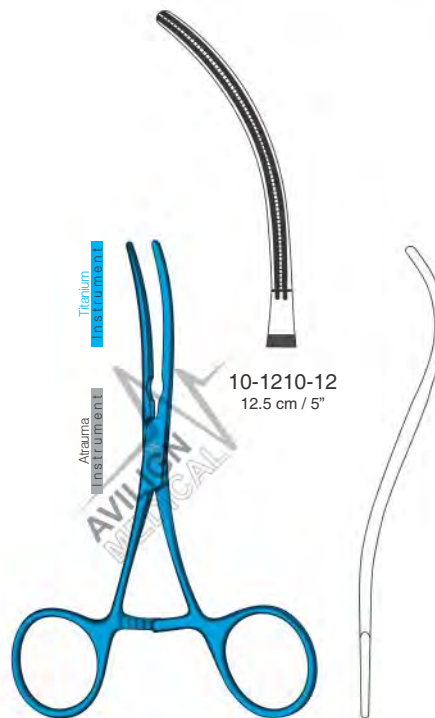

De Bakey
 S-Shaped

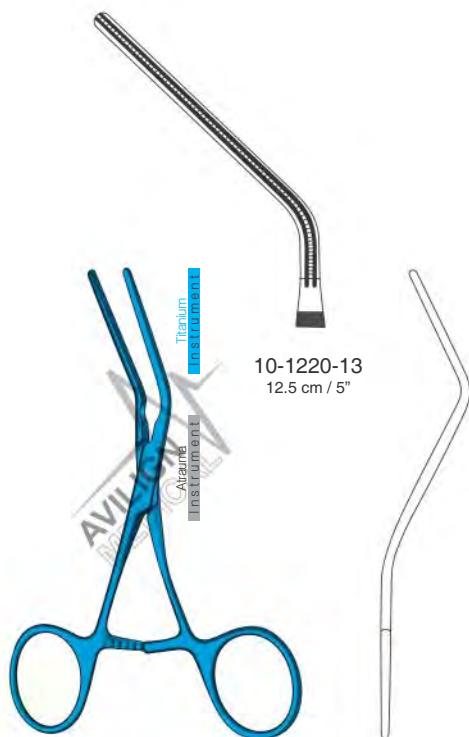

De Bakey

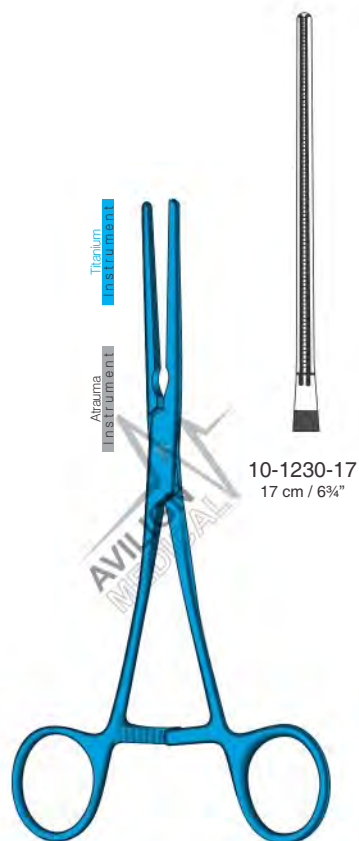

De Bakey



10-1240-12
12.5 cm / 5"
Straight



10-1250-12
12.5 cm / 5"
Curved

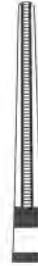

10-1260-16
Straight



10-1270-16
Curved



10-1240-15
15.5 cm / 6"
Straight



10-1250-15
15.5 cm / 6"
Curved

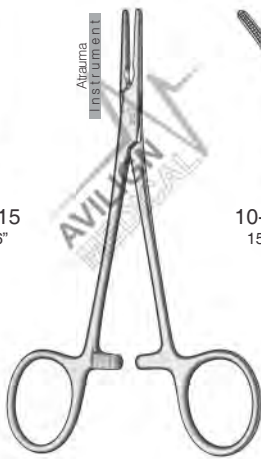

De Bakey-Mosquito

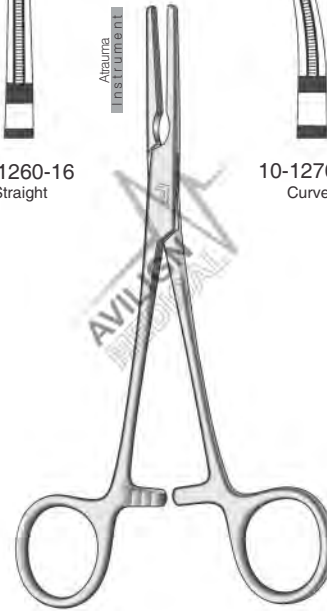

De Bakey-Rankin
16 cm / 6¼"

Atrauma
Instrument

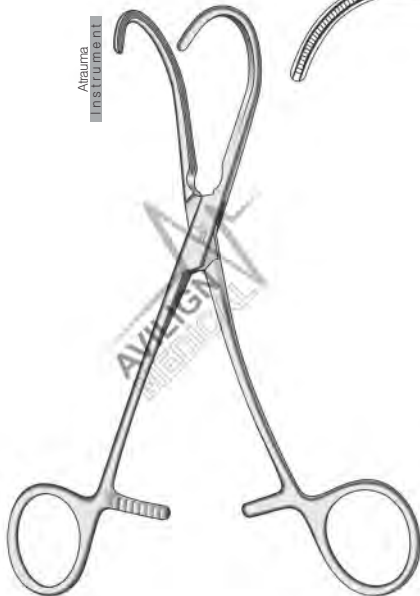

De Bakey

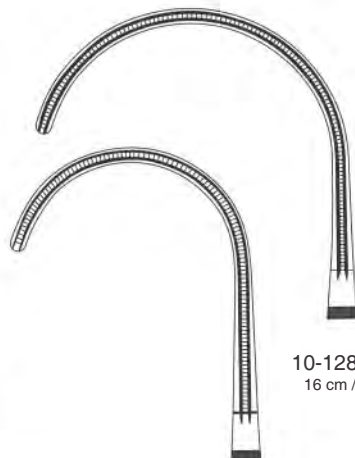

10-1280-16
16 cm / 6½"

10-1280-17
17 cm / 6¾"

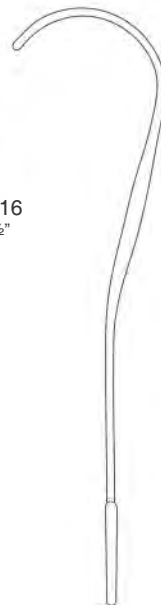

10-1290-17
17 cm / 6¾"

Atrauma
Instrument



Glover

Atraumatische Gefäßklemmen
 Pinzas vasculares atraumáticas
 Pinze vascolari atraumatiche
 Atraumatic Vascular Cclamps

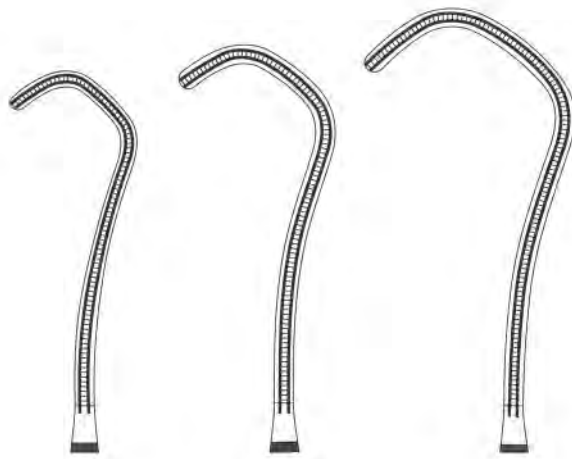

10-1300-16
 16.5 cm / 6½"

10-1300-17
 17 cm / 6¾"

10-1300-18
 18 cm / 7"

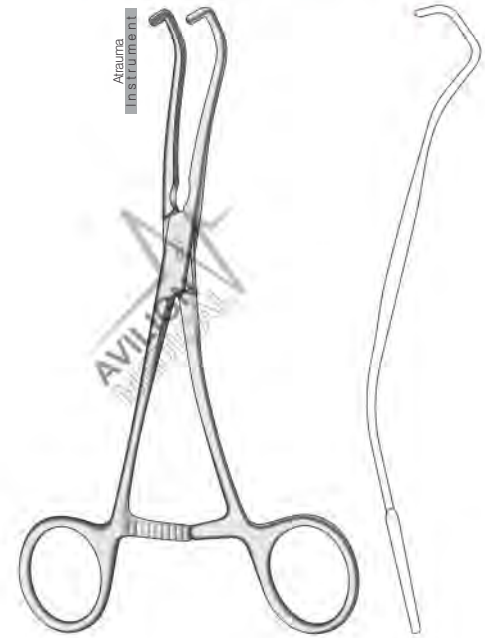

Derra

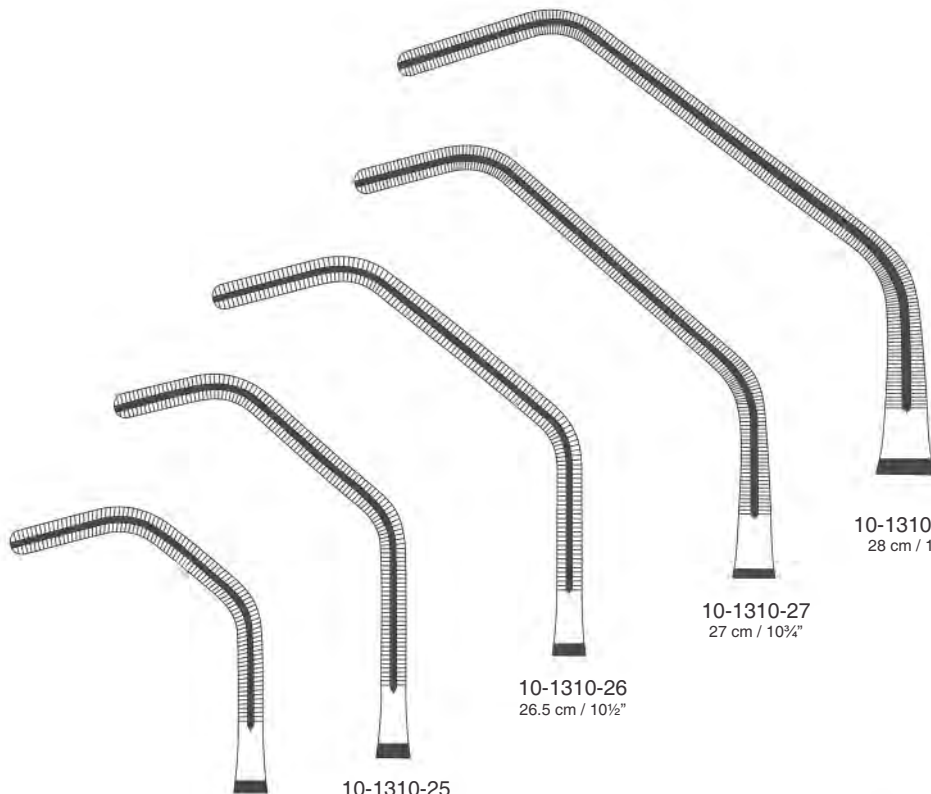

10-1310-20
 20 cm / 8"

10-1310-25
 25 cm / 9¾"

10-1310-26
 26.5 cm / 10½"

10-1310-27
 27 cm / 10¾"

10-1310-28
 28 cm / 11"



Cooley

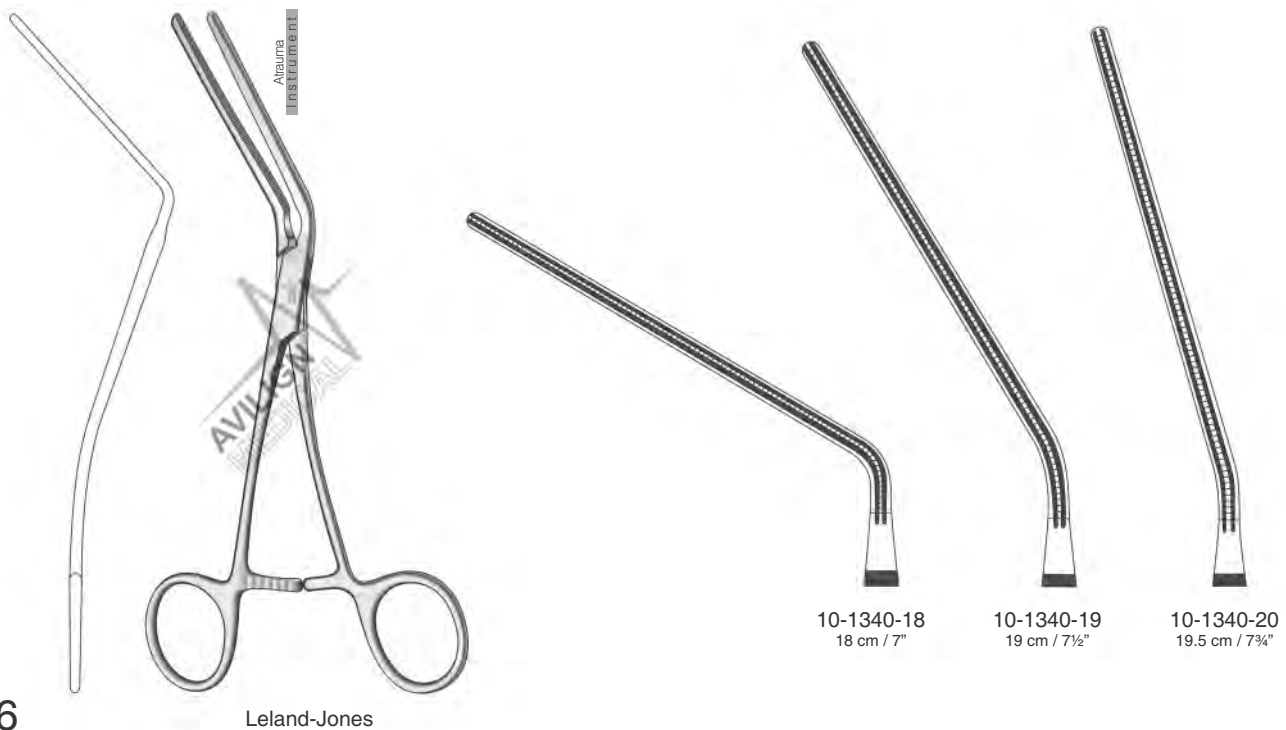
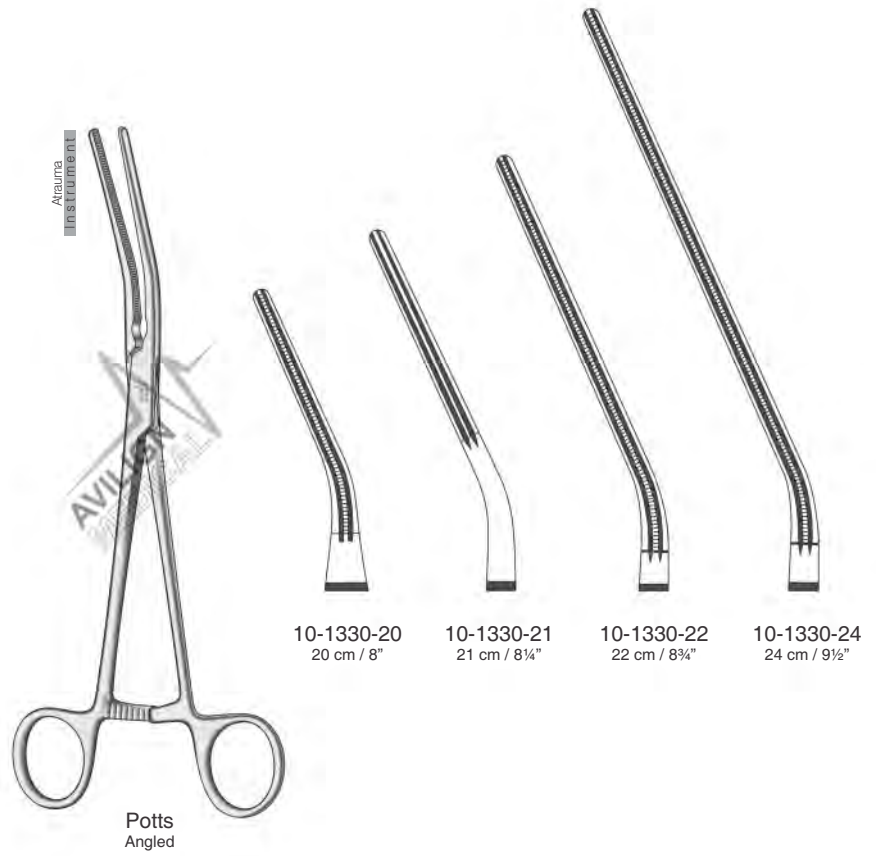
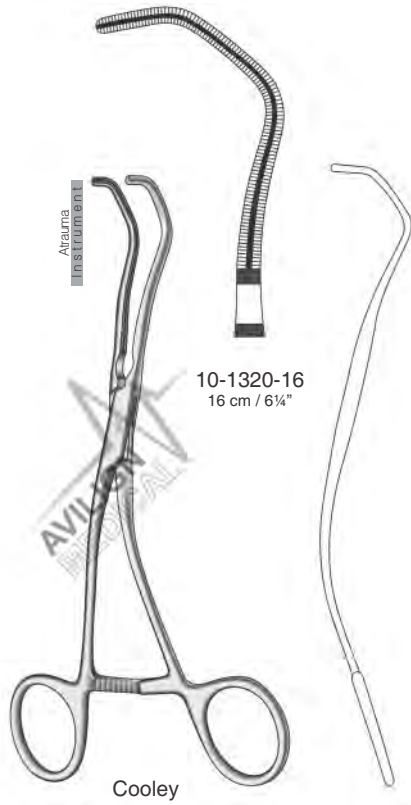

Atraumatische Gefäßklemmen
 Pinzas vasculares atraumáticas
 Pinze vascolari atraumatiche
 Atraumatic Vascular Clamps

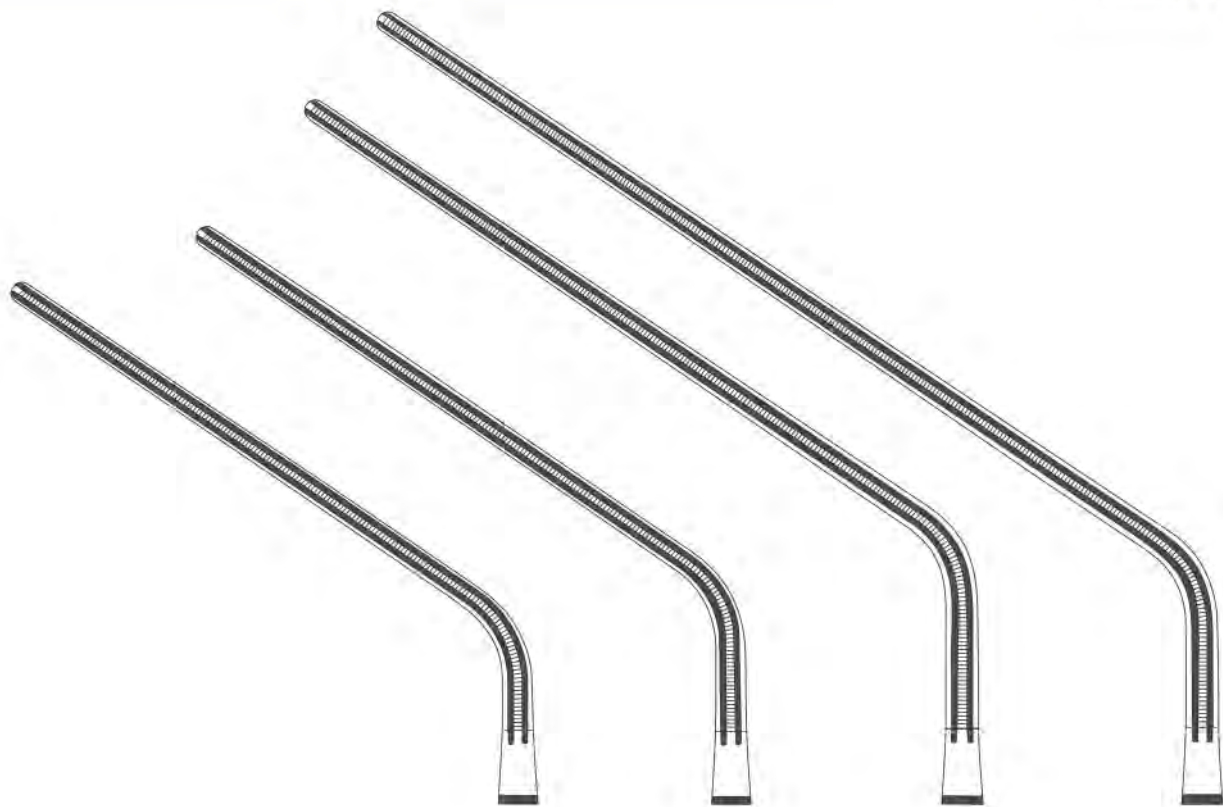

10-1350-25
 25 cm / 9¾"
 Angled at 60°

10-1350-28
 28 cm / 11"
 Angled at 60°

10-1350-29
 29 cm / 11¼"
 Angled at 60°

10-1350-30
 30 cm / 12"
 Angled at 60°

Atrauma Instrument



De Bakey



10-1350-20
 20 cm / 8"
 Angled at 60°

10-1350-21
 21 cm / 8¼"
 Angled at 60°

10-1350-23
 23 cm / 9"
 Angled at 60°

10-1350-24
 24 cm / 9½"
 Angled at 60°

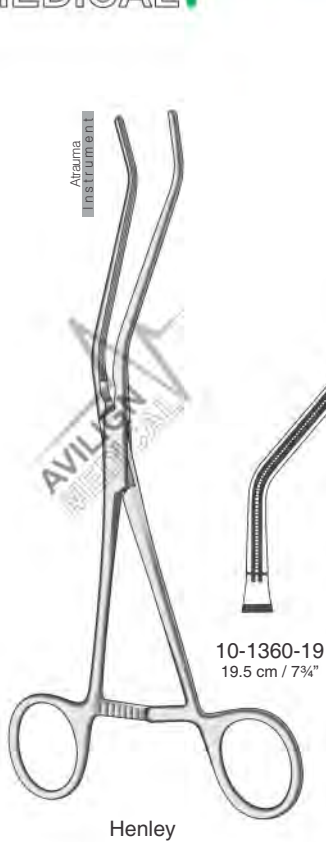

Henley



De Bakey-Satinsky

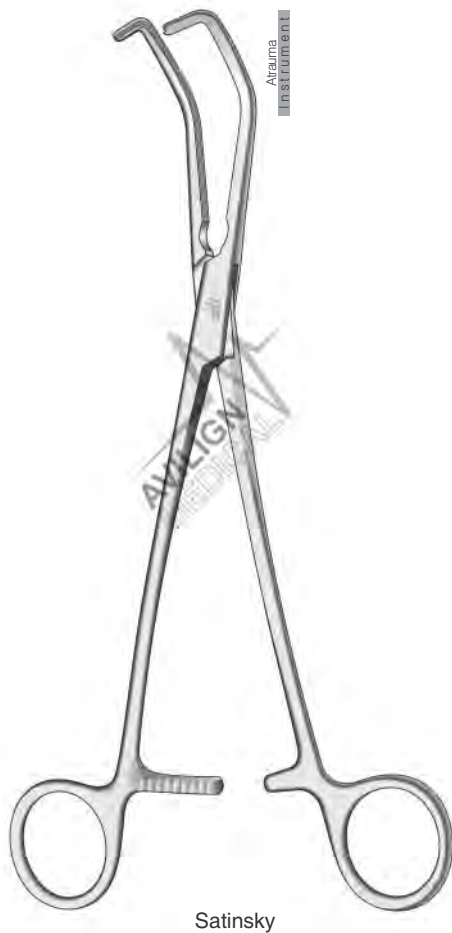
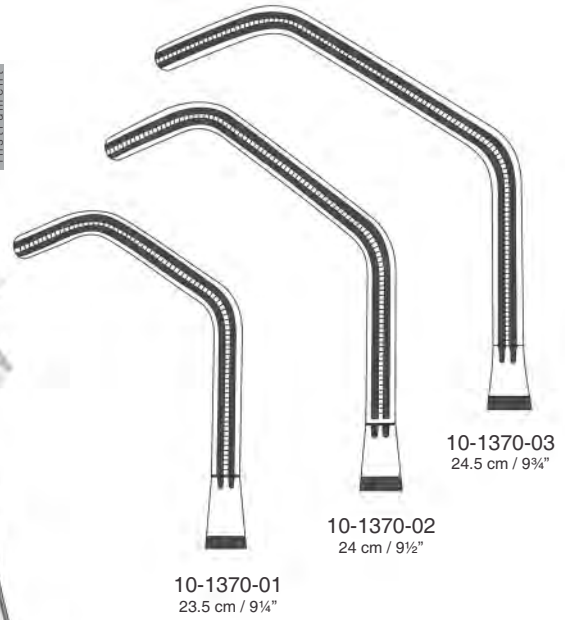

Satinsky

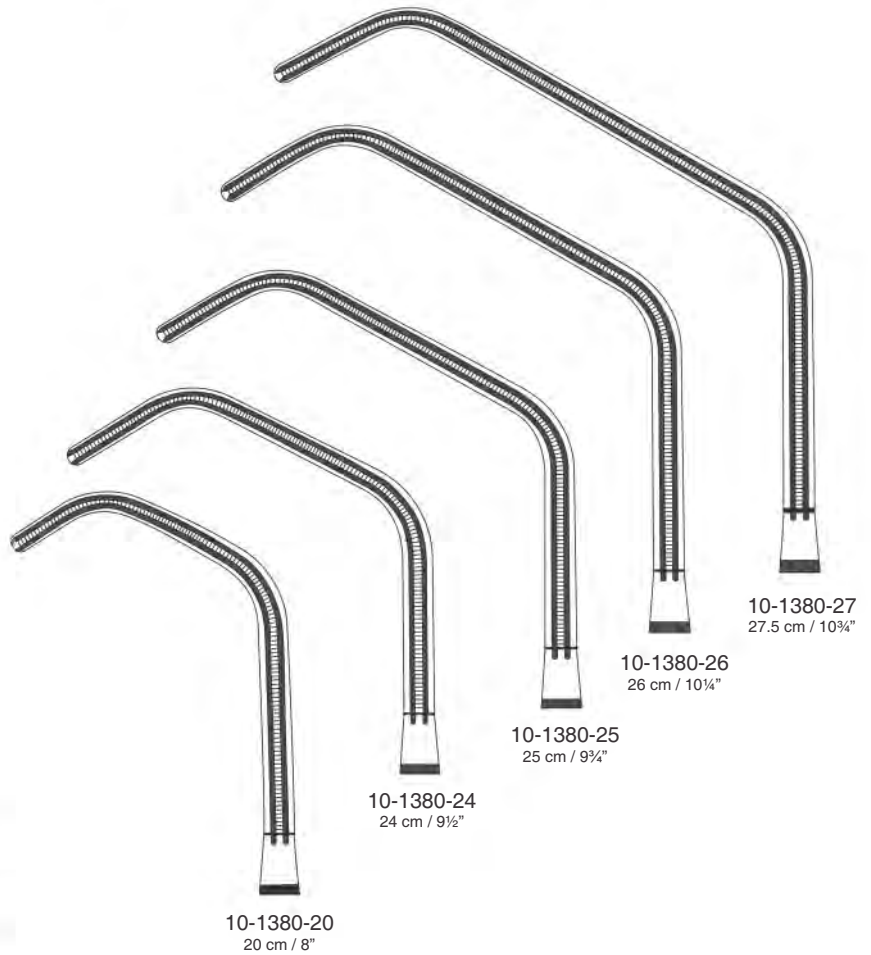



Cooley



10-1390-02
 16 cm / 6¼"

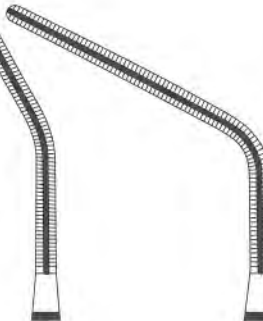

10-1390-03
 15.5 cm / 6"



10-1390-04
 15.5 cm / 6"



10-1390-05
 16 cm / 6¼"

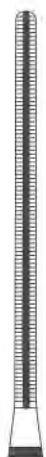

10-1400-01
 16.5 cm / 6½"



Cooley
 Straight



10-1410-02
 17 cm / 6¾"



Cooley
 Curved

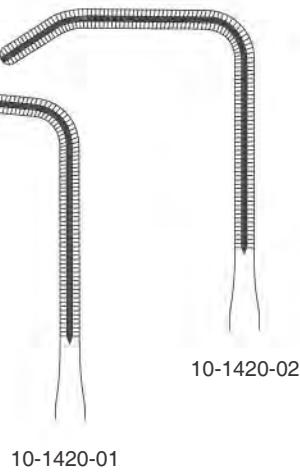

10-1420-02

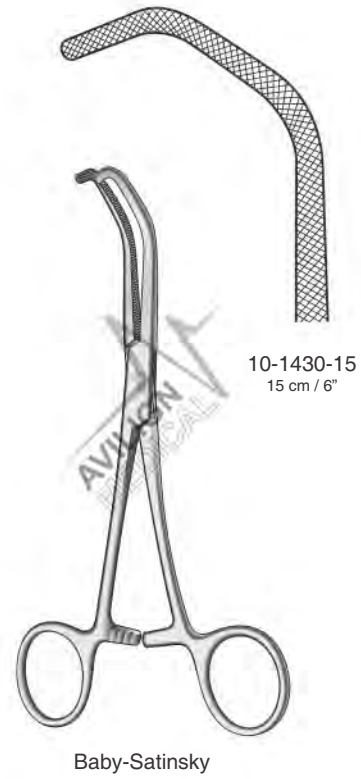

10-1430-15
15 cm / 6"

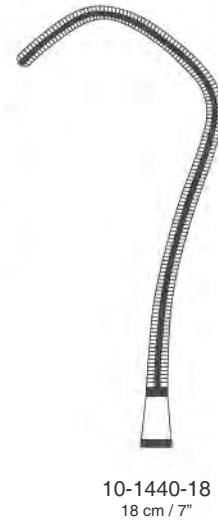
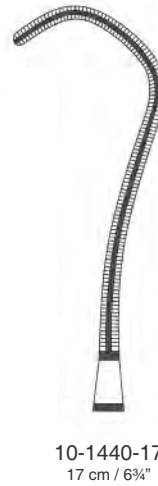

Tupferzangen, Kornzangen
 Pinzas para tapones, Pinzas para vendajes
 Pinze per tamponi, Pinze per medicazione
 Sponge & Dressing Forceps



Ulrich

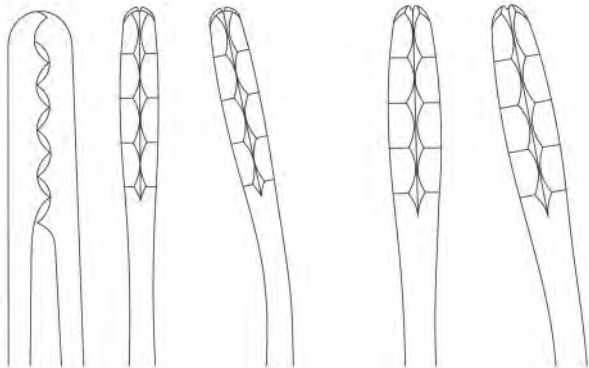

10-1450-22
 22.5 cm / 9"

10-1460-22
 22.5 cm / 9"

10-1470-27
 26.5 cm / 10½"

10-1480-27
 26.5 cm / 10½"

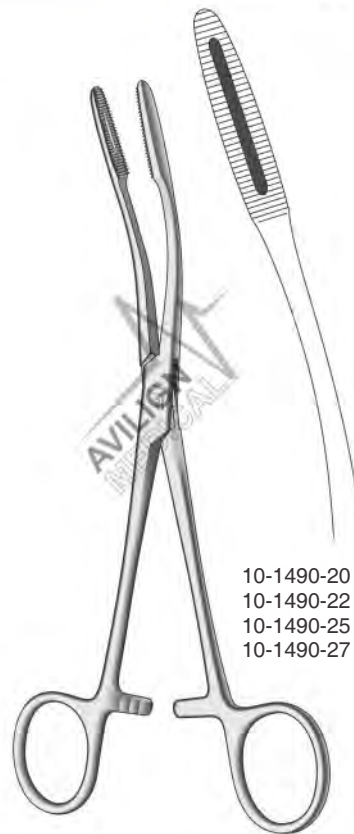

Gross-Maier

10-1490-20 20 cm / 8"
 10-1490-22 22 cm / 8¾"
 10-1490-25 25 cm / 9¾"
 10-1490-27 27 cm / 10¾"



10-1500-14 14 cm / 5¾"
 10-1500-16 16 cm / 6¼"
 10-1500-18 18 cm / 7"
 10-1500-20 20 cm / 8"
 10-1500-25 25 cm / 9¾"

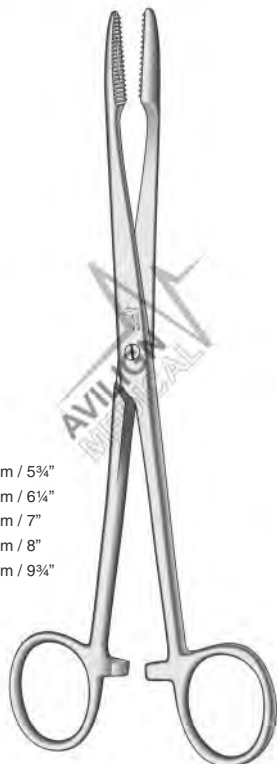

Gross



10-1510-14 14.5 cm / 5¾"
 10-1510-18 18 cm / 7"
 10-1510-20 20 cm / 8"
 10-1510-25 25 cm / 9¾"



Gross

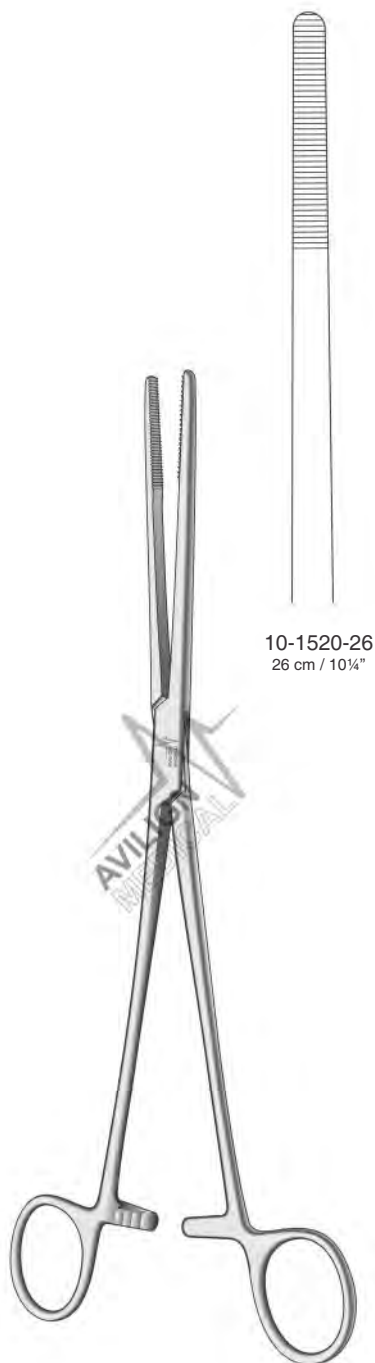

10-1520-26
26 cm / 10¼"

Bozemann

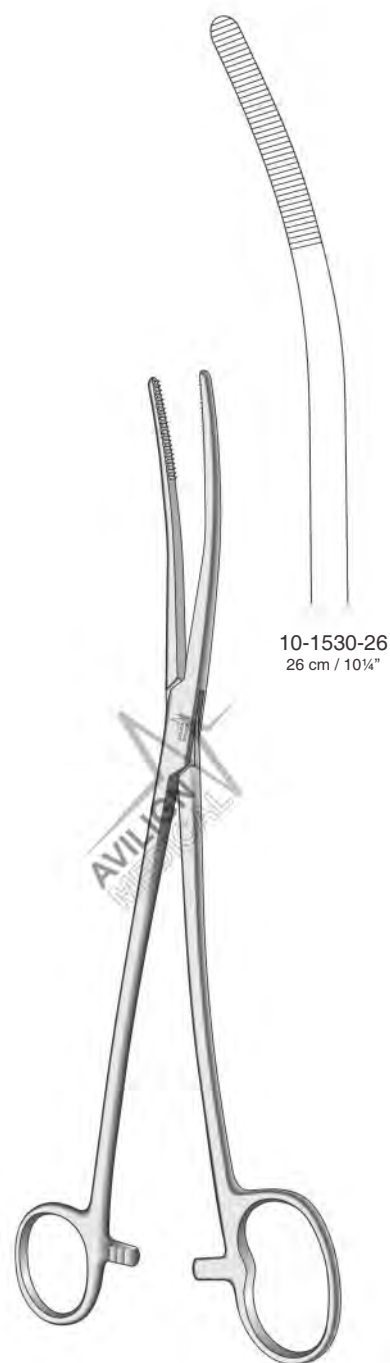

10-1530-26
26 cm / 10¼"

Bozemann-Douglas

Tupferzangen, Kornzangen, Organfasszangen
 Pinzas para tapones, Pinzas para vendajes, Pinzas para sacar órganos
 Pinze per tamponi, Pinze per medicazione, Pinze per afferrare organi
 Sponge & Dressing Forceps, Organ Grasping Forceps

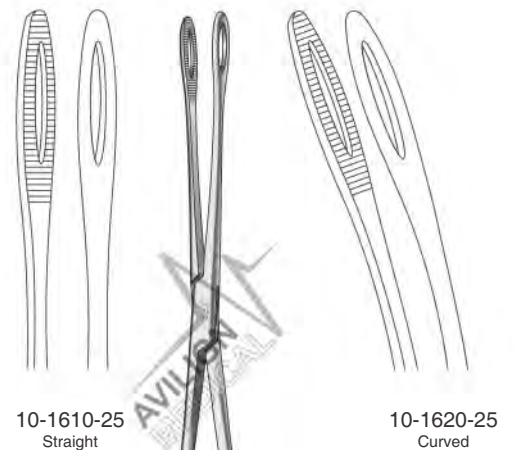
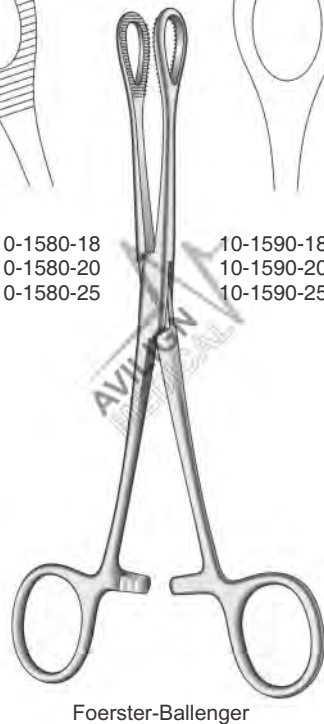
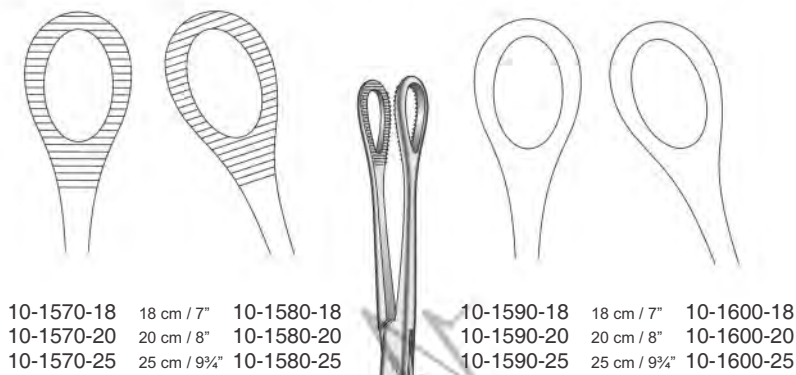
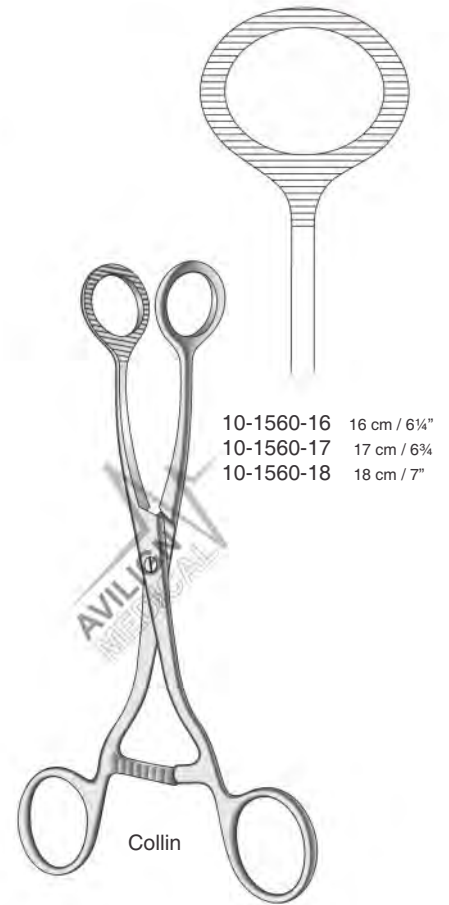
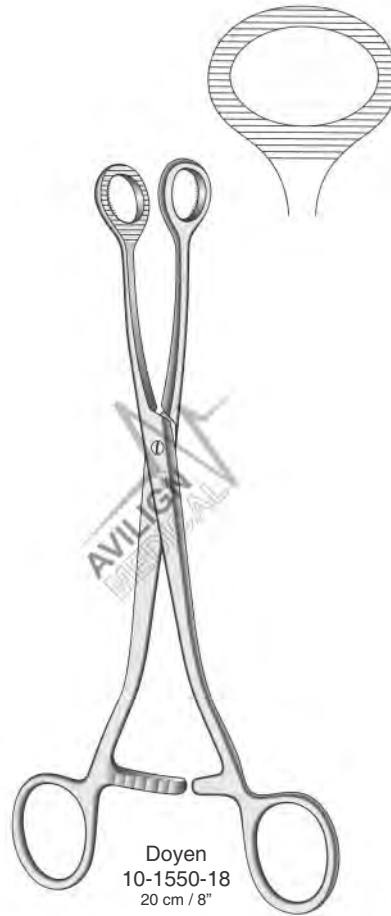
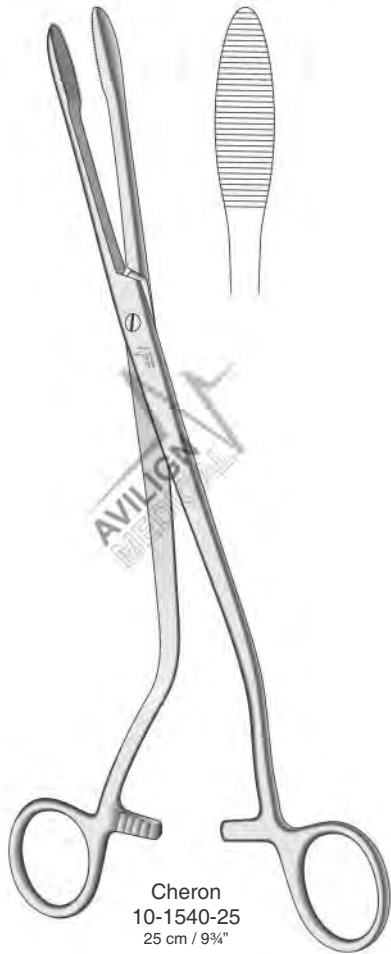

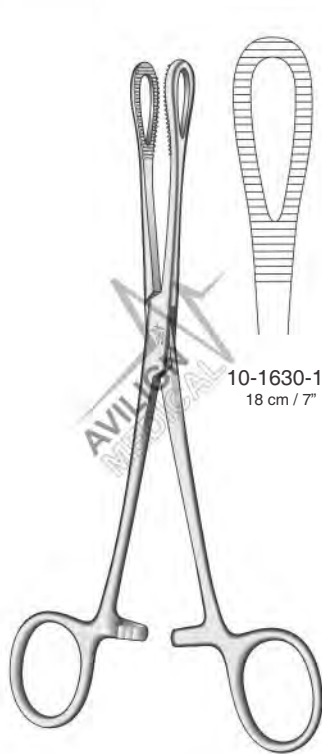

10-1630-18
18 cm / 7"

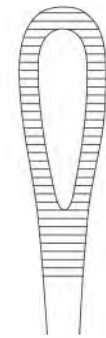

10-1630-25
25 cm / 9¾"



10-1640-24
24 cm / 9½"

Rampley

Bonney

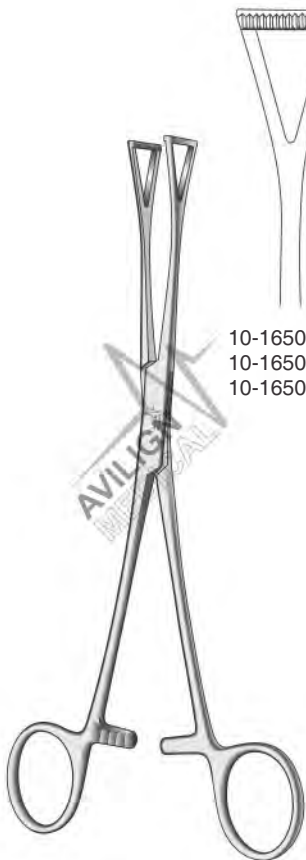

10-1650-14 14 cm / 5½"
 10-1650-18 18 cm / 7"
 10-1650-20 20 cm / 8"

Duval



Tungsten Carbide
Gold Rings

10-1660-20
20 cm / 8"

Duval

Darm - und Gewebefaßzangen
 Pinzas intestinales y para tejidos
 Pinze da presa per intestino e tessuti
 Intestinal & Tissue Grasping Forceps



10-1670-01
 15 mm



10-1670-02
 20 mm

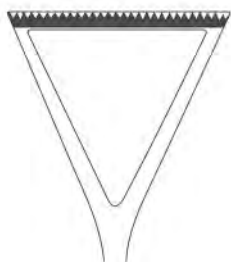

10-1670-03
 30 mm



Duval-Collin
 19 cm / 7½"



10-1680-14
 14 cm / 5½"



Collin

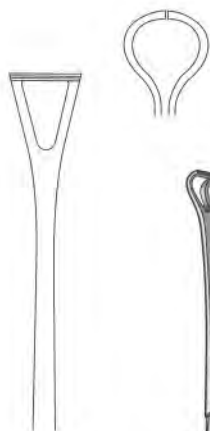

10-1690-16 16 cm / 6¼"
 10-1690-18 18 cm / 7"
 10-1690-20 20 cm / 8"
 10-1690-24 24 cm / 9½"
 10-1690-36 36 cm / 14"
 10-1690-40 40 cm / 16"

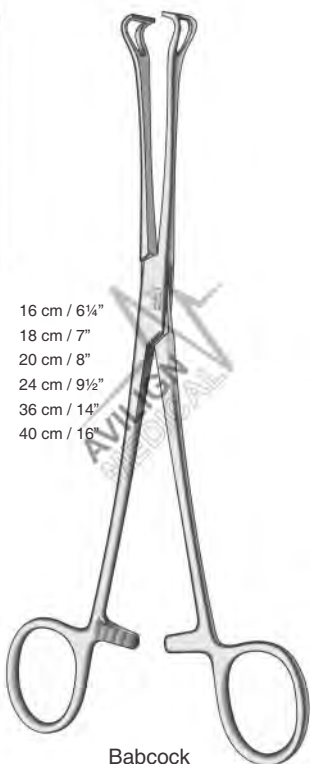

Babcock



10-1700-16
 16 cm / 6¼"



10-1700-20
 20 cm / 8"



10-1700-22
 22 cm / 8¾"



Babcock

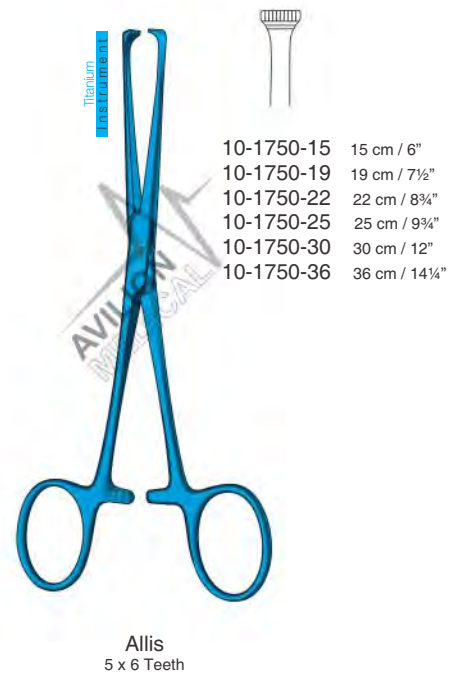
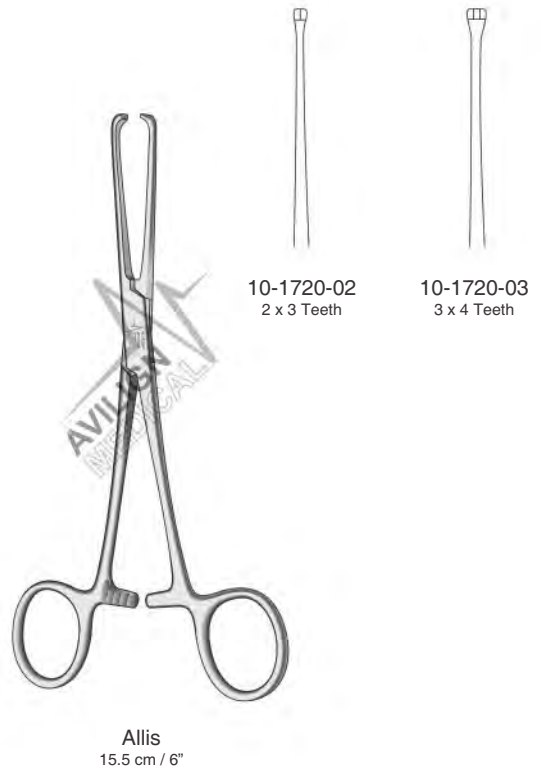
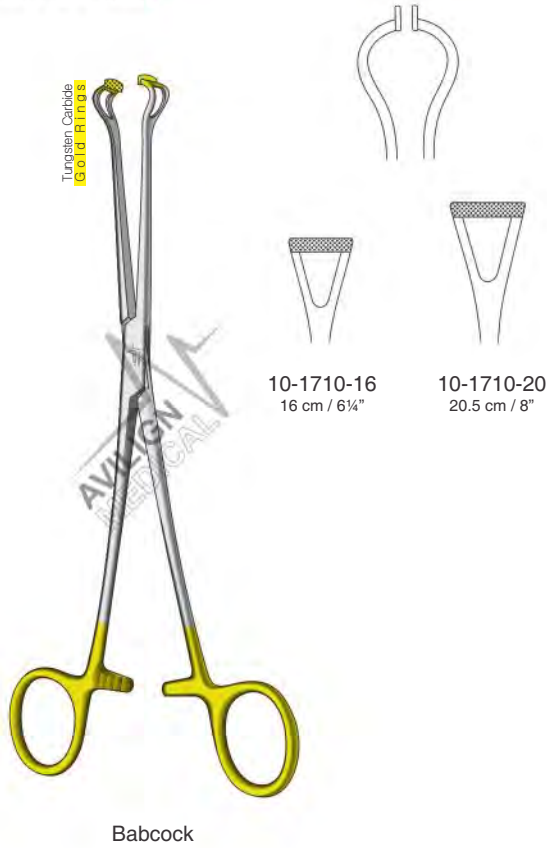

Darm - und Gewebefaßzangen, Tuchklemmen
 Pinzas intestinales y para tejidos, Pinzas de campo
 Pinze da presa per intestino e tessuti, Pinze fissatele
 Intestinal & Tissue Grasping Forceps, Towel Clamps



- 10-1760-16 16 cm / 6¼"
- 10-1760-20 20 cm / 8"
- 10-1760-22 22 cm / 8¾"
- 10-1760-25 25 cm / 9¾"
- 10-1760-30 30 cm / 11¾"



Allis

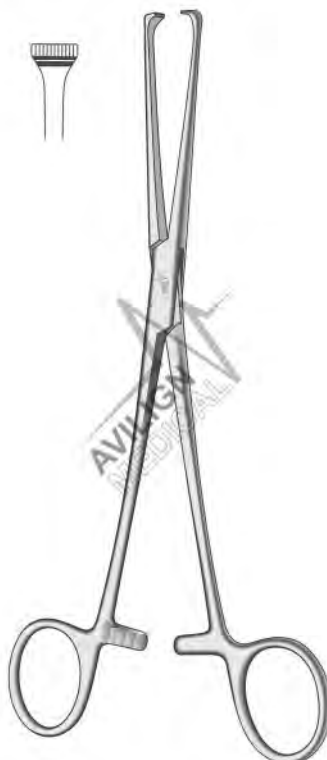

Thoms-Allis
 10-1770-20
 20 cm / 8"
 6 x 7 Teeth



- 10-1780-21 20 cm / 8"
- 10-1780-22 22 cm / 8¾"

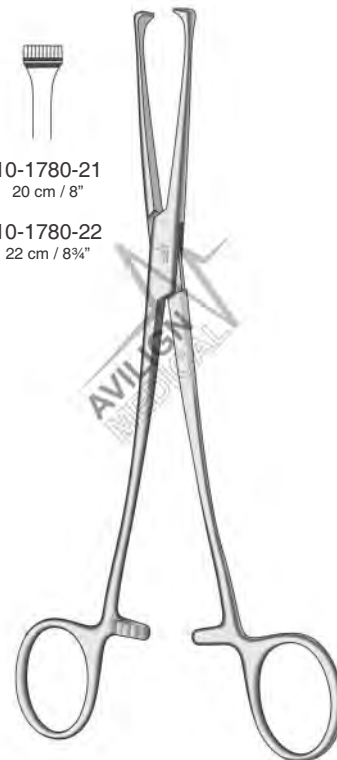

Allis
 5 x 6 Teeth



Chaput
 10-1790-13
 13 cm / 5"
 2 x 3 Teeth



- 10-1800-08 8 cm / 3"
- 10-1800-11 11 cm / 4¼"
- 10-1800-13 13 cm / 5"
- 10-1800-15 15 cm / 6"

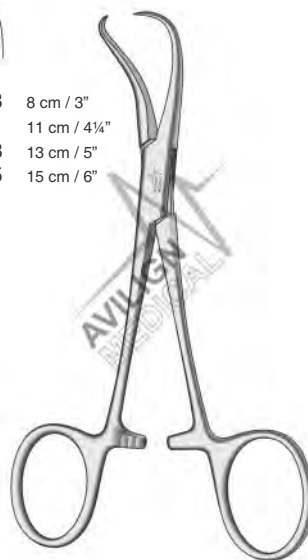

Backhaus

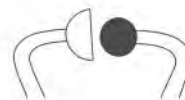

- 10-1810-11 11 cm / 4¼"
- 10-1810-14 14 cm / 5½"



Ball & Socket



Jones
10-1820-05 5.5 cm / 2¼"
10-1820-09 9 cm / 3½"

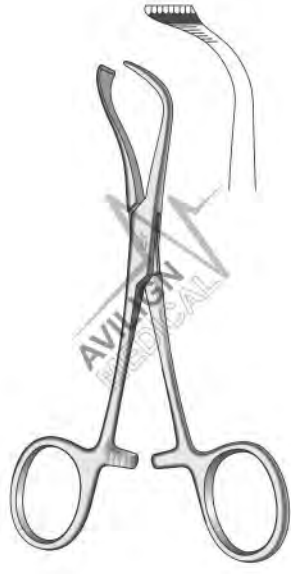

Lorna (Edna)
10-1830-10 9.5 cm / 3¾"
10-1830-13 13 cm / 5"



Hoff
10-1840-10 10 cm / 4"
10-1840-12 12 cm / 4¾"
10-1840-14 14 cm / 5½"

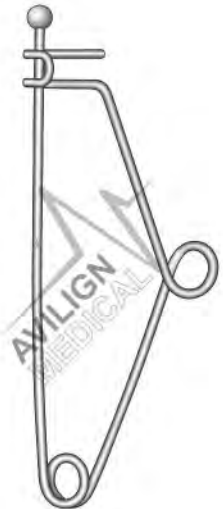

Mayo
10-1850-13
13 cm / 5"



Mayo
10-1860-14
14 cm / 5½"

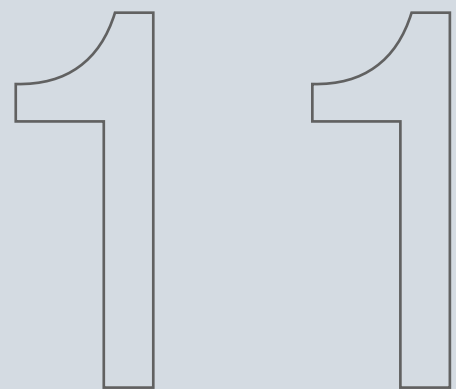

Retractors

Wundhaken
Separadores
Divaricatori



11-0010-01
Sharp



11-0020-01
Semi-Sharp



11-0030-01
Blunt



11-0010-02



11-0020-02



11-0030-02



11-0010-03



11-0020-03



11-0030-03



11-0010-04



11-0020-04

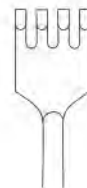

11-0030-04

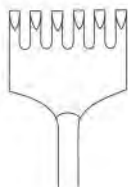

11-0010-06

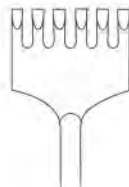

11-0020-06

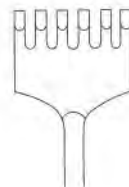

11-0030-06

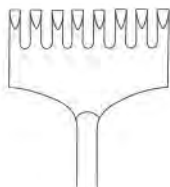

11-0010-08

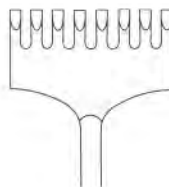

11-0020-08

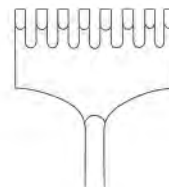

11-0030-08



Volkman
22 cm / 8 3/4"



11-0040-01
Sharp



11-0050-01
Semi-Sharp



11-0060-01
Blunt



11-0040-02



11-0050-02



11-0060-02



11-0040-03



11-0050-03



11-0060-03



11-0040-04



11-0050-04



11-0060-04

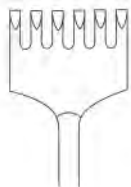

11-0040-06

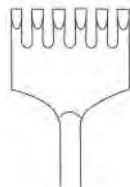

11-0050-06

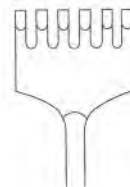

11-0060-06

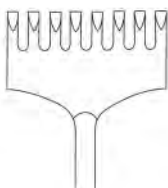

11-0040-08

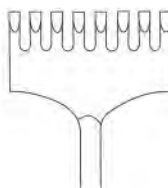

11-0050-08

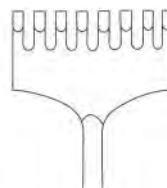

11-0060-08



Kocher
22 cm / 8³/₄"



11-0070-01
Sharp



11-0080-01
Blunt

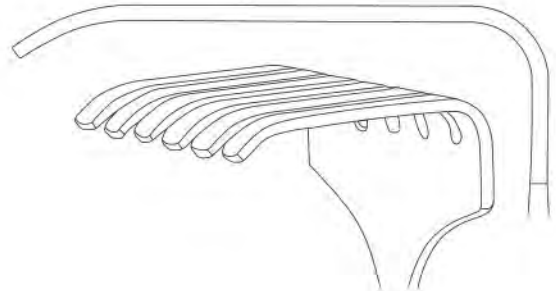

11-0090-07
70 x 70 mm



11-0070-02



11-0080-02

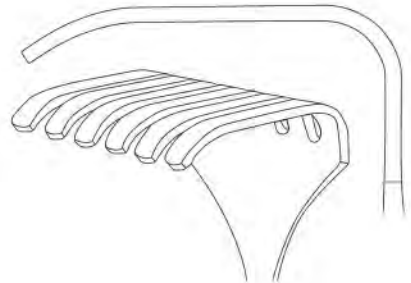

11-0090-06
50 x 60 mm

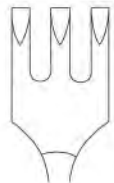

11-0070-03

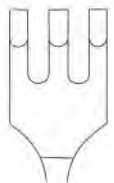

11-0080-03



Israel
25.5 cm / 10"



11-0070-04

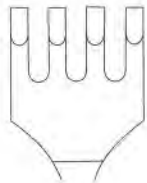

11-0080-04

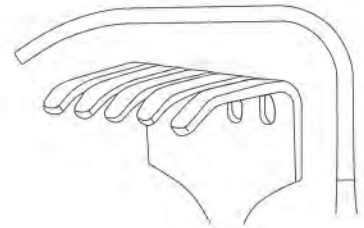

11-0090-05
40 x 50 mm

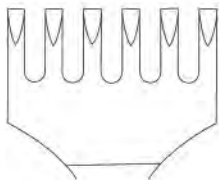

11-0070-06

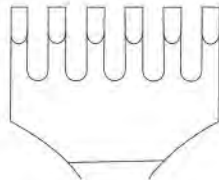

11-0080-06

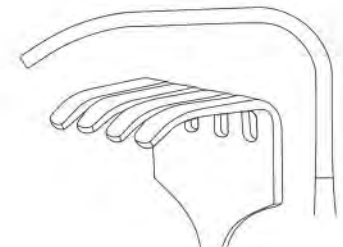

11-0090-04
40 x 40 mm



Volkman
22 cm / 8 3/4"

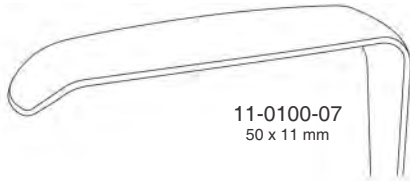

11-0100-07
 50 x 11 mm

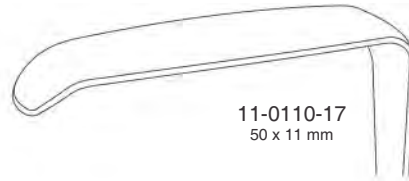

11-0110-17
 50 x 11 mm

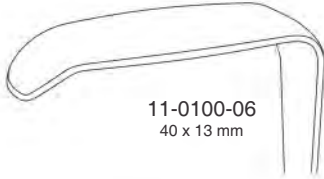

11-0100-06
 40 x 13 mm

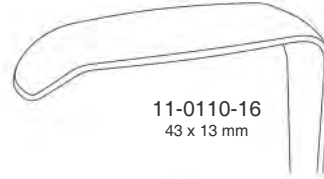

11-0110-16
 43 x 13 mm

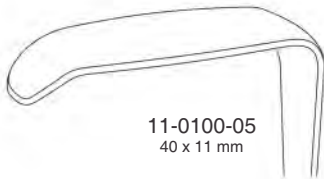

11-0100-05
 40 x 11 mm

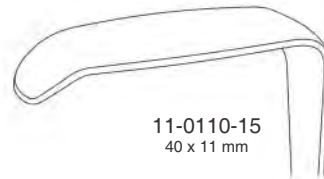

11-0110-15
 40 x 11 mm

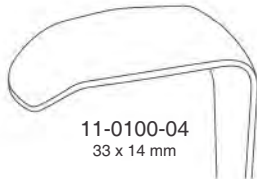

11-0100-04
 33 x 14 mm

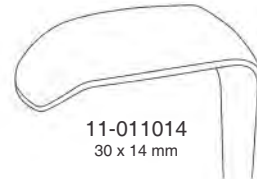

11-0110-14
 30 x 14 mm

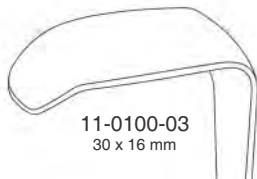

11-0100-03
 30 x 16 mm

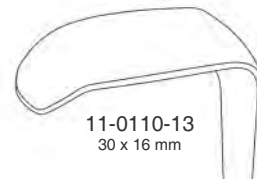

11-0110-13
 30 x 16 mm

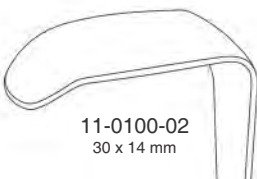

11-0100-02
 30 x 14 mm

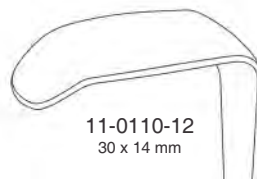

11-0110-12
 30 x 14 mm

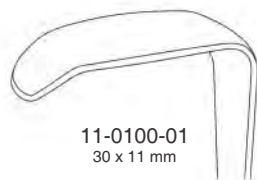

11-0100-01
 30 x 11 mm

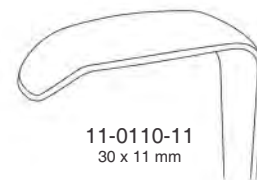

11-0110-11
 30 x 11 mm



Langenbeck
 22.5 cm / 8¾"



Langenbeck
 22.5 cm / 8¾"

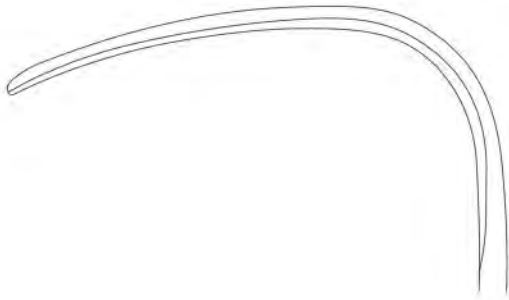

65 x 20 mm
11-0120-01
21 cm / 8 1/4"

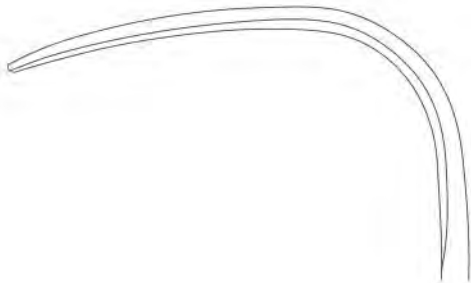

55 x 20 mm
11-0120-02
22 cm / 8 3/4"



Langenbeck



11-0130-10
80 x 16 mm



11-0130-09
80 x 12 mm



11-0130-08
70 x 14 mm



11-0130-07
55 x 11 mm



11-0130-06
40 x 11 mm



11-0130-05
35 x 15 mm

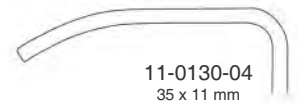

11-0130-04
35 x 11 mm



11-0130-03
35 x 8 mm

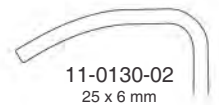

11-0130-02
25 x 6 mm



11-0130-01
23 x 8 mm



Kocher-Langenbeck
21.5 cm / 8 1/2"

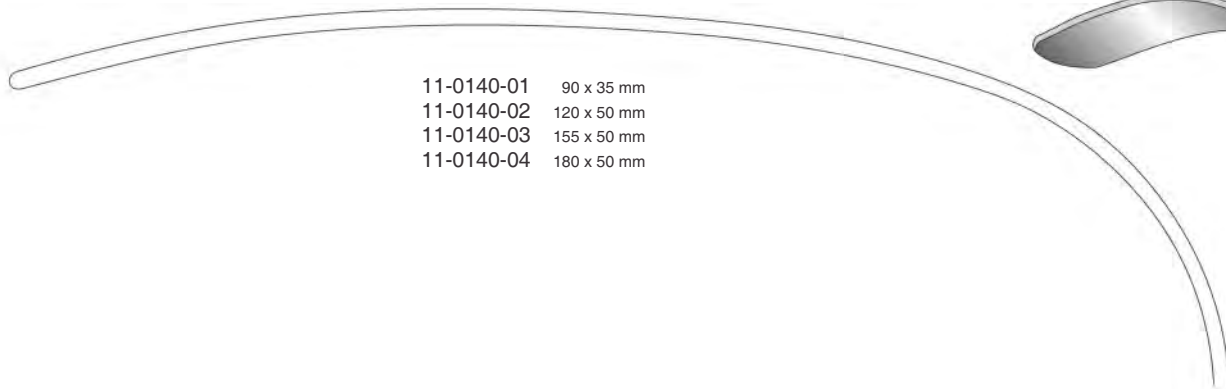

11-0140-01 90 x 35 mm
 11-0140-02 120 x 50 mm
 11-0140-03 155 x 50 mm
 11-0140-04 180 x 50 mm

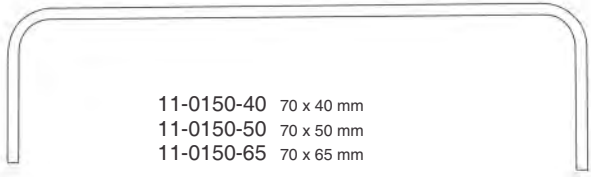

11-0150-40 70 x 40 mm
 11-0150-50 70 x 50 mm
 11-0150-65 70 x 65 mm

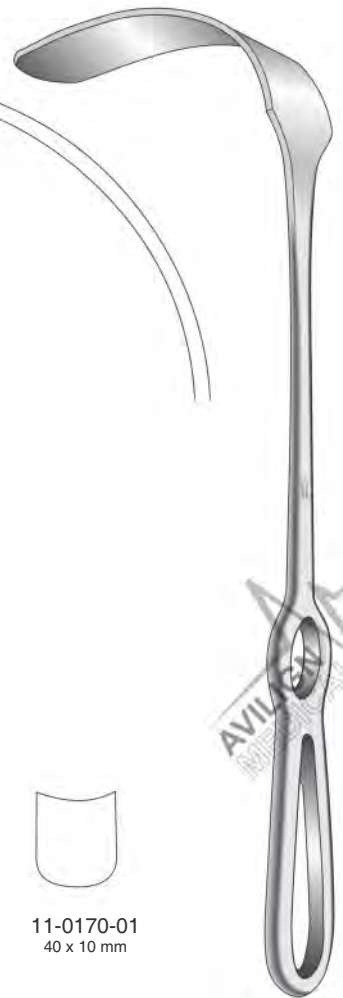

Mikulicz
 26 cm / 10½"



Morris
 24 cm / 9½"

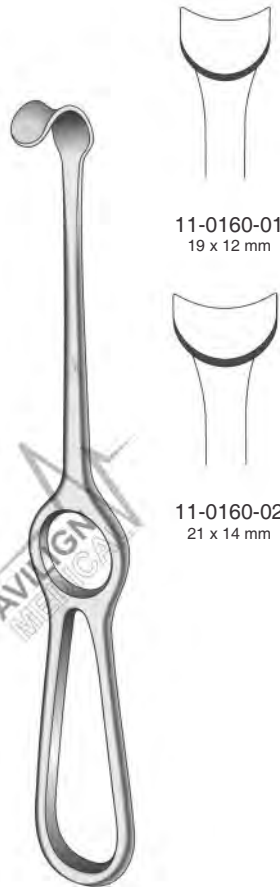

11-0160-01
 19 x 12 mm

11-0160-02
 21 x 14 mm

Kocher
 21 cm / 8¼"

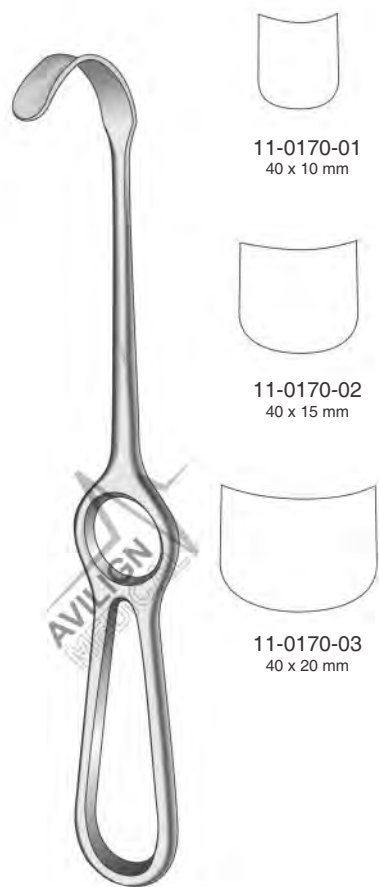

11-0170-01
 40 x 10 mm

11-0170-02
 40 x 15 mm

11-0170-03
 40 x 20 mm

Kocher
 22 cm / 8¾"

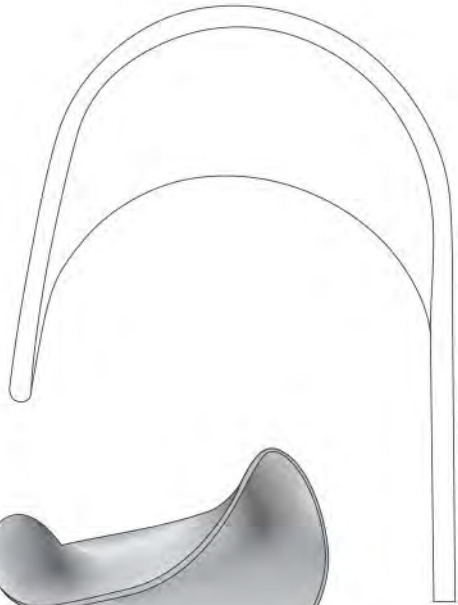

11-0180-25
53 x 80 mm



Doyen
25 cm / 10"



11-0190-26
78 x 82 mm



Doyen
26 cm / 10 1/4"



Fritsch

- 11-0200-00 23.5 cm / 9¼"
31 x 37 mm
- 11-0200-01 24 cm / 9½"
40 x 38 mm
- 11-0200-02 25 cm / 9¾"
51 x 43 mm
- 11-0200-03 25 cm / 9¾"
61 x 49 mm
- 11-0200-04 25.5 cm / 10"
75 x 48 mm
- 11-0200-05 26.5 cm / 10½"
85 x 65 mm

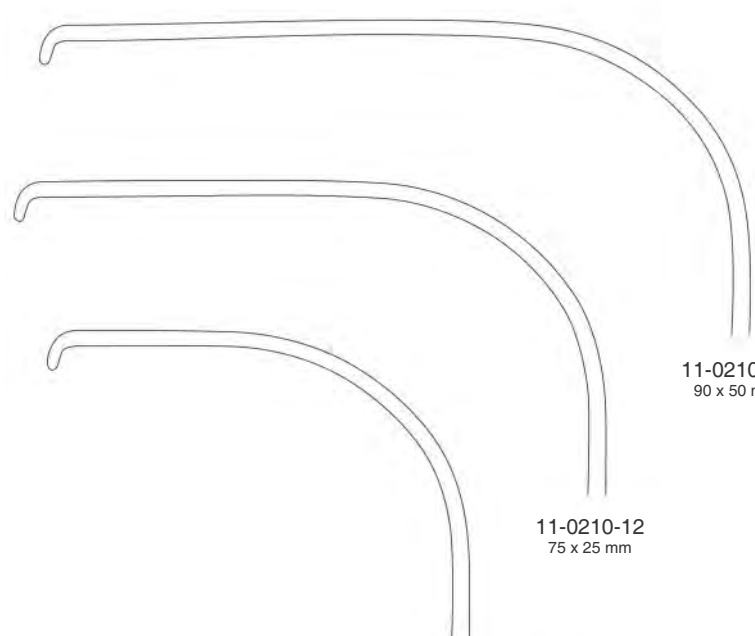

11-0210-11
50 x 16 mm

11-0210-12
75 x 25 mm

11-0210-13
90 x 50 mm



Meyerding
23 cm / 9"



- 11-0220-01 190 x 38 mm
- 11-0220-02 190 x 57 mm
- 11-0220-03 150 x 38 mm
- 11-0220-04 150 x 57 mm

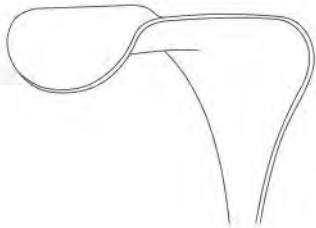

11-0230-15
65 x 50 mm

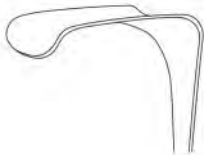

11-0230-14
52 x 22 mm

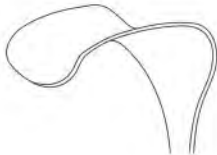

11-0230-13
44 x 38 mm



11-0230-12
36 x 28 mm



11-0230-11
28 x 20 mm



AVILIGN
MEDICAL

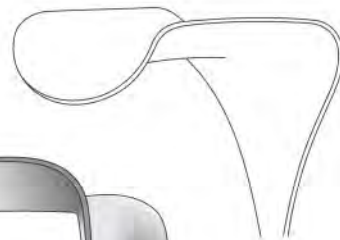

11-0240-26

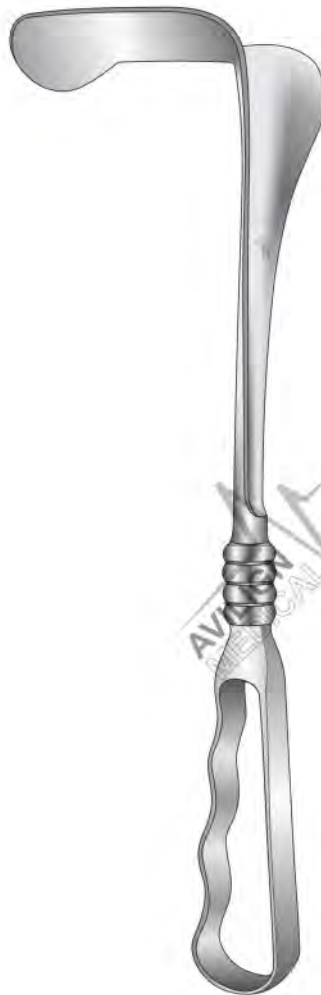

AVILIGN
MEDICAL

Kelly
26 cm / 10¼"
51 x 64 mm

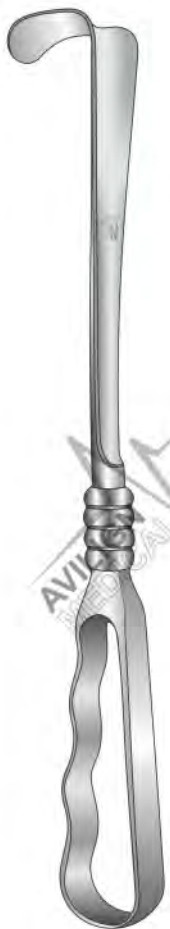

Richardson
24 cm / 9½"

AVILIGN
MEDICAL

Kelly
27 cm / 10½"

Wundhaken
 Separadores
 Divaricatori
 Retractors



11-0250-01 19 cm / 7½"
 75 x 50 mm

11-0250-02 18.5 cm / 7¼"
 75 x 90 mm

Davidson



Parker-Langenbeck
 11-0270-00
 21 cm / 8½"

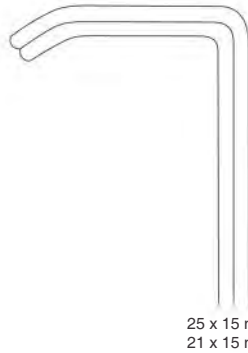

40 x 15 mm
 45 x 15 mm

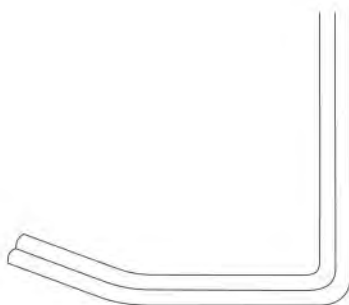

Ragnell
 11-0260-15
 15 cm / 6"

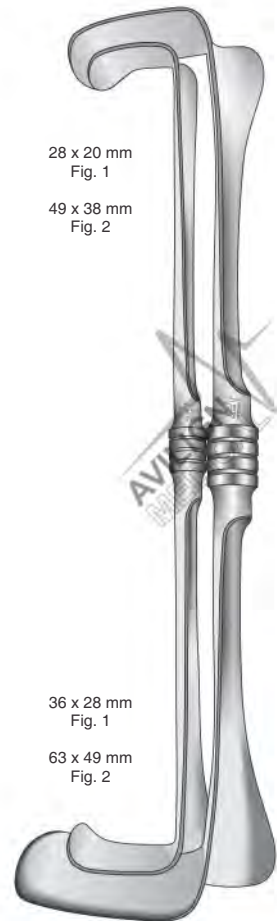

Richardson-Eastman
 11-0280-00 Set
 11-0280-01 26 cm / 10¼"
 11-0280-02 27 cm / 10¾"

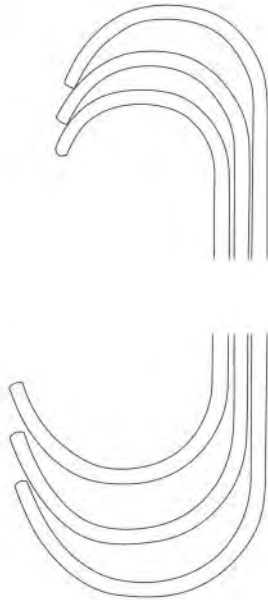

Roux

- 11-0290-00 Set of 3
- 11-0290-01 14 cm / 5½"
- 11-0290-02 15 cm / 6"
- 11-0290-03 17 cm / 6¾"

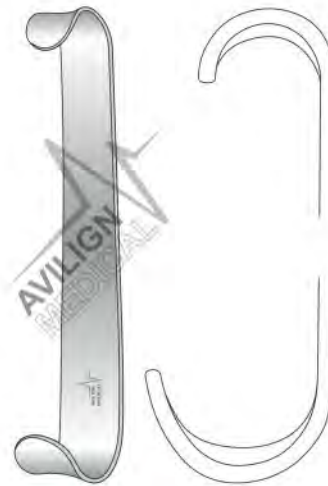

Baby-Roux
11-0300-01
12.5 cm / 5"



Parker
11-0310-00
17.5 cm / 7"

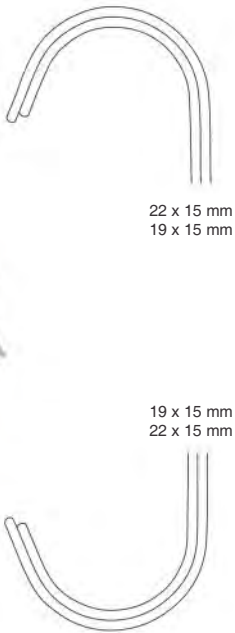
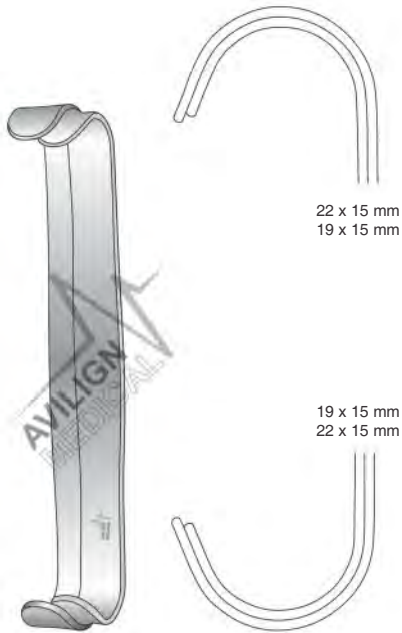

22 x 15 mm
19 x 15 mm

19 x 15 mm
22 x 15 mm

Parker-Baby
11-0320-01
13.5 cm / 5¼"

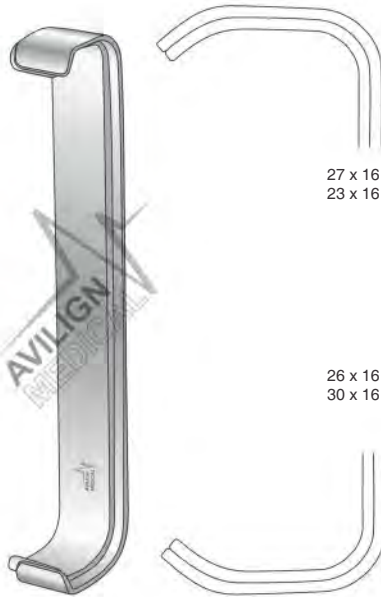

27 x 16 mm
23 x 16 mm

26 x 16 mm
30 x 16 mm

Farabeuf
11-0330-00
15 cm / 6"

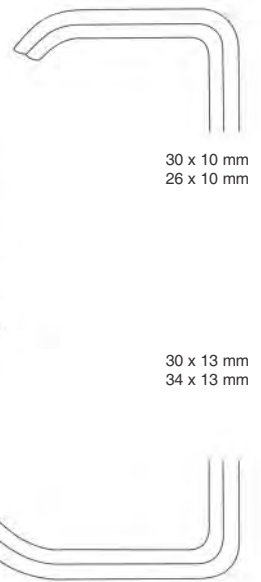

30 x 10 mm
26 x 10 mm

30 x 13 mm
34 x 13 mm

Farabeuf
11-0340-00
11.5 cm / 4½"

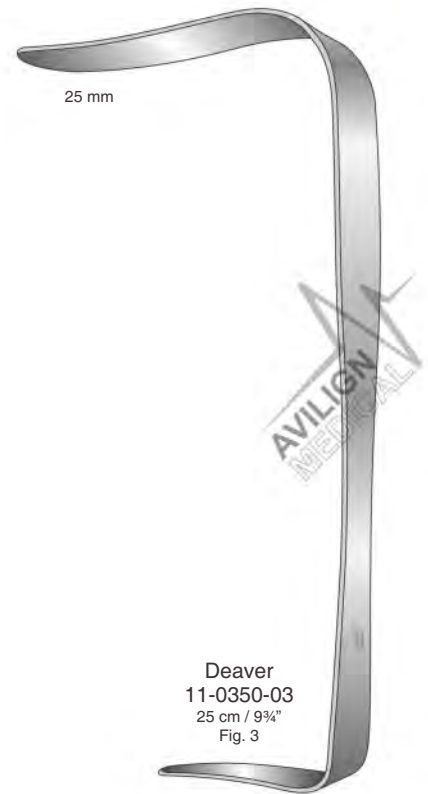





11-0370-01
 Fig. 1



11-0370-02
 Fig. 2



11-0370-03
 Fig. 3



11-0380-01
 13 cm / 5"
 Fig. 1



11-0380-02
 14 cm / 5½"
 Fig. 2



11-0380-03
 14 cm / 5½"
 Fig. 3



Lucae
 14 cm / 5½"



Graefe



11-0390-01
 Fig. 1



11-0390-02
 Fig. 2



Cushing
 19 cm / 7½"



11-0400-01
 20 cm / 8"



Crile



11-0410-01
 Fig. 1



11-0410-02
 Fig. 2



Cushing
 28 cm / 11"

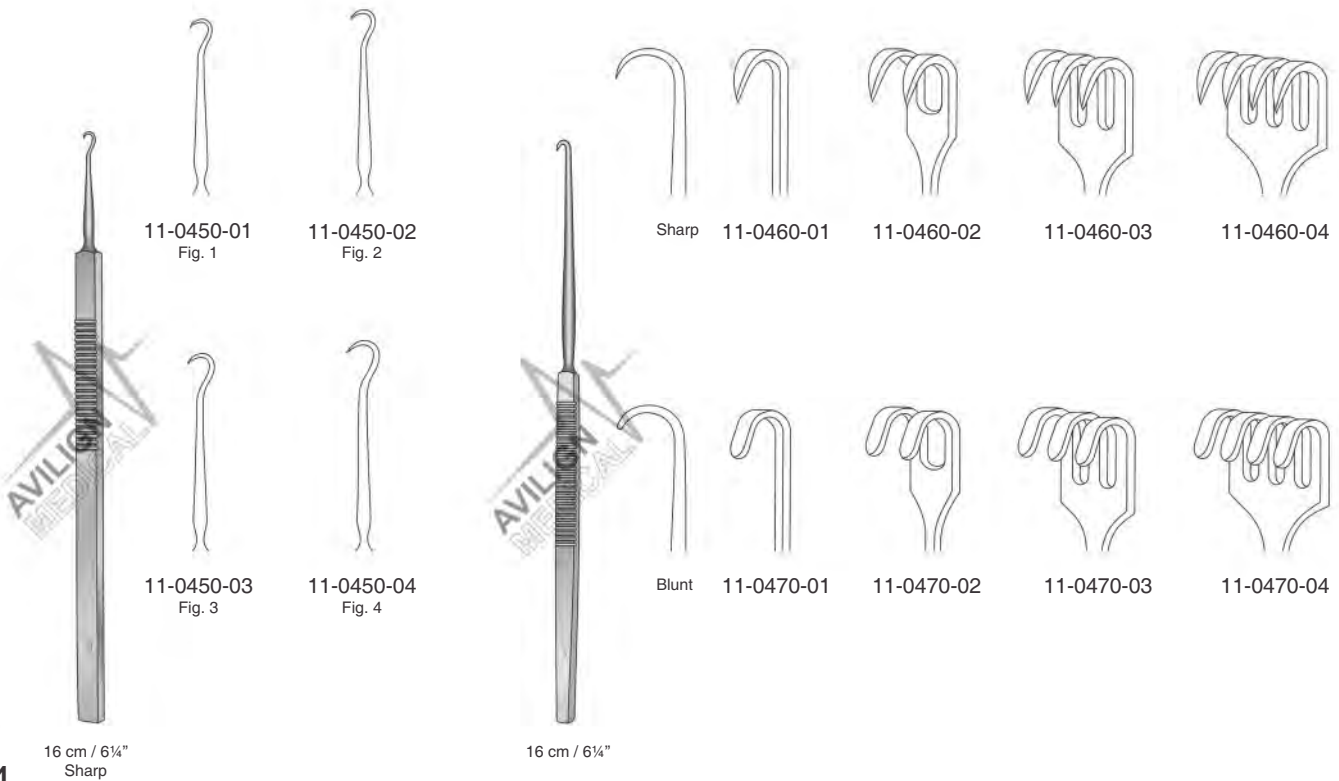
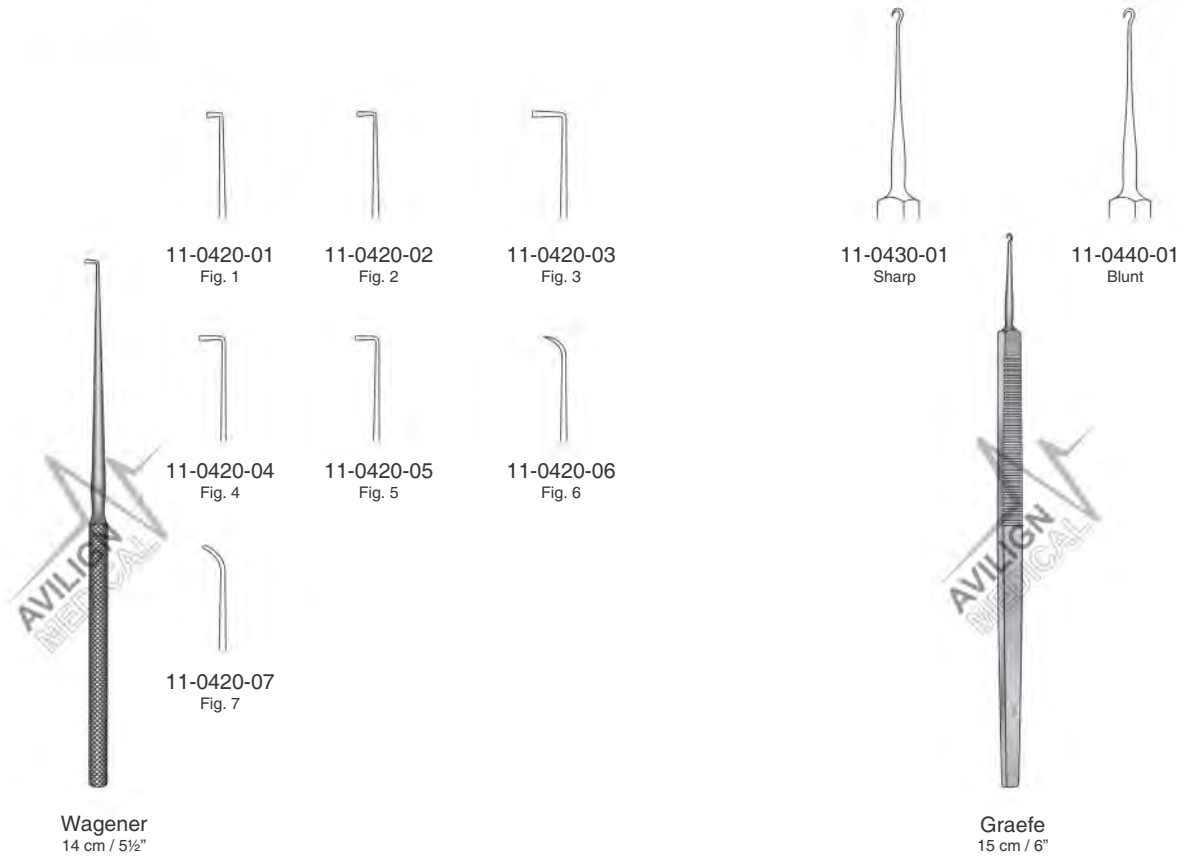



11-0480-01
 Sharp



11-0490-01
 Semi-sharp



11-0500-01
 Blunt



11-0480-02



11-0490-02



11-0500-02



11-0480-03



11-0490-03



11-0500-03

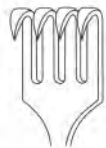

11-0480-04

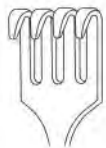

11-0490-04

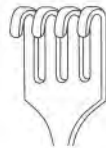

1-0500-04



Kilner
 11-0510-15
 15.5 cm / 6"
 13 x 5 mm



16.5 cm / 6½"



11-0520-01
 18 x 6 mm
 Sharp



11-0520-02
 22 x 7 mm
 Sharp



11-0520-03
 22 x 7 mm
 Blunt



Senn-Miller
 16 cm / 6¼"

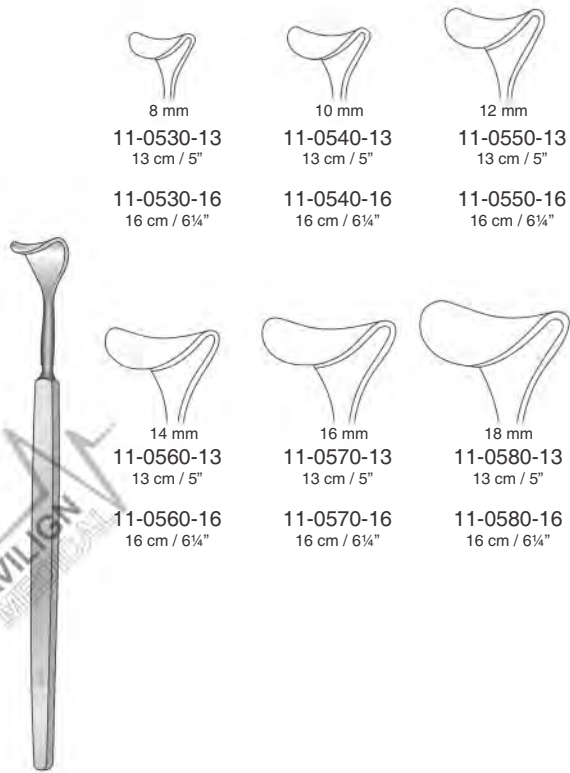

Desmarres



Cushing



Koenig
18 cm / 7"



Simon
22 cm / 8 3/4"

Lange
23 cm / 9"



Mini-Langebeck
 16 cm / 6¼"



11-0680-10
 10 x 6 mm

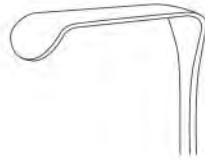

11-0680-17
 17 x 5 mm



11-0680-20
 22 x 8 mm



11-0680-22
 22 x 8 mm



11-0690-21
 11 x 12 mm



Cushing
 20 cm / 8¼"



17 cm / 6¾"



11-0700-01
 Sharp



11-0700-02



11-0700-03



11-0700-04

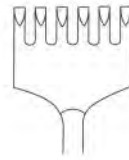

11-0700-06



11-0710-01
 Blunt



11-0710-02



11-0710-03



11-0710-04

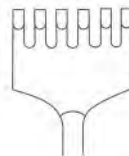

11-0710-06



11-0720-19
 28 x 6 mm



Lahey
 19 cm / 7½"



Gillies
18 cm / 7"



Joseph
16 cm / 6¼"
Sharp

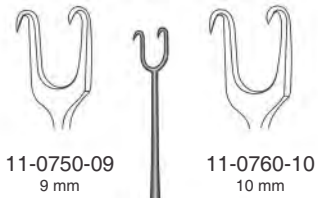
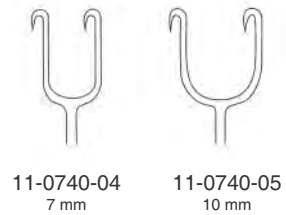
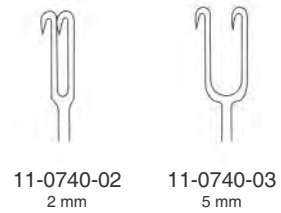

MC Indoe
15 cm / 6"



Freer
11-0770-15
15 cm / 6"



Ragnell-Davis
11-0780-14
14 cm / 5½"



Kilner
11-0790-16
16 cm / 6¼"

Wundspreizer, Selbsthaltend
 Separadores, Autoestáticos
 Divaricatori, Autostatici
 Wound Spreaders, Self Retaining

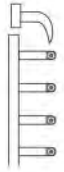

11-0800-07
7 cm / 2¾"

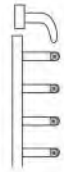

11-0810-07
7 cm / 2¾"

11-0800-10
10 cm / 4"
Sharp

11-0810-10
10 cm / 4"
Blunt



Alm

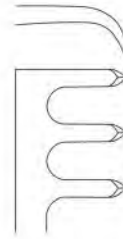

11-0820-06
Sharp

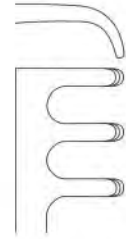

11-0830-06
Blunt



Jansen
10 cm / 4"

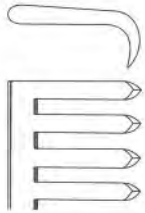

11-0840-14
Sharp

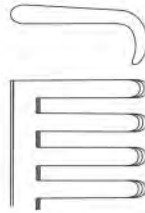

11-0850-15
Blunt

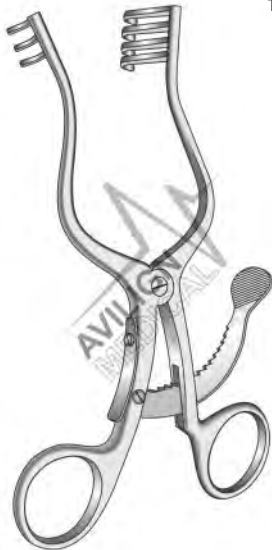

Scalp-Contour
14 cm / 5½"
3 x 4 Teeth



11-0860-10
Sharp



11-0870-10
Blunt



Weitlaner
11 cm / 5¼"
2 x 3 Teeth

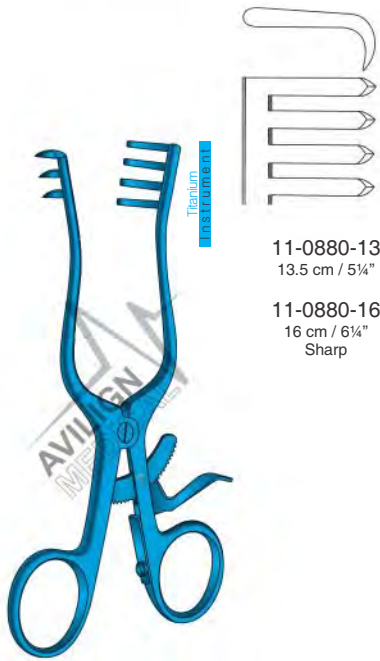

11-0880-13
13.5 cm / 5 1/4"

11-0880-16
16 cm / 6 1/4"
Sharp

Weitlaner
3 x 3 Teeth

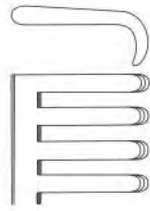

11-0890-13
13.5 cm / 5 1/4"

11-0890-16
16 cm / 6 1/4"
Blunt

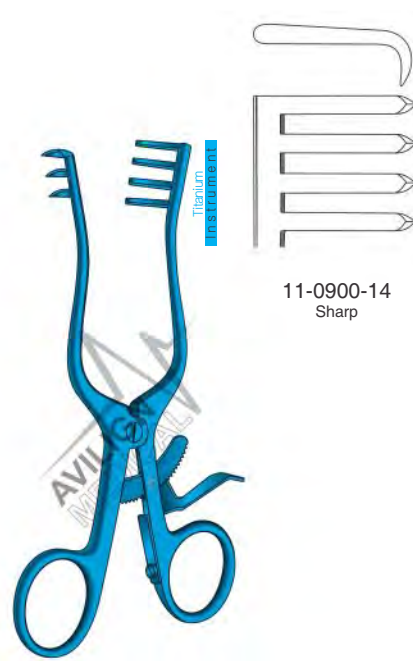

11-0900-14
Sharp

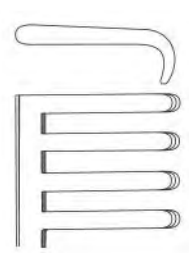

11-0910-14
Blunt

Weitlaner
13.5 cm / 5 1/4"
3 x 4 Teeth

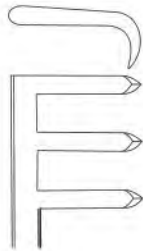

11-0920-11
11 cm / 4 1/4"

11-0920-13
13 cm / 5"
Sharp

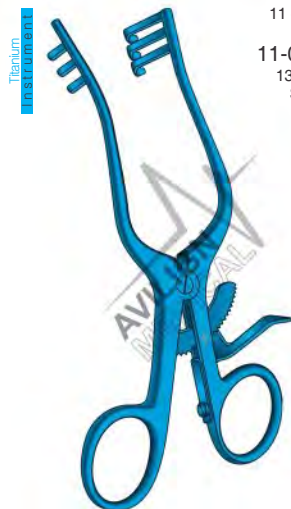

Wullstein
3 x 3 Teeth

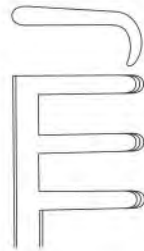

11-0930-11
11 cm / 4 1/4"

11-0930-13
13 cm / 5"
Blunt



11-0940-15
15.5 cm / 6"
Sharp

Mollison
4 x 4 Teeth

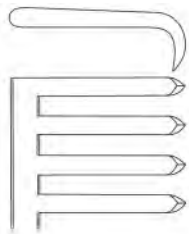

11-0950-20
 25 mm
 Sharp

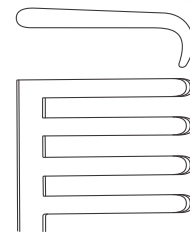

11-0960-20
 25 mm
 Blunt



Adson
 20 cm / 8"
 4 x 4 Teeth

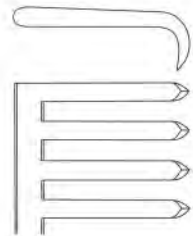

11-0970-20
 Sharp

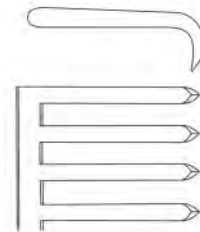

11-0990-20
 Sharp

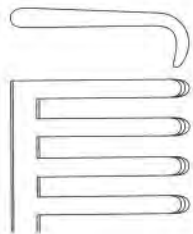

11-0980-20
 Blunt

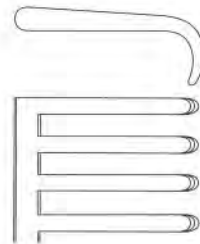

11-1000-20
 Blunt

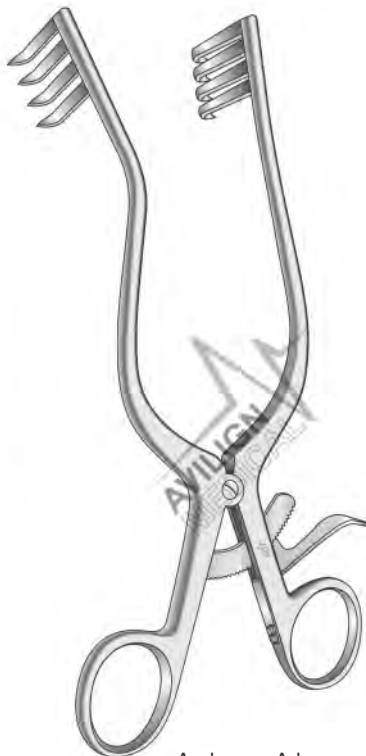

Anderson-Adson
 20 cm / 8"
 4 x 4 Teeth

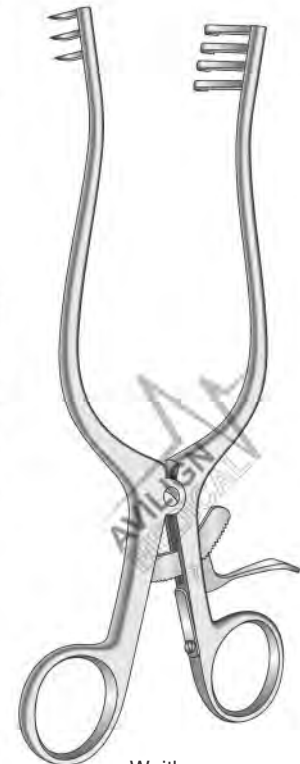

Weitlaner
 20 cm / 8"
 3 x 4 Teeth



11-1010-09
9 cm / 3½"

11-1010-11
11 cm / 4¼"



Gelpi-Loktite



1 x 1 Teeth



Gelpi-Loktite
11-1020-13
13.5 cm / 5¼"

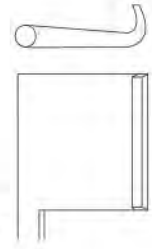

Weitlaner-Baby
11-1030-13
13.5 cm / 5¼"

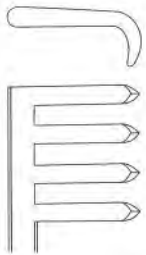

11-1040-13
13.5 cm / 5¼"

11-1040-16
16.5 cm / 6¼"
Sharp



Adson
3 x 4 Teeth

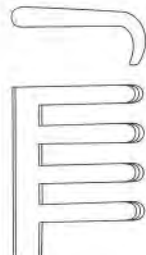

11-1050-13
13.5 cm / 5¼"

11-1050-16
16.5 cm / 6¼"
Blunt

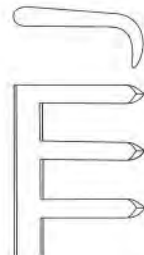

11-1060-13
Sharp



Miligan
13 cm / 5"
3 x 3 Teeth

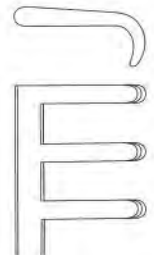

11-1070-13
Blunt

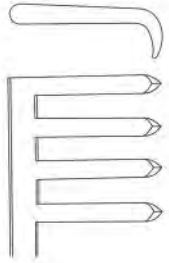

11-1080-21
 21 cm / 8¼"
 Sharp

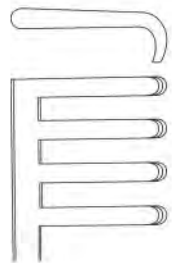

11-1090-21
 21 cm / 8¼"
 Blunt

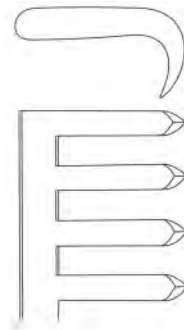

11-1120-31
 31 cm / 12¼"
 Sharp

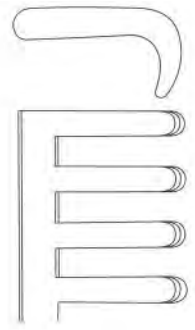

11-1130-31
 31 cm / 12¼"
 Blunt

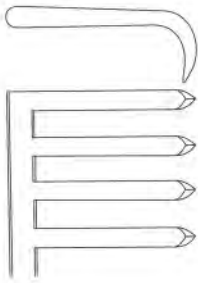

11-1100-24
 24.5 cm / 9¾"
 Sharp

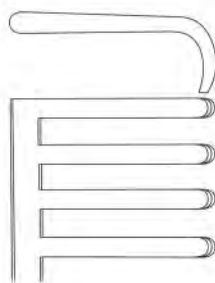

11-1110-24
 24.5 cm / 9¾"
 Blunt



Adson
 3 x 4 Teeth



Beckmann
 4 x 4 Teeth

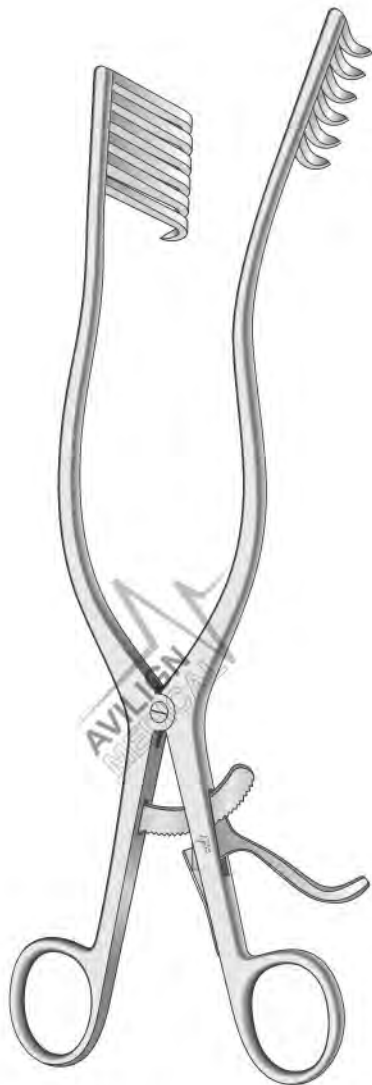

Adson
28.5 cm / 11¼"
6 x 6 Teeth

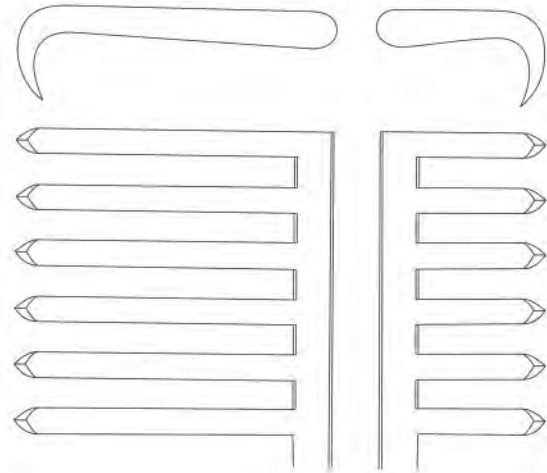

11-1140-01
Sharp

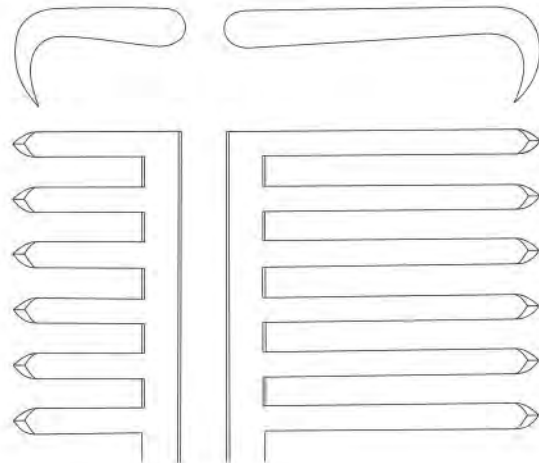

11-1150-02
Blunt

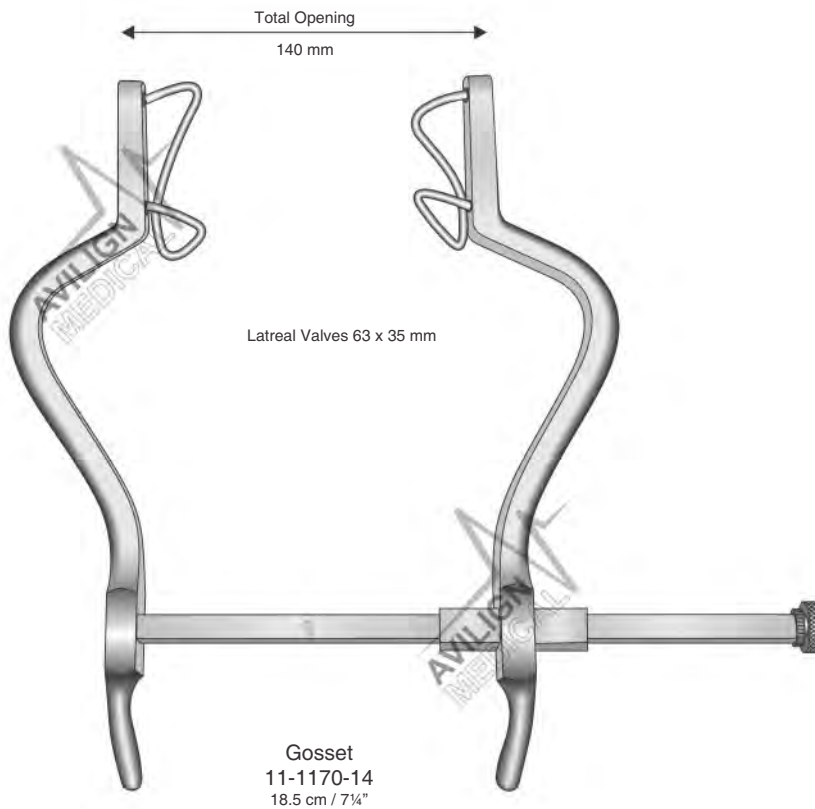
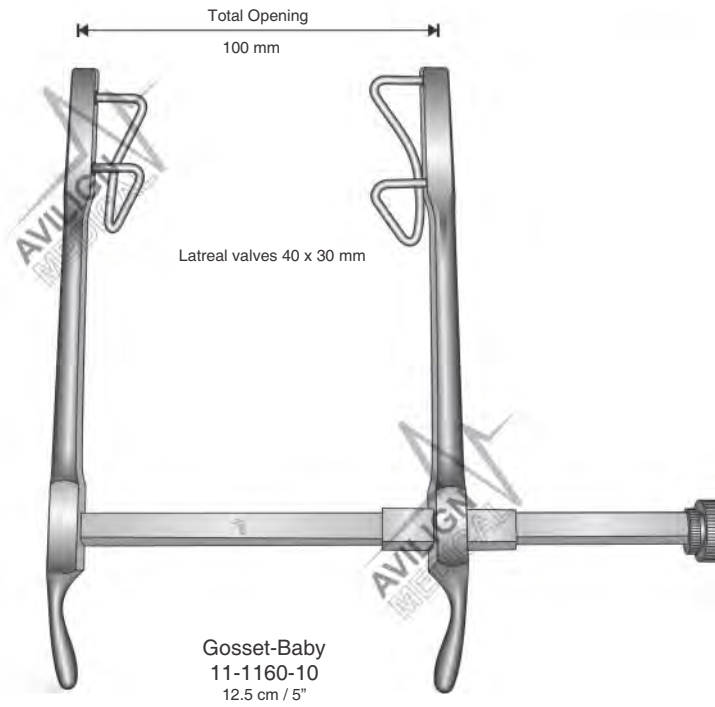

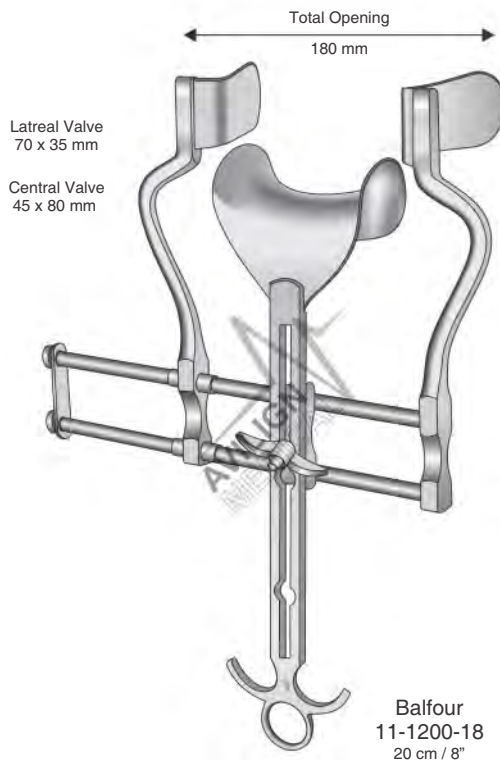
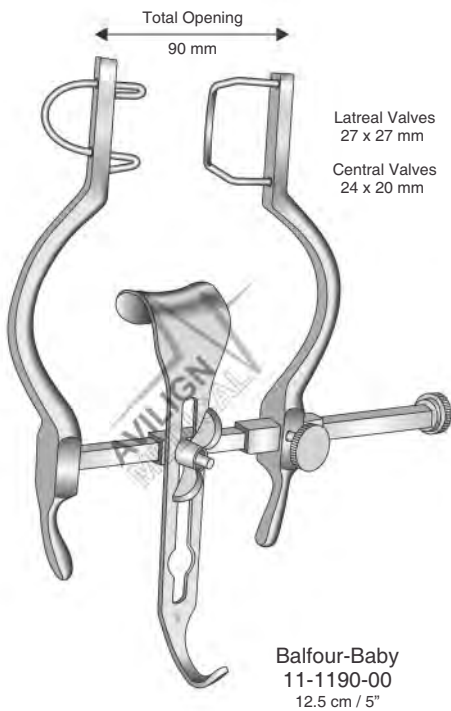
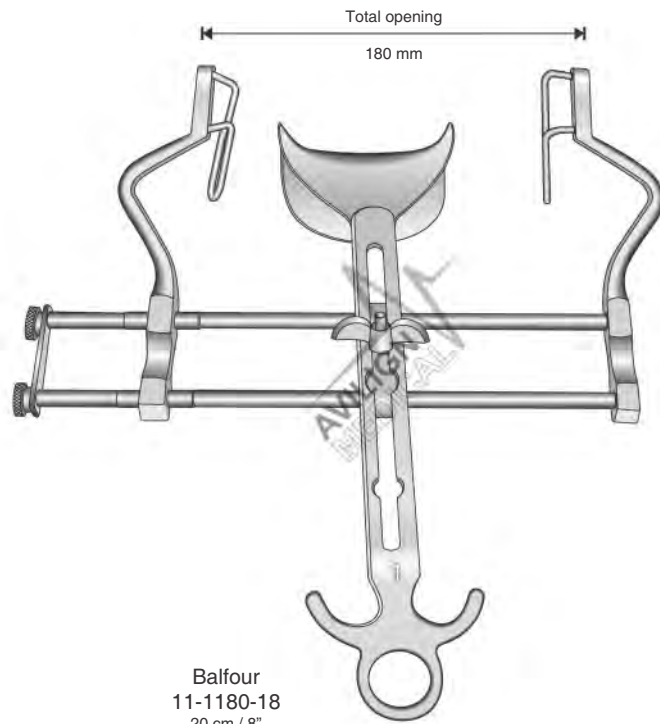



12

Needle Holders

Nadelhalter
Porta-agujas
Portaghi



12-0010-14 14 cm / 5½"
12-0010-16 16 cm / 6¼"
12-0010-18 18 cm / 7"
12-0010-20 20 cm / 8"

12-0010-24 24 cm / 9½"
12-0010-26 26 cm / 10¼"
12-0010-30 30 cm / 11¾"

Mayo-Hegar

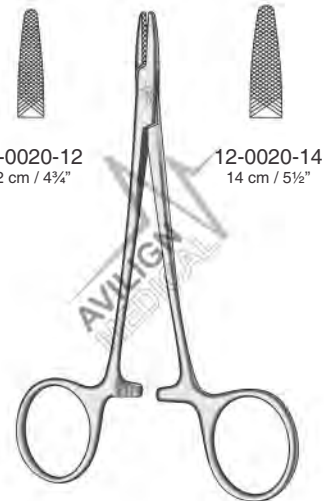

12-0020-12 12 cm / 4¾"
12-0020-14 14 cm / 5½"

Hegar-Baumgartner



12-0030-15 15 cm / 6"

Crile-Murray



12-0040-15 15 cm / 6"
12-0040-18 18 cm / 7"
12-0040-20 20 cm / 8"
12-0040-23 23 cm / 9"

Crile-Wood

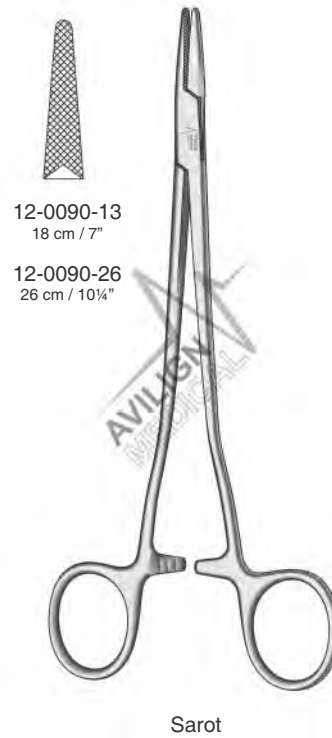
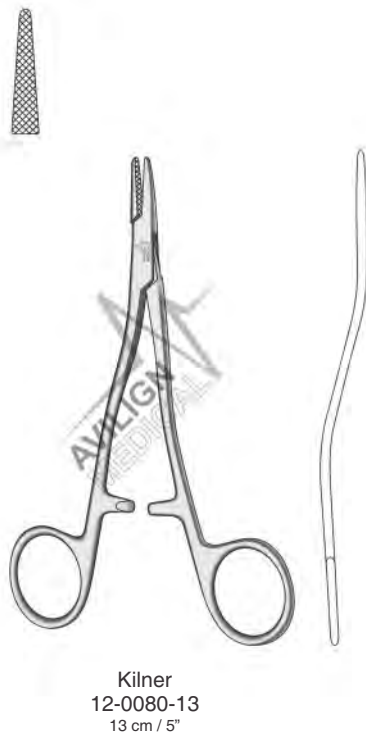



Collier
12-0100-12
12 cm / 4¾"



Derf (Wright)
12-0110-12
12 cm / 4¾"



Heaney
12-0120-21
21 cm / 8¼"



12-0130-27
27 cm / 10¾"

Masson

Nadelhalter Mit Schere
 Porta - Agujas Con Tijeras
 Portaghi Con Forbici
 Needle Holders With Scissors

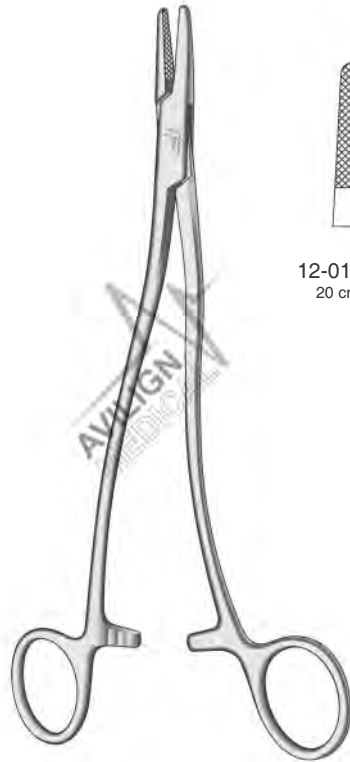

12-0140-20
 20 cm / 8"



12-0140-24
 24 cm / 9½"



12-0140-26
 26 cm / 10¼"



Bozemann
 S-Shaped

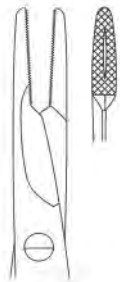

12-0150-14
 14 cm / 5½"



12-0150-18
 18 cm / 7"

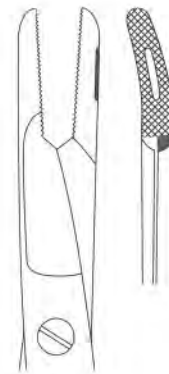

12-0160-16

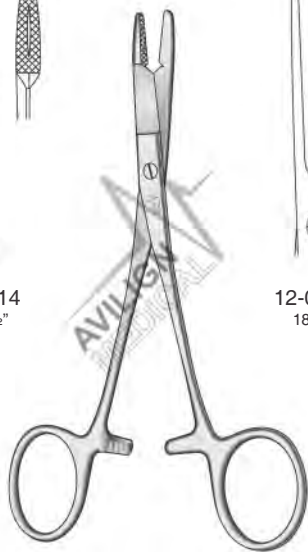

Olsen-Hegar



Gillies
 16 cm / 6¼"

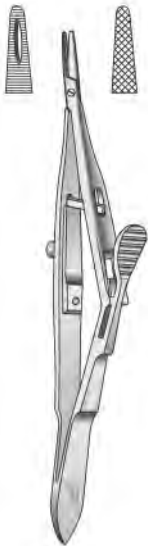

Kalt
12-0170-14
13.5 cm / 5¼"

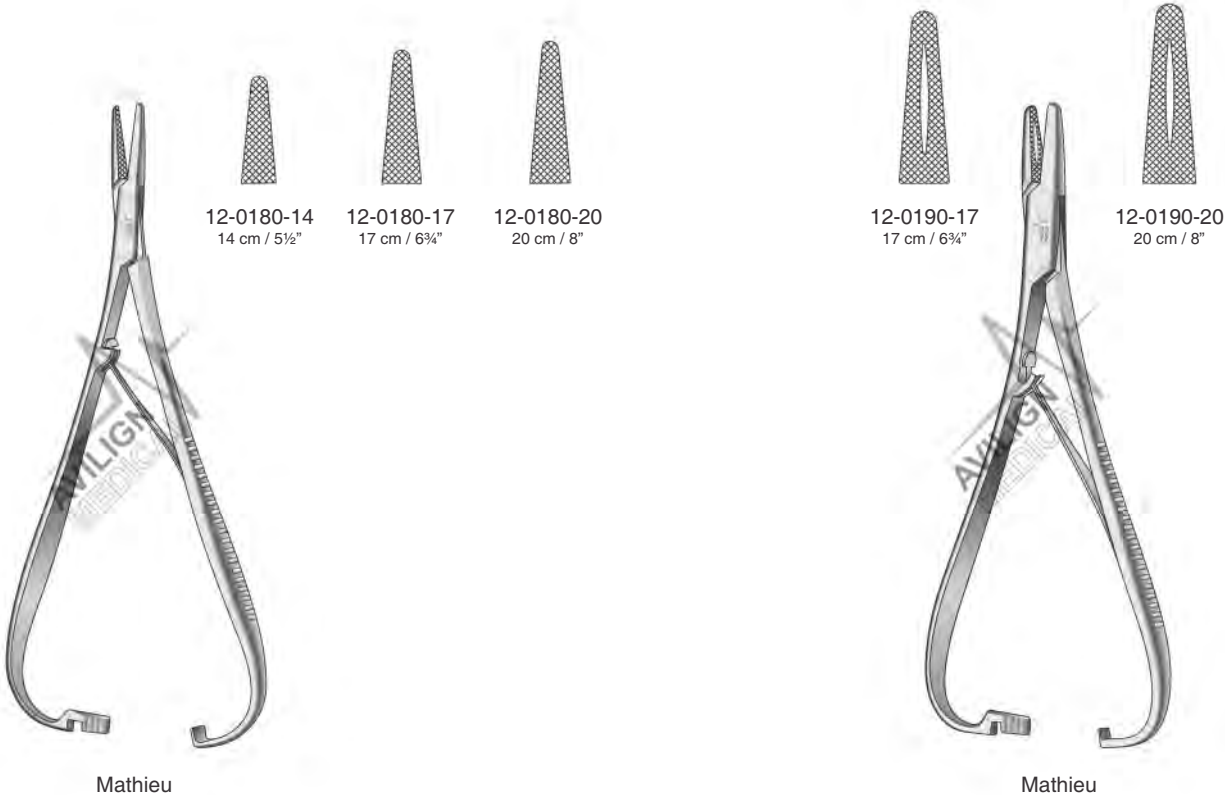

12-0180-14
14 cm / 5½"

12-0180-17
17 cm / 6¾"

12-0180-20
20 cm / 8"

12-0190-17
17 cm / 6¾"

12-0190-20
20 cm / 8"

Mathieu

Mathieu

Nadelhalter
 Porta-agujas
 Portaghi
 Needle Holders



12-0200-20
20 cm / 8"
 12-0200-27
27 cm / 10¾"

Finochietto



12-0210-13 13 cm / 5"
 12-0210-15 15 cm / 6"
 12-0210-18 18 cm / 7"
 12-0210-20 20 cm / 8"
 12-0210-23 23 cm / 9"

Vascular



12-0220-13 13 cm / 5"
 12-0220-15 15 cm / 6"
 12-0220-18 18 cm / 7"
 12-0220-20 20 cm / 8"
 12-0220-23 23 cm / 9"

Vascular



12-0230-13 13 cm / 5"
 12-0230-15 15 cm / 6"
 12-0230-16 15 cm / 6¼"
 12-0230-18 18 cm / 7"
 12-0230-20 20 cm / 8"
 12-0230-23 23 cm / 9"

Ryder



Reverdin

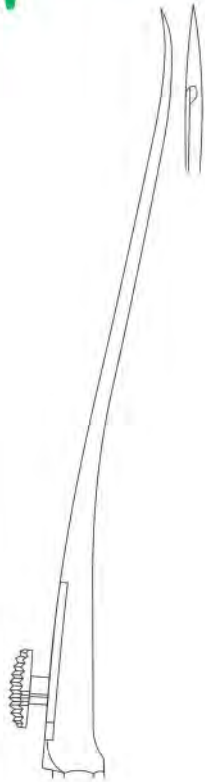

12-0240-19 19 cm / 7½"
12-0240-21 21 cm / 8¼"
12-0240-23 23 cm / 9"



12-0250-19 19 cm / 7½"
12-0250-21 21 cm / 8¼"
12-0250-23 23 cm / 9"



12-0260-19 19 cm / 7½"
12-0260-21 21 cm / 8¼"
12-0260-23 23 cm / 9"



12-0270-19 19 cm / 7½"
12-0270-21 21 cm / 8¼"
12-0270-23 23 cm / 9"



Reverdin
15 cm / 6"



12-0280-15



12-0290-15

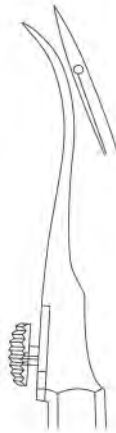

12-0300-15



12-0310-15



12-0320-21
24 cm / 9½"



Schmieden

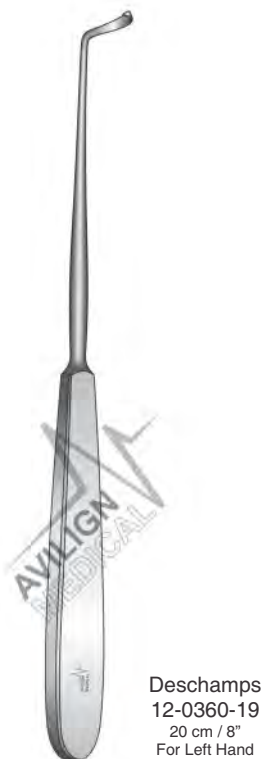
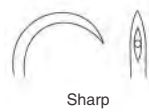
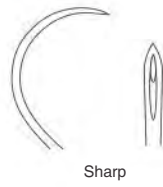
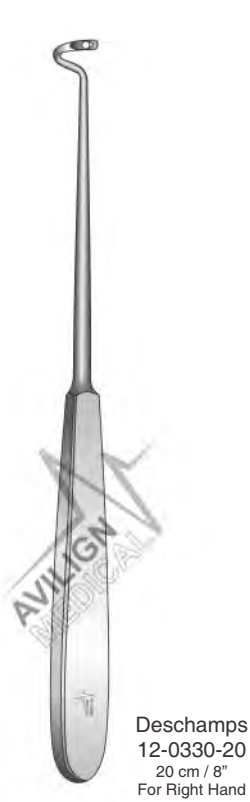



Michel
12-0370-12
12.5 cm / 5"



Michel
12-0380-12
12 cm / 4¾"



Wachenfeldt
12-0390-12
12.5 cm / 5"



Hegenbarth
12-0400-12
12 cm / 4¾"

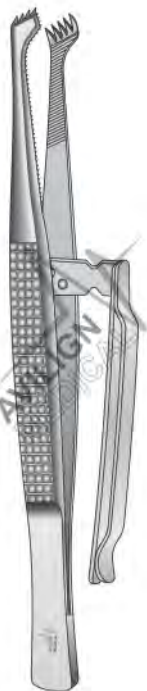

Childe
12-0410-18
18 cm / 7"

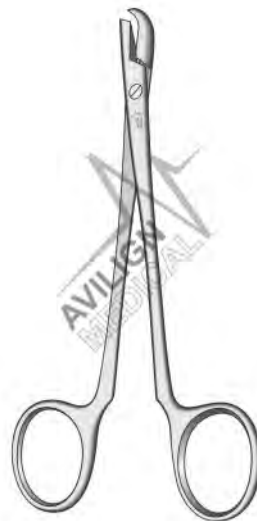

Collin
12-0420-13
13.5 cm / 5¼"



Richter-Heath
12-0430-14
13.5 cm / 5¼"



13

TC Needle Holders

Nadelhalter mit Hartmetalleinlagen

Porta-agujas con bocas de carburo tungsteno

Portaghi con morsi in carburo di tungsteno



Mayo-Hegar



13-0010-14
14 cm / 5½"



13-0010-16
16 cm / 6¼"



13-0010-18
18 cm / 7"



13-0010-20
20 cm / 8"



13-0010-24
24 cm / 9½"



13-0010-26
26 cm / 10¼"



13-0010-30
30 cm / 11¾"



13-0010-36
36 cm / 14"



13-0010-40
40 cm / 16"



De Bakey



13-0020-15
15 cm / 6"



13-0020-16
16 cm / 6¼"



13-0020-18
18 cm / 7"



13-0020-20
20 cm / 8"



13-0020-23
23 cm / 9"



13-0020-26
26 cm / 10¼"



13-0020-31
31 cm / 12½"



13-0020-37
37 cm / 14½"

Nadelhalter Mit Hartmetalleinlagen
 Porta-agujas Con Bocas De Carburo Tungsteno
 Portaghi Con Morsi In Carburo Di Tungsteno
 Tungsten Carbide Needle Holders

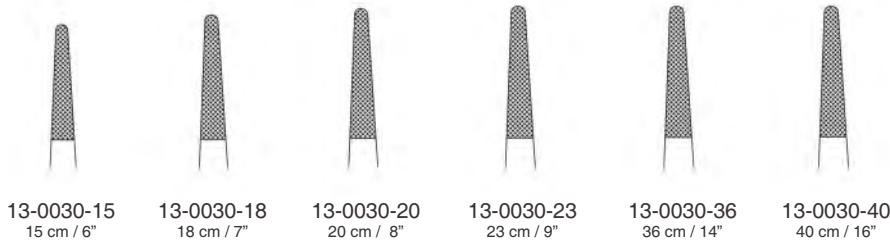

Crile-wood

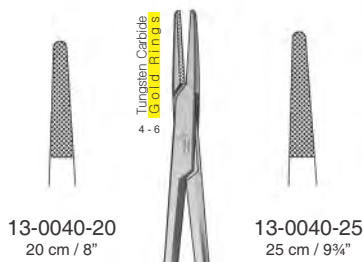

De Bakey



Baby-Crile-Wood



Senning

13-0060-15
15 cm / 6"

13-0060-17
17 cm / 6¾"

13-0060-20
20 cm / 8"

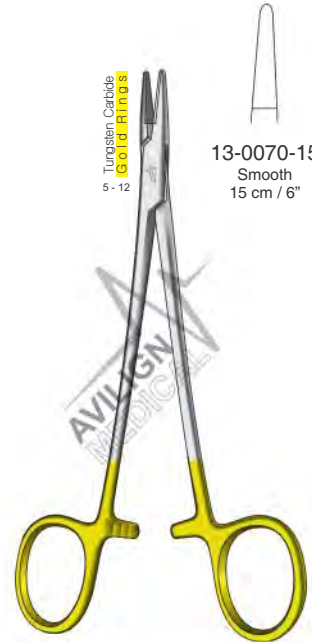

Crile-Wood

13-0070-15
Smooth
15 cm / 6"



Sarot

13-0080-18
18 cm / 7"

13-0080-20
20 cm / 8"

13-0080-26
26 cm / 10¼"



Hegar-Baumgartner

13-0090-13 13 cm / 5"
13-0090-14 14 cm / 5½"

Nadelhalter Mit Hartmetalleinlagen
 Porta - Agujas Con Bocas De Carburo Tungsteno
 Portaghi Con Morsi In Carburo Di Tungsteno
 Tungsten Carbide Needle Holders

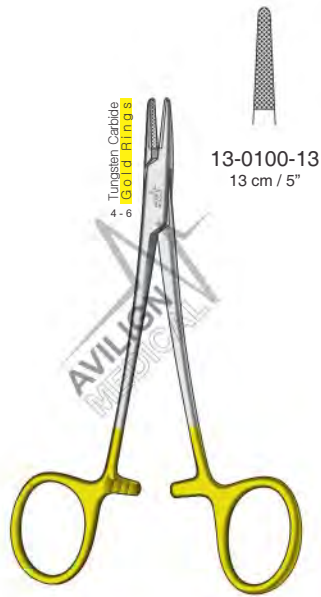

Neivert-Masing

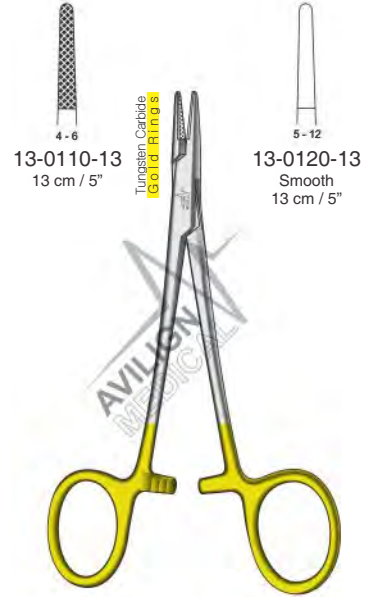

Halsey



Webster

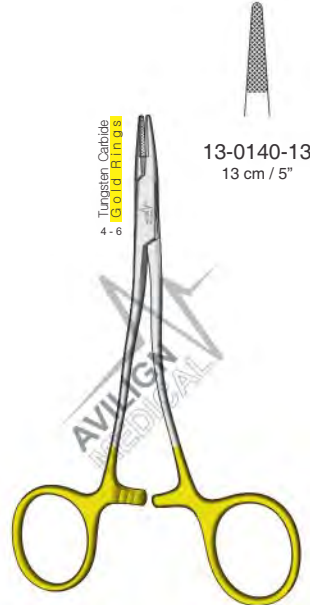

Kilner



Derf



Tungsten Carbide
Gold Rings
 0.6 - 4



Hegar



Tungsten Carbide
Gold Rings
 0.6 - 4



- 13-0170-20 20 cm / 8"
- 13-0170-24 24 cm / 9½"
- 13-0170-26 26 cm / 10¼"
- 13-0170-36 36 cm / 14¼"

Heaney

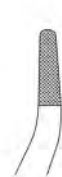

13-0180-22
 22 cm / 8"



13-0180-23
 23 cm / 9"



Tungsten Carbide
Gold Rings
 0.6 - 4

Stratte

Nadelhalter Mit Hartmetalleinlagen
 Porta-Agujas Con Bocas De Carburo Tungsteno
 Portaghi Con Morsi In Carburo Di Tungsteno
 Tungsten Carbide Needle Holders





Micro-Vascular

13-0220-14
14 cm / 5½"

13-0220-18
18 cm / 7"

13-0220-20
20 cm / 8"

13-0220-23
23 cm / 9"

13-0230-13
smooth



Olsen-Hegar
13 cm / 5"

13-0240-13



Gillies

13-0250-16
16 cm / 6¼"

Nadelhalter Mit Hartmetalleinlagen
Porta- Aguja Con Bocas De Carburo Tungsteno
Portaghi Con Morsi In Carburo Di Tungsteno
Tungsten Carbide Needle Holders



13-0260-14
14 cm / 5½"



13-0260-17
17 cm / 6¾"



13-0260-20
20 cm / 8"



Mathieu



13-0270-14
14 cm / 5½"



13-0270-17
17 cm / 6¾"



13-0270-20
20 cm / 8"



Mathieu



Ryder-Vascular



13-0280-13
13 cm / 5"



13-0280-15
15 cm / 6"



13-0280-18
18 cm / 7"



13-0280-20
20 cm / 8"



13-0280-23
23 cm / 9"



13-0280-26
26 cm / 10½"



13-0290-13
13 cm / 5"



13-0290-15
15 cm / 6"



13-0290-18
18 cm / 7"



13-0300-14
14 cm / 5½"



13-0300-16
16 cm / 6¼"



Micro-Ryder



13-0290-20
20 cm / 8"



13-0290-23
23 cm / 9"



13-0290-26
26 cm / 10½"



13-0300-18
18 cm / 7"



13-0300-20
20 cm / 8"

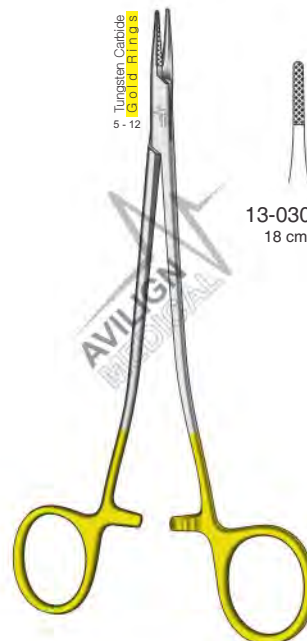

Hegar-Vascular



14

ENT Instruments

HNO-Instruments
Instrumentos para ORL
Strumenti per ORL

16 mm



16 mm

14-0010-14
14.5 cm / 5¾"

14 mm



18 mm

Bruenings
14-0020-19
19 cm / 7½"

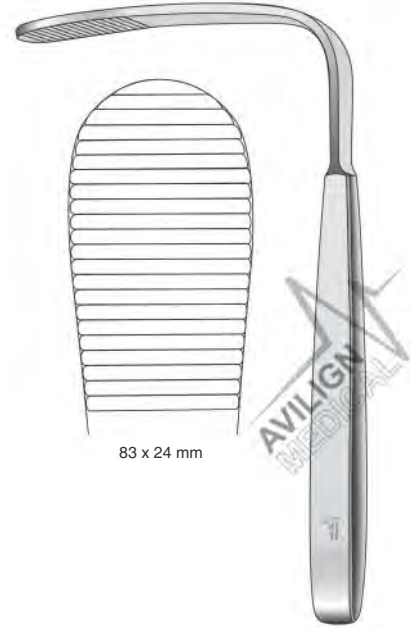

83 x 24 mm

Tobold
14-0030-14
14 cm / 5½"



Moritz-Schmidt
14-0040-19
19 cm / 7½"



72 x 23 mm



Hartmann
14-0050-15
15 cm / 6"



Wieder
 14.5 cm / 5¾"

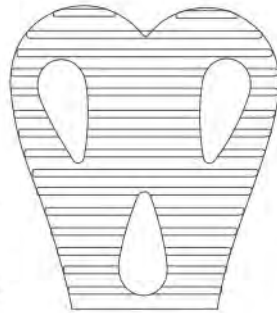

14-0060-01
 30 x 90 mm

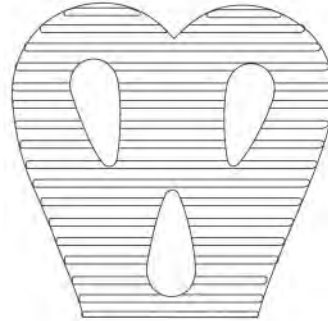

14-0060-02
 35 x 90 mm



Doyen



22 mm



30 mm

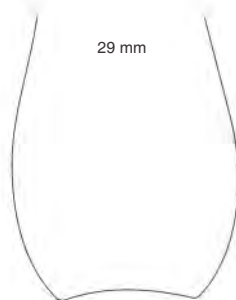

29 mm



33 mm

14-0070-13
 13 cm / 5"

14-0070-16
 16 cm / 6¼"



Heister
14-0080-13
13 cm / 5"



Molt
14-0090-10
10 cm / 4"

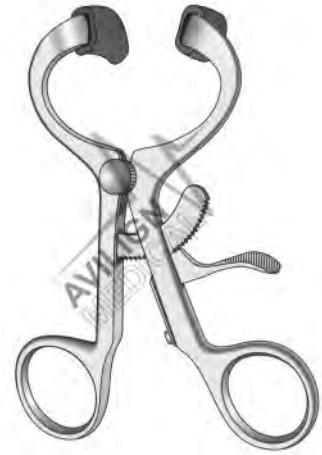

Doyen-Collin
14-0100-13
12 cm / 4¾"



Doyen-Jansen
14-0110-14
14 cm / 5½"



Fergusson-Ackland
14-0120-14
14.5 cm / 5¾"

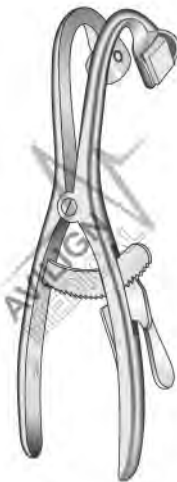

Denhardt
14-0130-12
12.5 cm / 5"

14-0130-99
spare jaws

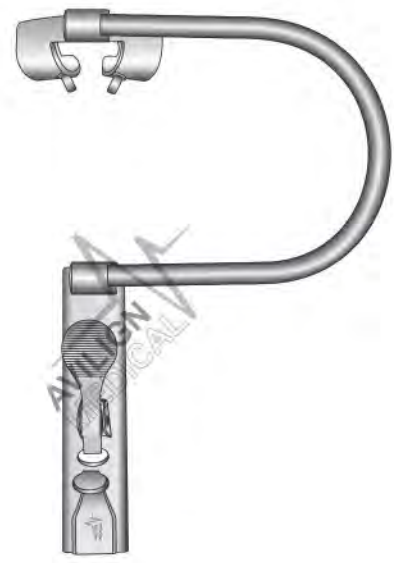

Davis-Boyle
 14-0140-90 Set
 14-0140-00 1 Frame



Tounge Depressor
 14-0140-01
 25 x 19 mm
 Fig. 1

Tounge Depressor
 14-0140-02
 62 x 25 mm
 Fig. 2

Tounge Depressor
 14-0140-03
 75 x 25 mm
 Fig. 3

Tounge Depressor
 14-0140-04
 92 x 25 mm
 Fig. 4

Tounge Depressor
 14-0140-05
 108 x 25 mm
 Fig. 5



Davis-Boyle
14-0150-90 Set
14-0150-00 1 Frame



Tounge Depressor
14-0150-01
25 x 19 mm
Fig. 1



Tounge Depressor
14-0150-02
62 x 25 mm
Fig. 2



Tounge Depressor
14-0150-03
75 x 25 mm
Fig. 3



Tounge Depressor
14-0150-04
92 x 25 mm
Fig. 4



Tounge Depressor
14-0150-05
108 x 25 mm
Fig. 5



Mc Ivor
14-0160-90 Set
14-0160-00 1 Frame



Tounge Depressor
14-0160-01
70 x 23 mm
Fig. 1



Tounge Depressor
14-0160-02
86 x 25 mm
Fig. 2



Tounge Depressor
14-0160-03
100 x 26 mm
Fig. 3

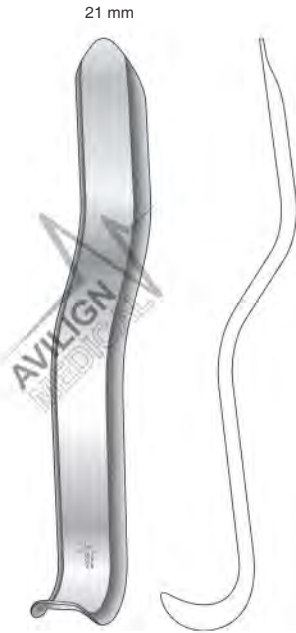

Cawood-Minnesota
 14-0170-15
 15 cm / 6"



Collin
 14-0180-16 16 cm / 6¼"
 14-0180-18 18 cm / 7"

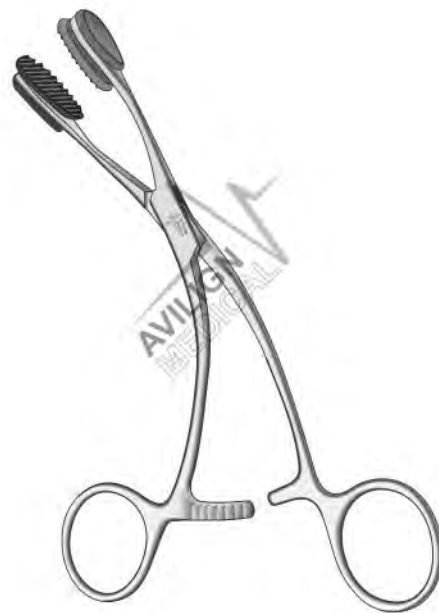

Young
 14-0190-16
 16 cm / 6¼"

Tonsillendissektoren
 Disectores Para Amígdalas
 Dissettori Per Tonsille
 Tonsil Dissectores

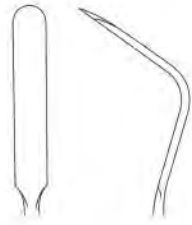

14-0200-01
 25 cm / 9 3/4"



Carpenter
 Tonsil Knife & Enucleator

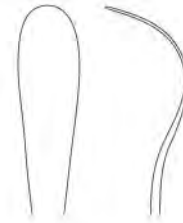

14-0210-02
 24 cm / 9 1/2"



Carpenter

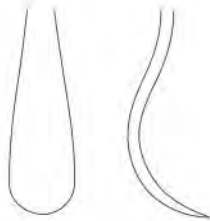

12 mm



14 mm



14 mm

14-0220-01

14-0220-02

14-0220-03

6 mm



10 mm



9 mm



Hurd
 21.5 cm / 8 1/2"



12 mm



17 mm

14-0230-01

14-0230-02



Henke
 23.5 cm / 9 1/4"



14-0240-21
 21 cm / 8¼"
 For Left Hand

Hurd
 Cleft Palate Needle



14-0250-21
 21 cm / 8¼"
 For Right Hand

Hurd
 Cleft Palate Needle



Fischer
 14-0260-20
 20.5 cm / 8"



Eves
 14-0270-26
 28 cm / 11"
 Without Ratchet

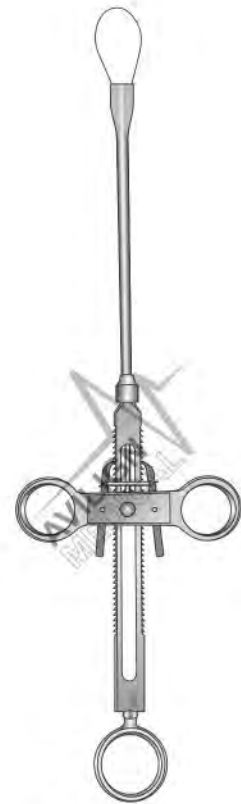

Bruenings
 14-0280-27
 27 cm / 10¾"
 With Ratchet

Ringmesser
Cuchillos Para Adenoides
Coltelli Per Vegetazioni Adenoidee
Adenoid Currettes



14-0290-01
Fig. 1



14-0290-02
Fig. 2



14-0290-03
Fig. 3



14-0290-04
Fig. 4



14-0290-05
Fig. 5



14-0290-06
Fig. 6



Beckmann
22.5 cm / 9"



14-0300-01
Fig. 1



14-0300-02
Fig. 2



14-0300-03
Fig. 3



14-0300-04
Fig. 4



14-0300-05
Fig. 5



14-0300-06
Fig. 6



Beckmann
22.5 cm / 9"

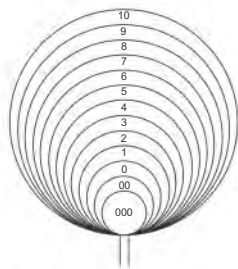

- 14-0310-06 06 mm, Fig. 000
- 14-0310-08 08 mm, Fig. 00
- 14-0310-10 10 mm, Fig. 0
- 14-0310-12 12 mm, Fig. 1
- 14-0310-14 14 mm, Fig. 2
- 14-0310-16 16 mm, Fig. 3
- 14-0310-18 18 mm, Fig. 4
- 14-0310-20 20 mm, Fig. 5
- 14-0310-22 22 mm, Fig. 6
- 14-0310-24 24 mm, Fig. 7
- 14-0310-26 26 mm, Fig. 8
- 14-0310-28 28 mm, Fig. 8
- 14-0310-30 30 mm, Fig. 10



Laryngeal Mirrors
14 cm / 5½"
Without Handle

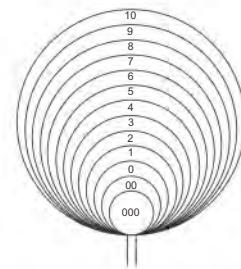

- 14-0320-06 06 mm, Fig. 000
- 14-0320-08 08 mm, Fig. 00
- 14-0320-10 10 mm, Fig. 0
- 14-0320-12 12 mm, Fig. 1
- 14-0320-14 14 mm, Fig. 2
- 14-0320-16 16 mm, Fig. 3
- 14-0320-18 18 mm, Fig. 4
- 14-0320-20 20 mm, Fig. 5
- 14-0320-22 22 mm, Fig. 6
- 14-0320-24 24 mm, Fig. 7
- 14-0320-26 26 mm, Fig. 8
- 14-0320-28 28 mm, Fig. 8
- 14-0320-30 30 mm, Fig. 10



Laryngeal Mirrors
19 cm / 7½"
With Fixed Handle

Tracheotomie, kropffasszangen, Muskelklemmen
 Traqueotomía, Pinze De Sugestión Para Bocio, Pinza-clamp Para Músculos
 Tracheotomia, Pinze Da Presa Per Gozzo, Pinza Muscolare
 Tracheotomy, Goitre Grasping Forceps, Muscular Clamp



Lukens
 14-0330-17
 17 cm / 6 3/4"
 Tracheal Retractors



News
 14-0340-15
 15 cm / 6"
 Tracheal Retractors



Trousseau
 14-0350-12
 14 cm / 5 1/2"
 Tracheal Dilator



Lahey
 14-0360-15 15 cm / 6"
 14-0360-20 20 cm / 8"
 Goitre Grasping Forceps



Face-Lift
 14-0370-18
 18 cm / 7"



14-0380-01
Fig. 1



14-0380-02
Fig. 2



14-0380-03
Fig. 3



14-0380-04
Fig. 4

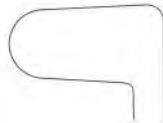

14-0380-05
Fig. 5

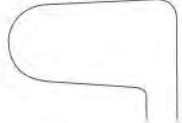

14-0380-06
Fig. 6



Thudichum
6.5 cm / 2½"
Self-Retaining

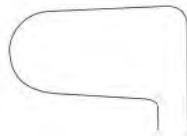

14-0380-07
Fig. 7

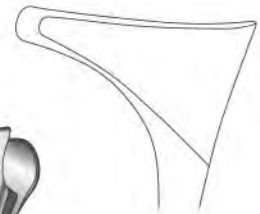

14-390-15
15 cm / 6"



Beckmann
With Screw Joint



14-0400-01
Fig. 1
For Infants

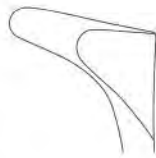

14-0400-02
Fig. 2
For Babies



Tieck-Halle
13.5 cm / 5¼"
With Aseptic Joint (dismantable)



14-0410-13
Fig. 2
For Babies



Tieck-Halle
13.5 cm / 5¼"
With aseptic joint (dismantable)

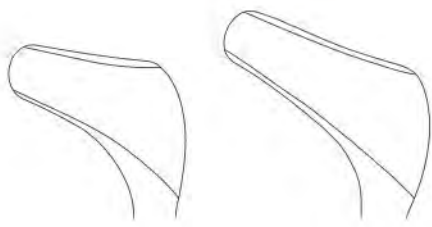

14-0420-01
 Fig. 1



14-0420-02
 Fig. 2

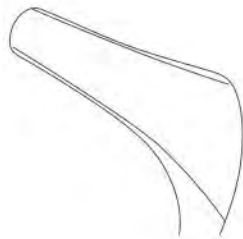

14-0420-03
 Fig. 3



Hartmann-Halle
 15.5 cm / 6"
 With Aseptic Joint (Dismantable)

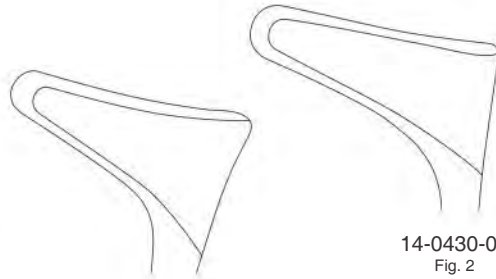

14-0430-01
 Fig. 1

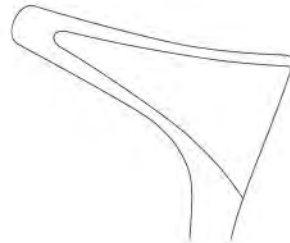

14-0430-02
 Fig. 2

14-0430-03
 Fig. 3



Hartmann
 16 cm / 6¼"
 With Screw Joint

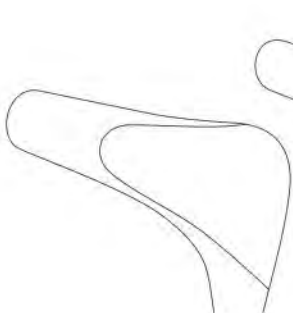

14-0440-01
 40 mm

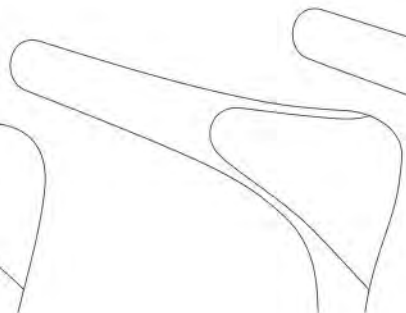

14-0440-02
 55 mm

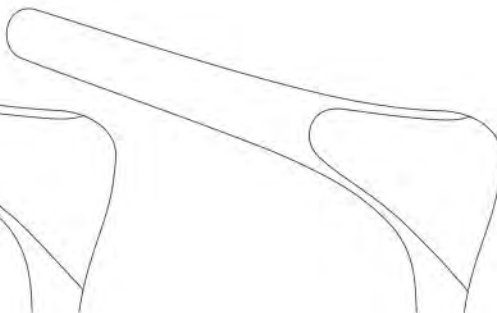

14-0440-03
 65 mm

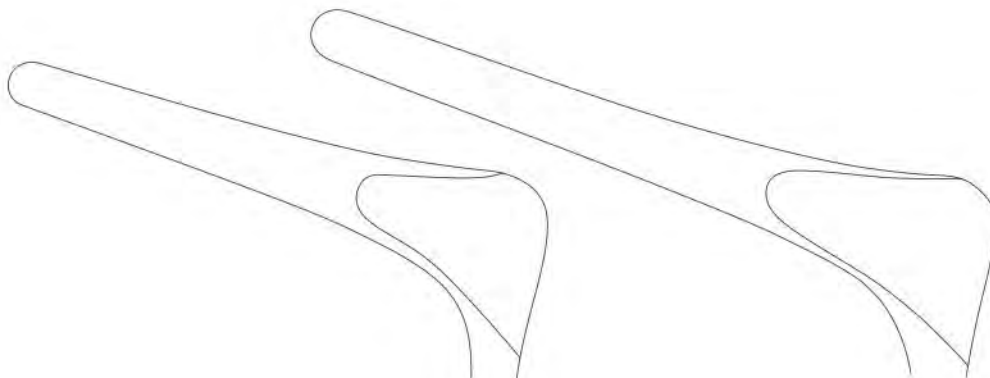

14-0440-04
 75 mm

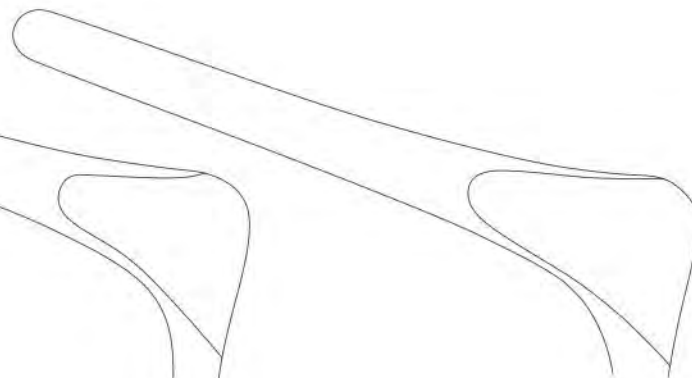

14-0440-05
 90 mm



Killian
 14 cm / 5½"
 With Aseptic Joint (Dismantable)



Tilley
14-0450-13
14 cm / 5½"

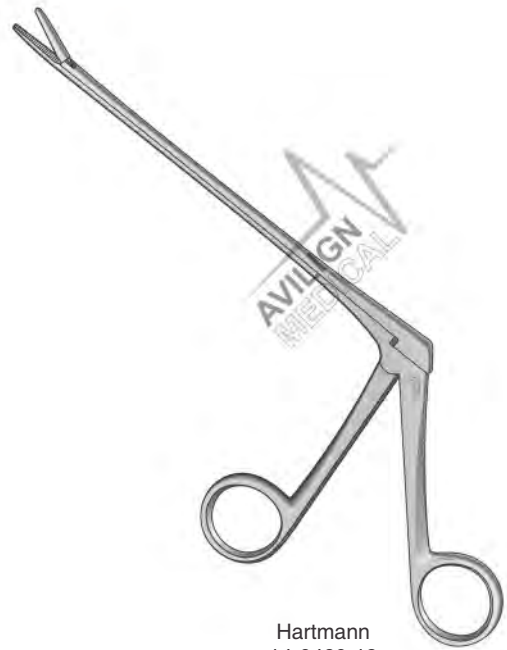

Hartmann
14-0460-19
19 cm / 7½"



Littauer
14-0470-18
18 cm / 7"



Westmacott
14-0480-20
20 cm / 8"



Hartmann
14-0490-20
20 cm / 8"

Rhinoplastik - Messer, Septumelevatoren
 Cuchillos Para Rinoplástica, Elevadores Para Tabique Nasal
 Bisturi Per Plastica Nasale, Elevatori Per Il Nasale
 Rhinoplastic - Knives, Septum Elevators

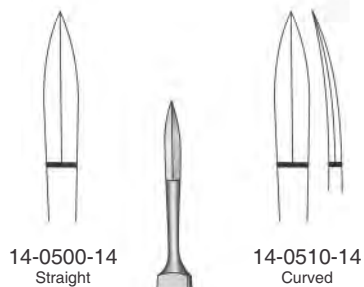

Joseph
 14.5 cm / 5¾"
 Rhinoplastic-knives



Freer
 Mucosa Knife



Freer-Yasargil
 14-0530-19
 18.5 cm / 7¼"
 Sharp



Freer-Joseph
 14-0540-21
 20 cm / 8"



Freer
 14-0550-19
 19 cm / 7½"



14-0560-17
17 cm / 6 3/4"



Mc Kenty
15 cm / 6"

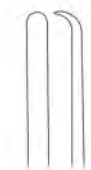

14-0570-03
3 mm

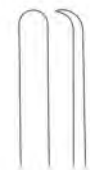

14-0570-04
4 mm

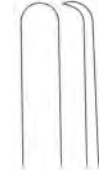

14-0570-05
5 mm



Killian
18 cm / 7"

14-0580-18

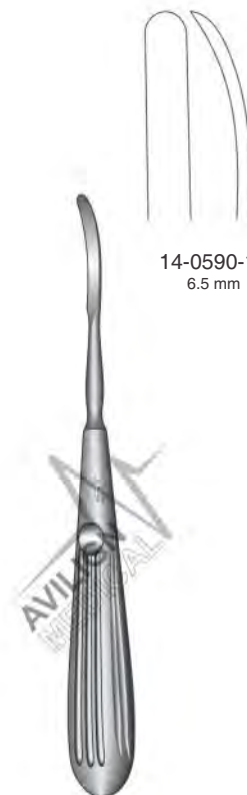

Joseph
16 cm / 6 1/4"

14-0590-16
6.5 mm

Septum elevatori, Nasensagen, , Schwingmesser
 Elevadores Para Tabique Nasal, Sierras Nasales
 Elevatori Per il Setto Nasale, Seghe Nasali
 Septum Elevators, Nasal Saws, , Swivel Knives

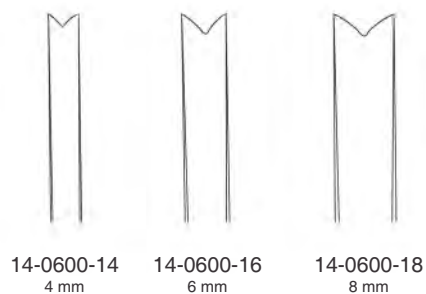

14-0600-14 4 mm
 14-0600-16 6 mm
 14-0600-18 8 mm

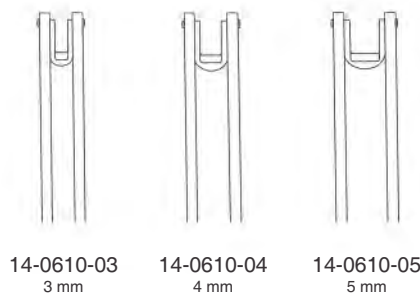

14-0610-03 3 mm
 14-0610-04 4 mm
 14-0610-05 5 mm



Ballenger
 15.5 cm / 6"

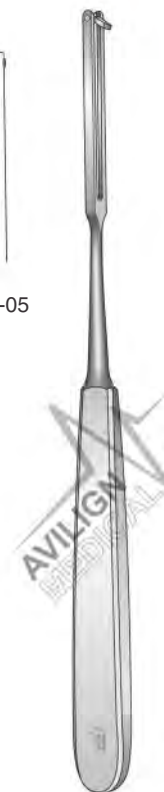

Ballenger
 21 cm / 8 1/4"



14-0620-22
 21.5 cm / 8 1/2"

Howarth

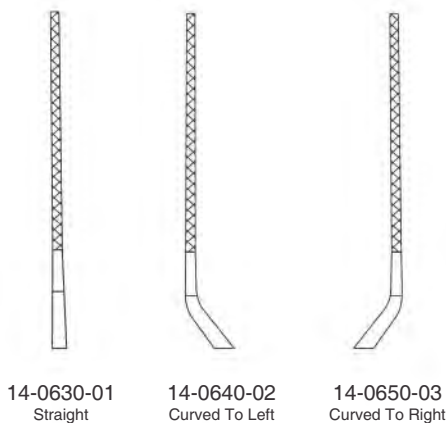

14-0630-01 Straight
 14-0640-02 Curved To Left
 14-0650-03 Curved To Right



Joseph
 19 cm / 7 1/2"

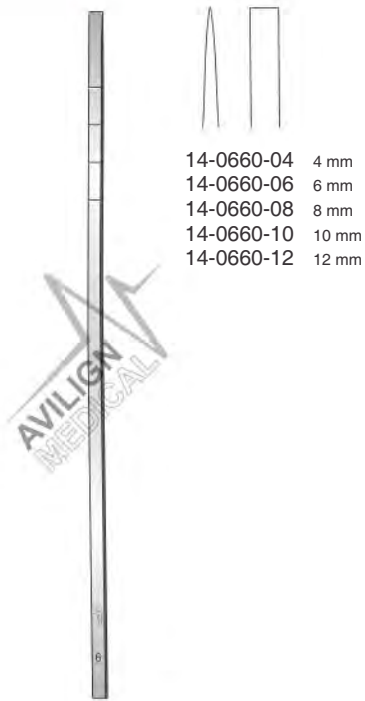

Cottle
Graduated Osteotomes
18 cm / 7"
Straight

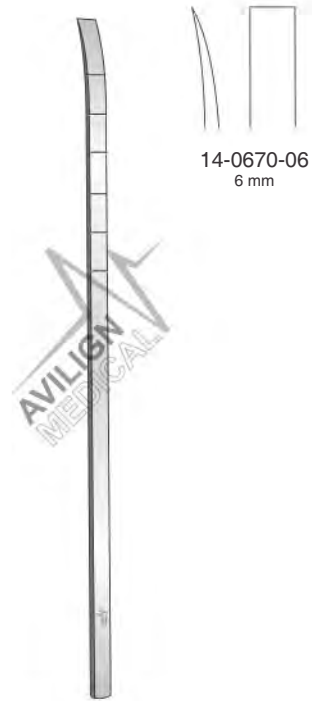

Cottle
Graduated Osteotomes
18 cm / 7"
Curved

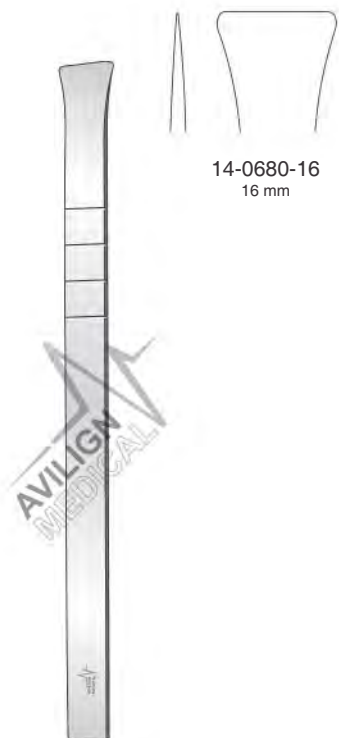

Cottle
Graduated Osteotomes
18 cm / 7"

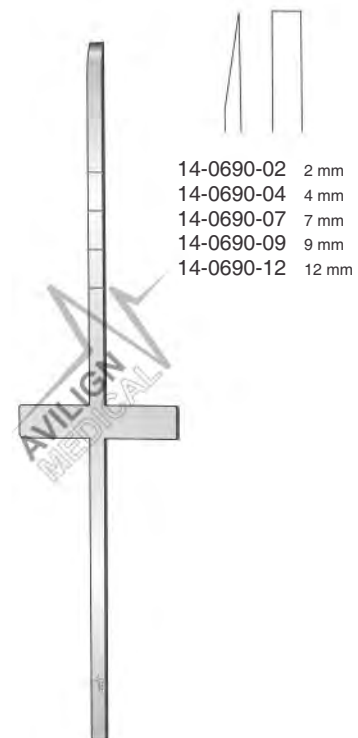

Cottle
Graduated Chisels
18.5 cm / 7¼"

Nasenhaken, Nasenflügelhäkchen
 Separadores Nasaes, Ganchito Para Alas De Nariz
 Divaricatori Nasali, Uncino Per Ali Nasali
 Nasal Retractors, Alar Nasal Hooklets

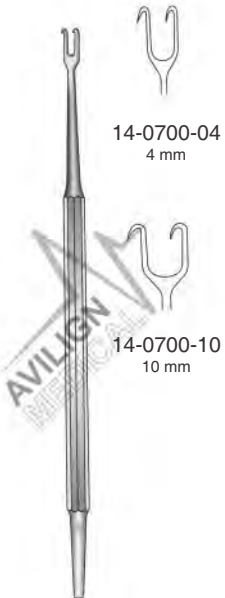

14-0700-04
 4 mm

14-0700-10
 10 mm

Cottle
 15 cm / 6"
 Sharp



14-0710-01
 Sharp / Sharp



14-0710-02
 Blunt / Sharp

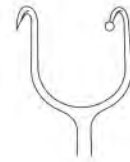

14-0710-03
 Sharp / Blunt



Cottle
 14.5 cm / 5¾"



14-0720-16
 Blunt / Blunt



Fomon
 16 cm / 6¼"



14-0730-20



Cottle-Neivert
 20 cm / 8"

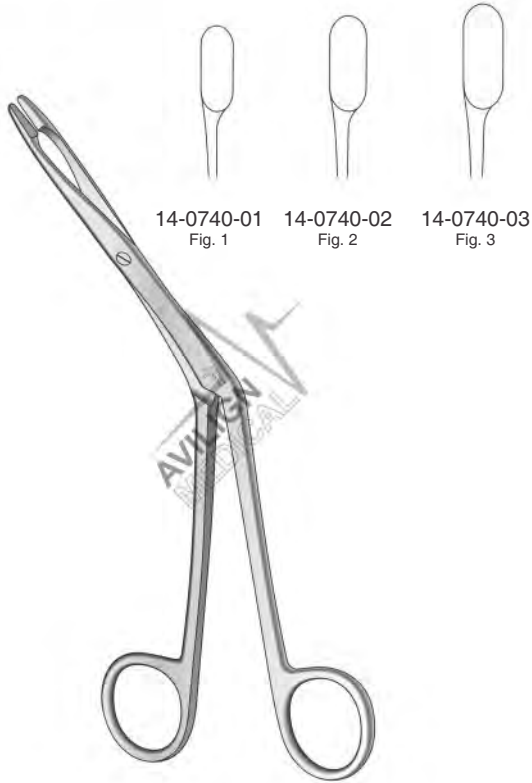

14-0740-01 Fig. 1
14-0740-02 Fig. 2
14-0740-03 Fig. 3

Heymann
18 cm / 7"

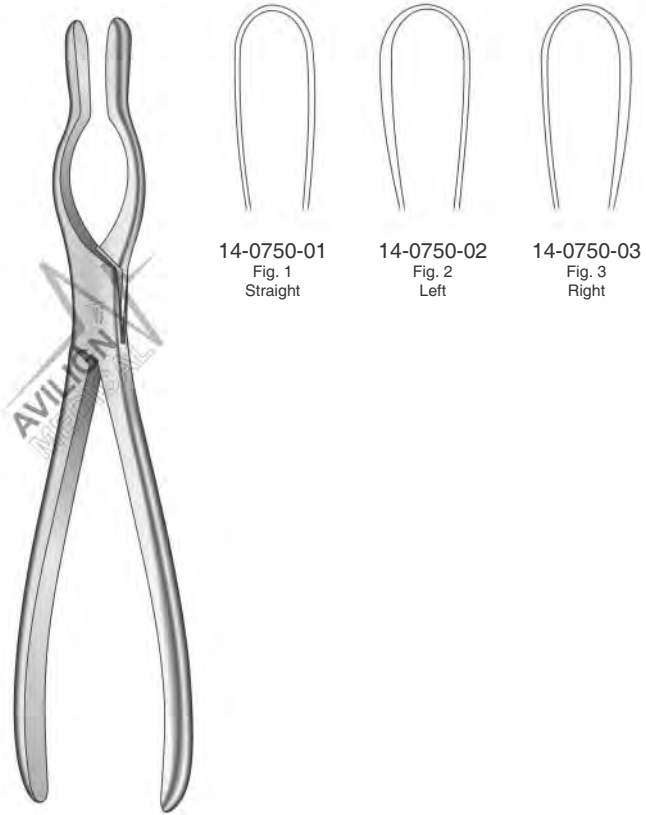

14-0750-01 Fig. 1
Straight
14-0750-02 Fig. 2
Left
14-0750-03 Fig. 3
Right

Cottle-Walsham
23 cm / 9"

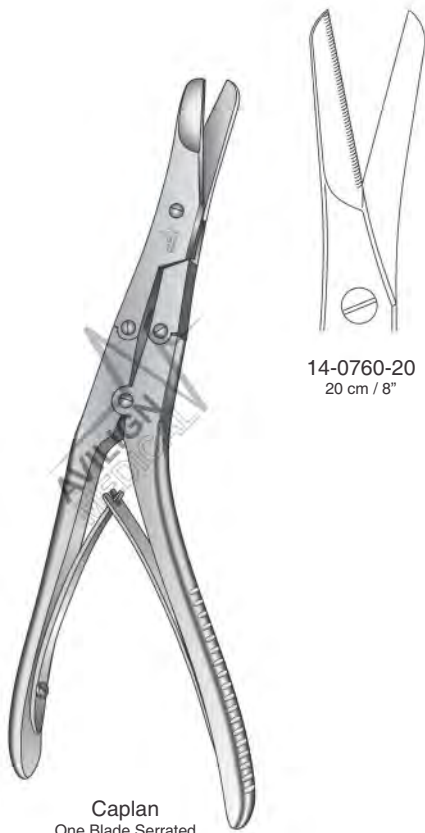

14-0760-20
20 cm / 8"

Caplan
One Blade Serrated

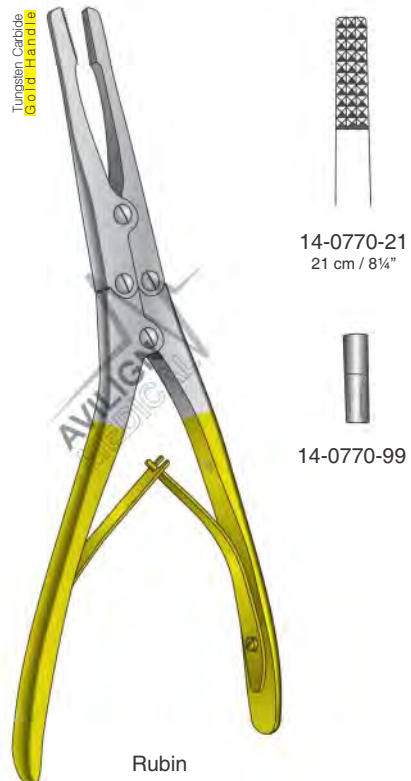

14-0770-21
21 cm / 8¼"

14-0770-99

Rubin



15

Micro Instruments

Mikro-Instrumente
Instrumentos de micro
Strumentario micro



Hartmann (French)
 15-0010-01 C₂ 16 Hz
 15-0010-02 C₁ 32 Hz
 15-0010-03 C 64 Hz
 15-0010-04 C 128 Hz
 15-0010-05 C₁ 256 Hz
 With Clamp



Hartmann
 15-0020-01 c 128 Hz
 15-0020-02 c₁ 256 Hz
 15-0020-03 c₂ 512 Hz
 15-0020-04 c₃ 1024 Hz
 15-0020-05 c₄ 2048 Hz
 15-0020-06 c₅ 4096 Hz



Lucae
 15-0030-01 c 128 Hz
 15-0030-02 c₁ 256 Hz
 15-0030-03 c₂ 512 Hz
 15-0030-04 c₃ 1024 Hz
 15-0030-05 c₄ 2048 Hz
 15-0030-06 c₅ 4096 Hz
 With Foot

Hartmann
 15-0040-00
 Complete Set,
 Consisting Of: 15-0020-03, 15-0020-04, 15-0020-05
 15-0010-04, 15-0010-05

Hartmann
 15-0050-00
 Complete Set,
 Consisting Of: 15-0020-03, 15-0020-04, 15-0020-05, 15-0020-06
 15-0010-04, 15-0010-05

Hartmann
 15-0060-00
 Complete Set,
 Consisting Of: 15-0020-03, 15-0020-04, 15-0020-05, 15-0020-06
 15-0010-02, 15-0010-03, 15-0010-04, 15-0010-05



Stimmgabeln
 Diapasónes
 Diapason
 Tuning Forks



Aluminum
Instrument

15-0070-01 c 64 Hz
 15-0070-02 c 128 Hz
 15-0070-03 c 256 Hz
 With Clamp



Aluminum
Instrument

15-0080-04 c_s 512 Hz
 15-0080-05 c_s 1024 Hz
 15-0080-06 c_r 2048 Hz
 15-0080-07 c_s 4096 Hz



Hartmann
 15-0090-01
 c 128 Hz
 Adjustable Up To H 240 Hz



Rydel-Seiffer
 15-0100-01
 With Clamp c 64 HZ
 Without Clamp c 128 HZ

Aluminum
Instrument

15-0110-00
 Complete Set
 Consisting of : 15-0070-02 to 15-0070-03
 15-0080-04 to 15-0080-06





15-0120-05 50 ml
15-0120-07 75 ml
15-0120-10 100 ml
15-0120-15 150 ml
Complete



15-0130-01



15-0130-02



15-0130-03



Inside Diameter



15-0140-02 2 mm Fig. 1
15-0140-03 3 mm Fig. 2
15-0140-04 4 mm Fig. 3
15-0140-05 5 mm Fig. 4



Inside Diameter



15-0150-01 1.7 mm Fig. 1
15-0150-02 3.2 mm Fig. 2
15-0150-03 4.7 mm Fig. 3



Politzer
27 mm
Chrome Plated

15-0140-30
Complete Set,
Consisting of : 15-0140-02, 15-0140-03, 15-0140-04













15-0140-40
Complete Set,
Consisting of: 15-0140-02, 15-0140-03, 15-0140-04, 15-0140-05



Hartmann
15-0150-30
Complete Set,
Consisting Of : 15-0150-01, 15-0150-02, 15-0150-03



Inside Diameter

- | | | | | | | | |
|---|---|---|---|---|---|---|---|
|  |  |  |  |  |  |  |  |
| 15-0160-01
3 mm
Fig. 1 | 15-0160-02
3.5 mm
Fig. 2 | 15-0160-03
4 mm
Fig. 3 | 15-0160-04
4.5 mm
Fig. 4 | 15-0160-05
5 mm
Fig. 5 | 15-0160-06
5.5 mm
Fig. 6 | 15-0160-07
6 mm
Fig. 7 | 15-0160-08
6.5 mm
Fig. 8 |
| | | | |  |  |  |  |
| | | | | 15-0160-09
7 mm
Fig. 9 | 15-0160-10
7.5 mm
Fig. 10 | 15-0160-11
8 mm
Fig. 11 | 15-0160-12
9 mm
Fig. 12 |



Hartmann
Stainless Steel

15-0160-20
Complete Set,
Consisting of: 15-0160-11, 15-0160-12

15-0160-30
Complete Set,
Consisting of: 15-0160-01, 15-0160-03, 15-0160-06

15-0160-40
Complete Set,
Consisting of: 15-0160-01, 15-0160-03, 15-0160-06, 15-0160-09



Inside Diameter

- | | | | |
|---|---|---|---|
|  |  |  |  |
| 15-0170-01
2.8 x 3.8 mm
Fig. 1 | 15-0170-02
3.8 x 4.8 mm
Fig. 2 | 15-0170-03
5 x 6.2 mm
Fig. 3 | 15-0170-04
6 x 7.2 mm
Fig. 4 |



Gruber
42 mm
Chrome Plated

15-0170-40
Complete Set,
Consisting of: 15-0170-01, 15-0170-02, 15-0170-03, 15-0170-04

15-0170-30
Complete Set,
Consisting of: 15-0170-02, 15-0170-03, 15-0170-04



Inside Diameter

- | | | |
|---|---|---|
|  |  |  |
| 15-0180-01
1.7 mm
Fig. 1 | 15-0180-02
3.2 mm
Fig. 2 | 15-0180-03
4.7 mm
Fig. 3 |



Hartmann
Stainless Steel

15-0180-30
Complete Set,
Consisting of: 15-0180-01, 15-0180-02, 15-0180-03



Buck
17 cm / 6¾"
Ear Curettes

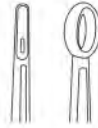

- 15-0190-01 1.5 mm, Fig. 000
- 15-0190-02 2.0 mm, Fig. 00
- 15-0190-03 2.5 mm, Fig. 0
- 15-0190-04 3.0 mm, Fig. 1
- 15-0190-05 3.5 mm, Fig. 2
- 15-0190-06 4.0 mm, Fig. 3
- 15-0190-07 4.5 mm, Fig. 4
- 15-0190-08 5.0 mm, Fig. 5
- Straight, Blunt

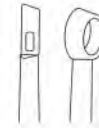

- 15-0210-01 1.5 mm, Fig. 000
- 15-0210-02 2.0 mm, Fig. 00
- 15-0210-03 2.5 mm, Fig. 0
- 15-0210-04 3.0 mm, Fig. 1
- 15-0210-05 3.5 mm, Fig. 2
- 15-0210-06 4.0 mm, Fig. 3
- 15-0210-07 4.5 mm, Fig. 4
- 15-0210-08 5.0 mm, Fig. 5
- Straight, Sharp



- 15-0200-01 1.5 mm, Fig. 000
- 15-0200-02 2.0 mm, Fig. 00
- 15-0200-03 2.5 mm, Fig. 0
- 15-0200-04 3.0 mm, Fig. 1
- 15-0200-05 3.5 mm, Fig. 2
- 15-0200-06 4.0 mm, Fig. 3
- 15-0200-07 4.5 mm, Fig. 4
- 15-0200-08 5.0 mm, Fig. 5
- Angled, Blunt



- 15-0220-01 1.5 mm, Fig. 000
- 15-0220-02 2.0 mm, Fig. 00
- 15-0220-03 2.5 mm, Fig. 0
- 15-0220-04 3.0 mm, Fig. 1
- 15-0220-05 3.5 mm, Fig. 2
- 15-0220-06 4.0 mm, Fig. 3
- 15-0220-07 4.5 mm, Fig. 4
- 15-0220-08 5.0 mm, Fig. 5
- Angled, Sharp

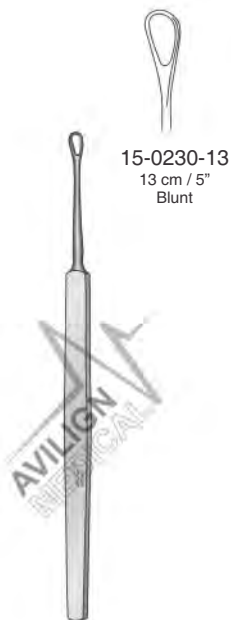

Langenbeck
Ear Loop

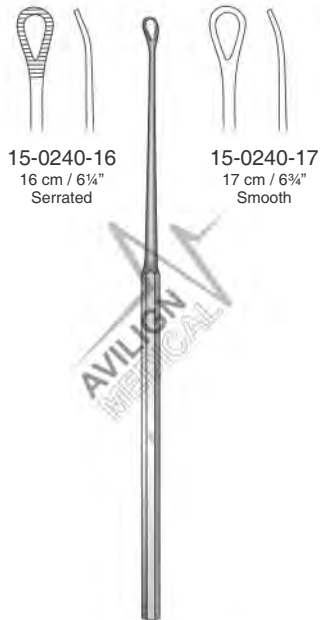

Snellen
Ear Loop

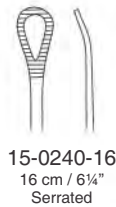

Billeau
Ear loop



Ohrküretten, Ohrschlingen, Ohrhakken
 Curetas Auriculares, Asas Auriculares, Ganchitos Auriculares
 Curette Auricolari, Anse Auricolari, Uncini Auricolari
 Ear Currettes, Ear Loops, Ear Hooks



15-0260-01
 Fig. 1
 Straight

15-0260-03
 Fig. 1
 Angled

Shapleigh
 13 cm / 5"
 Ear Loops



15-0260-02
 Fig. 2
 Straight

15-0260-04
 Fig. 2
 Angled



Jansen
 15-0270-15
 15 cm / 6"
 Ear Curette



15-0280-16
 15 cm / 6"



Zaufal
 Ear Lever



15-0290-15
 15 cm / 6"



Zaufal-Jansen
 Ear Hook



15-0300-16
 16 cm / 6¼"



Hartmann
 Ear Hook
 Sharp

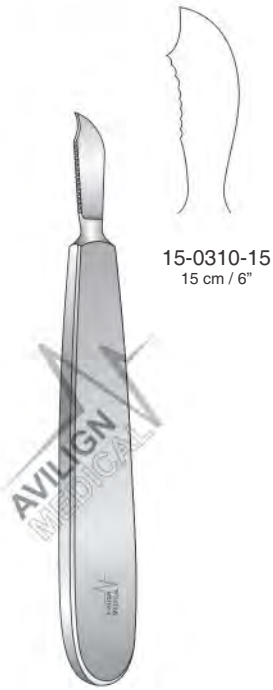

15-0310-15
15 cm / 6"

Muck
Periosteal knife



15-0320-15
15 cm / 6"

Buck
Myringotome



15-0330-16
16 cm / 6¼"

Politzer
Furuncle Knife

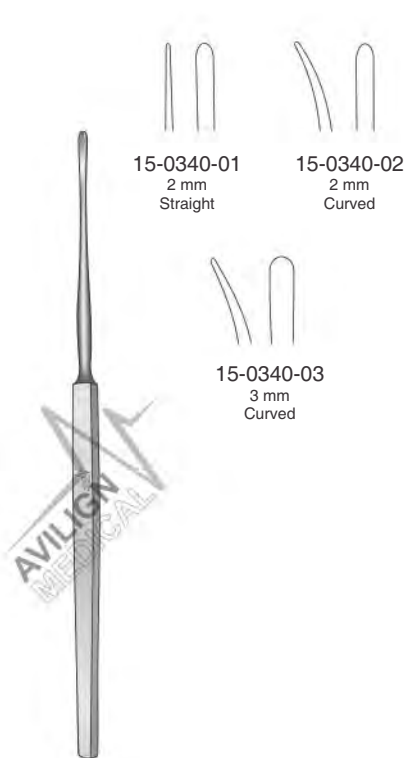

15-0340-01
2 mm
Straight

15-0340-02
2 mm
Curved

15-0340-03
3 mm
Curved

Lempert
16.5 cm / 6½"
Elevator



15-0350-18
6 mm

Lempert
18 cm / 7"
Elevator



Krause
15-0360-16
18 cm / 7"

Ohrpolypenzangen, Ohrzängchen
 Pinzas Para Pólipos Auriculares, Pinzas Auriculares
 Pinze Per Polipi Auricolari, Pinze Auricolari
 Ear Polypus Forceps, Ear Forceps



Littauer
 15-0370-12
 12 cm / 4¾"



Hartmann
 15-0380-12
 12 cm / 4¾"



Hartmann
 15-0390-14
 14 cm / 5½"



Hartmann
 15-0400-14
 8.5 cm / 3"
 Grasping Forceps, Duckbill Jaw

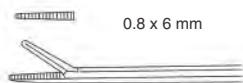

Hartmann-Wullstein
 15-0410-08
 8.5 cm / 3"
 Grasping Forceps

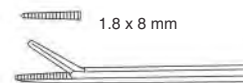

Hartmann-Wullstein
 15-0420-08
 8.5 cm / 3"
 Grasping Forceps



Hartmann
 15-0430-08 8.5 cm / 3"
 15-0430-14 14 cm / 5½"
 15-0430-16 16.5 cm / 6½"
 Grasping Forceps



Hartmann
 15-0440-15
 15 cm / 6"
 Grasping Forceps, Delicate, Serrated



Hartmann
 15-0450-15
 15 cm / 6"
 Grasping Forceps, Rough, Serrated

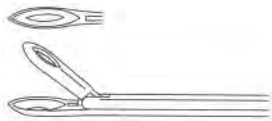
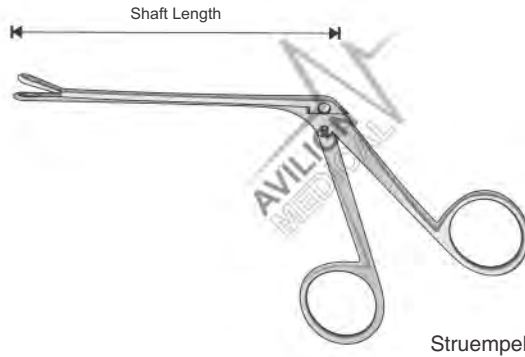

15-0460-08 8.5 cm / 3"
15-0460-12 12.5 cm / 5"
Spoon Forceps, Oval



15-0470-12
12.5 cm / 5"
Spoon Forceps, Oval, 45°



15-0480-12
12.5 cm / 5"
Spoon Forceps, Oval, 90°

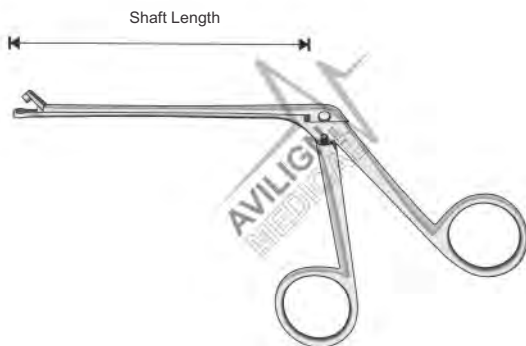

15-0490-12
12.5 cm / 5"
Grasping Forceps, 45°

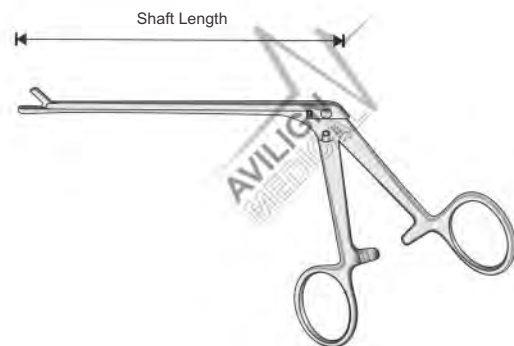

Masing
15-0500-09
8.5 cm / 3"
Needle Holder



15-0510-09
8.5 cm / 3"
Needle Holder

Ohrzängchen
 Pinzas auriculares
 Pinze auricolari
 Ear Forceps

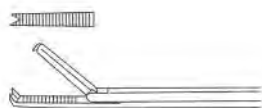
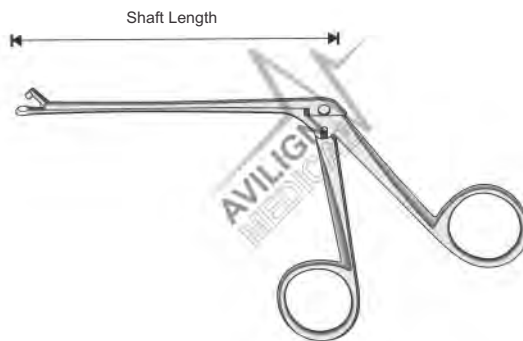

Hartmann
 15-0520-08 8.5 cm / 3"
 15-0520-14 14 cm / 5½"
 Grasping forceps, 1 x 2 teeth

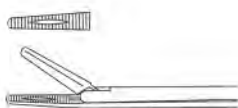

Hartmann-Noyes
 15-0530-09
 8.5 cm / 3"
 Grasping Forceps

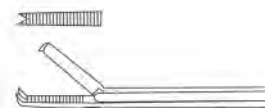

Hartmann-Noyes
 15-0540-09
 8.5 cm / 3"
 Grasping Forceps, 1 X 2 Teeth

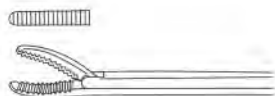

Hartmann-Weingaertner
 15-0550-09
 8.5 cm / 3"
 Grasping Forceps

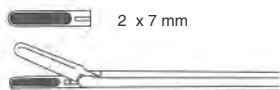

Hartmann
 15-0560-09
 8.5 cm / 3"
 Spoon Forceps, Oval

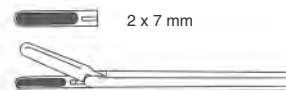

Hartmann
 15-0570-18
 18.0 cm / 7"
 Spoon Forceps, Oval

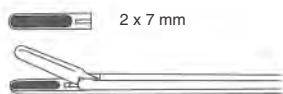

Hartmann
 15-0580-18
 18 cm / 7"
 Spoon Forceps, Oval



Hartmann
 15-0590-01 Ø 2.0 mm
 15-0590-02 Ø 2.5 mm
 15-0590-03 Ø 3.0 mm
 Spoon Forceps
 8.5 cm / 3⅓"



Hartmann
 15-0600-11
 Ø 2.0 mm
 Spoon Forceps
 15.0 cm / 6"

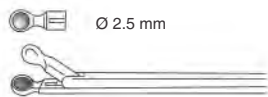

Hartmann
 15-0610-12
 Spoon Forceps
 12.5 cm / 5"

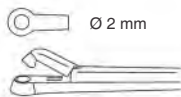

Hartmann-Hoffmann
 15-0620-02
 Spoon Forceps, Through Cut
 8.5 cm / 3⅓"



Hartmann
 15-0630-02 Ø 2.0 mm
 15-0630-03 Ø 3.0 mm
 Spoon Forceps, 45°
 8.5 cm / 3⅓"



15-0640-01 4 x 0.8 mm
15-0640-02 4 x 0.6 mm
15-0640-03 3 x 0.6 mm
Smooth, Straight
Shaft Length 8 cm / 3"

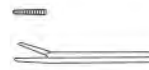

15-0650-01 4 x 0.8 mm
15-0650-02 4 x 0.6 mm
15-0650-03 3 x 0.6 mm
Serrated, Straight
Shaft Length 8 cm / 3"



15-0660-01 4 x 0.8 mm
15-0660-02 4 x 0.6 mm
Serrated, Straight
Shaft Length 12.5 cm / 5"



15-0670-01 4 x 0.8 mm
15-0670-02 4 x 0.6 mm
Serrated, Curved Upwards
Shaft Length 8 cm / 3"



15-0680-01 4 x 0.8 mm
15-0680-02 4 x 0.6 mm
Serrated, Right
Shaft Length 8 cm / 3"

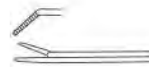

15-0690-01 4 x 0.8 mm
15-0690-02 4 x 0.6 mm
Serrated, left
Shaft Length 8 cm / 3"



15-0700-01 4 x 0.8 mm
15-0700-02 4 x 0.6 mm
Serrated, Curved Downwards
Shaft Length 8 cm / 3"

Mikro-löffelzängchen
 Micro Pinzas De Copas
 Micropinze Con Morsi A Cucchiaio
 Micro Cup-shaped Forceps

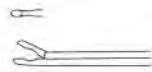
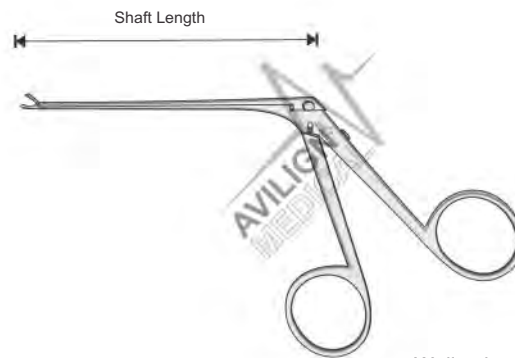

15-0710-01
 Ø 1.0 mm
 Straight, Round
 Shaft Length 12.5 cm / 5"

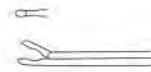

15-0720-01 1.5 x 0.8 mm
15-0720-02 1.0 x 0.9 mm
15-0720-03 0.6 x 0.5 mm
 Straight, Oval
 Shaft Length 8 cm / 3"



15-0730-01 1.5 x 0.8 mm
15-0730-02 1.0 x 0.9 mm
15-0730-03 0.6 x 0.5 mm
 Curved Upwards, Oval
 Shaft Length 8 cm / 3"



15-0740-01 1.5 x 0.8 mm
15-0740-02 1.0 x 0.9 mm
15-0740-03 0.6 x 0.5 mm
 Right, Oval
 Shaft Length 8 cm / 3"

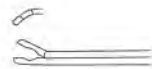

15-0750-01 1.5 x 0.8 mm
15-0750-02 1.0 x 0.9 mm
15-0750-03 0.6 x 0.5 mm
 Left, Oval
 Shaft Length 8 cm / 3"

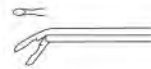

15-0760-01 1.5 x 0.8 mm
15-0760-02 1.0 x 0.9 mm
15-0760-03 0.6 x 0.5 mm
 Curved Downwards, Oval
 Shaft Length 8 cm / 3"

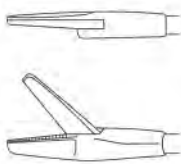
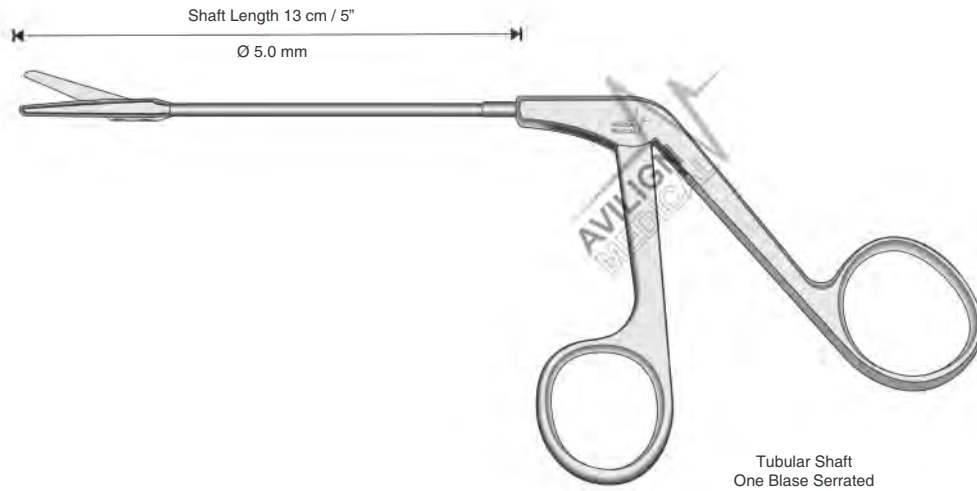

15-0770-00
Straight

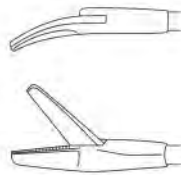

15-0770-01
Curved Left

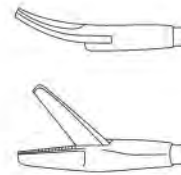

15-0770-02
Curved Right

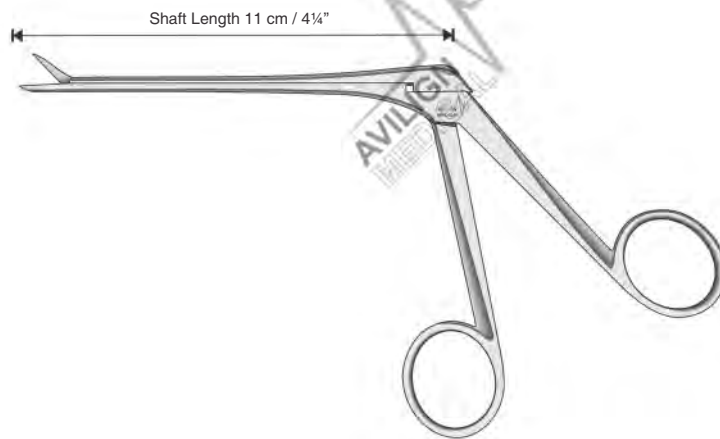

15-0780-00
Straight
One Blade Serrated



15-0780-01
Curved Left
One Blade Serrated

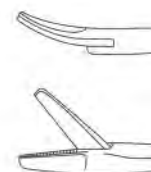

15-0780-02
Curved Right
One Blade Serrated



16

Thorax, Lungs

Thorax, Lunge
Thoracio, Pulmon
Thorace, Oulmone

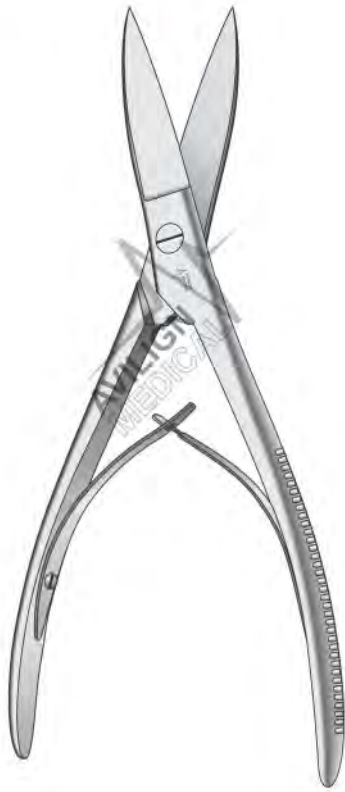

16-0010-23
23 cm / 9"

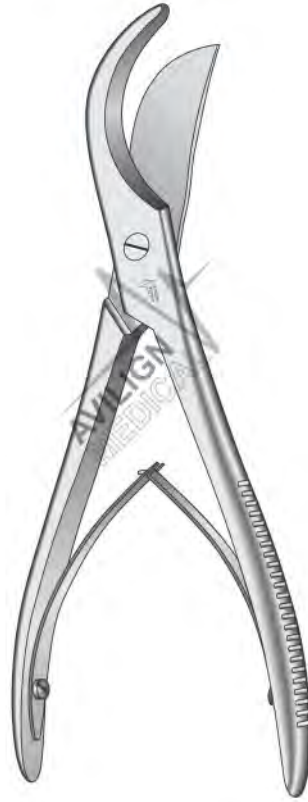

16-0020-22
23 cm / 9"



Lebsche
16-0030-24
24 cm / 9½"

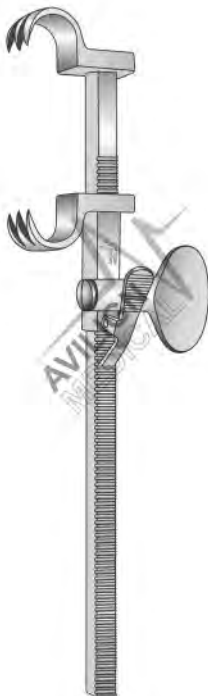

Bailey-Gibbon
16-0040-16
18 cm / 7"
For Children



Allison



16-0050-26 26 cm / 10¼"
40 mm
16-0050-32 32 cm / 12½"
65 mm

Rippensperrer Aus Aluminium
 Separadores Costales De Aluminio
 Divaricatori Costali In Alluminio
 Rib Spreader Aluminium

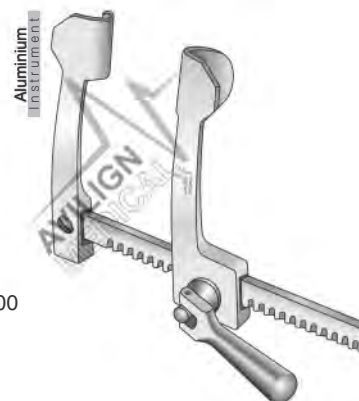
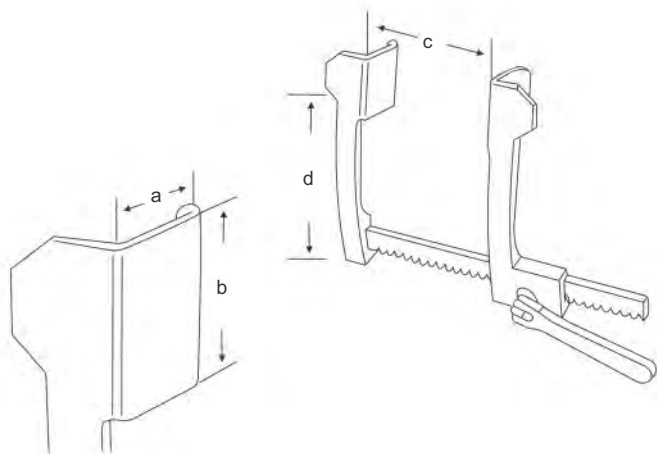

Cooley
 16-0060-00
 a = 14 mm
 b = 16 mm
 c = 85 mm
 d = 55 mm
 For Infants

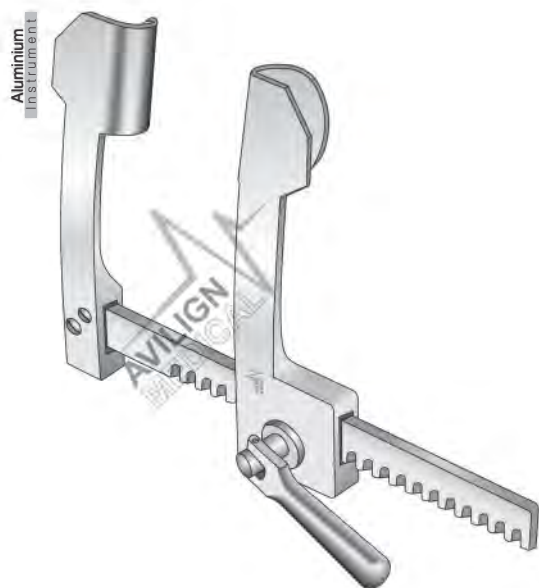

Cooley
 16-0070-00
 a = 15 mm
 b = 30 mm
 c = 115 mm
 d = 80 mm
 For Children

16-0070-01
 a = 15 mm
 b = 30 mm
 c = 140 mm
 d = 80 mm

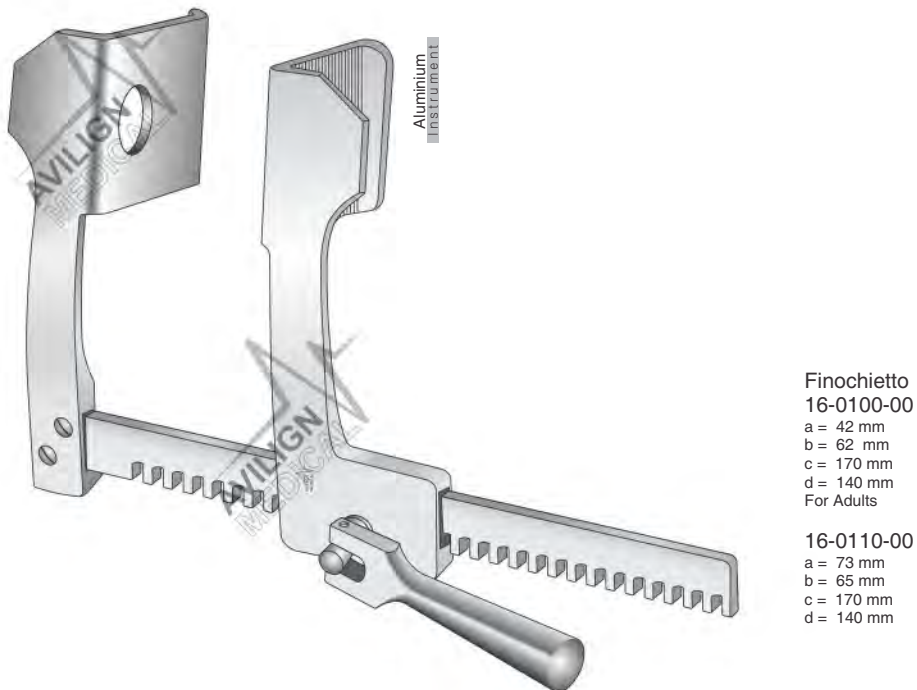
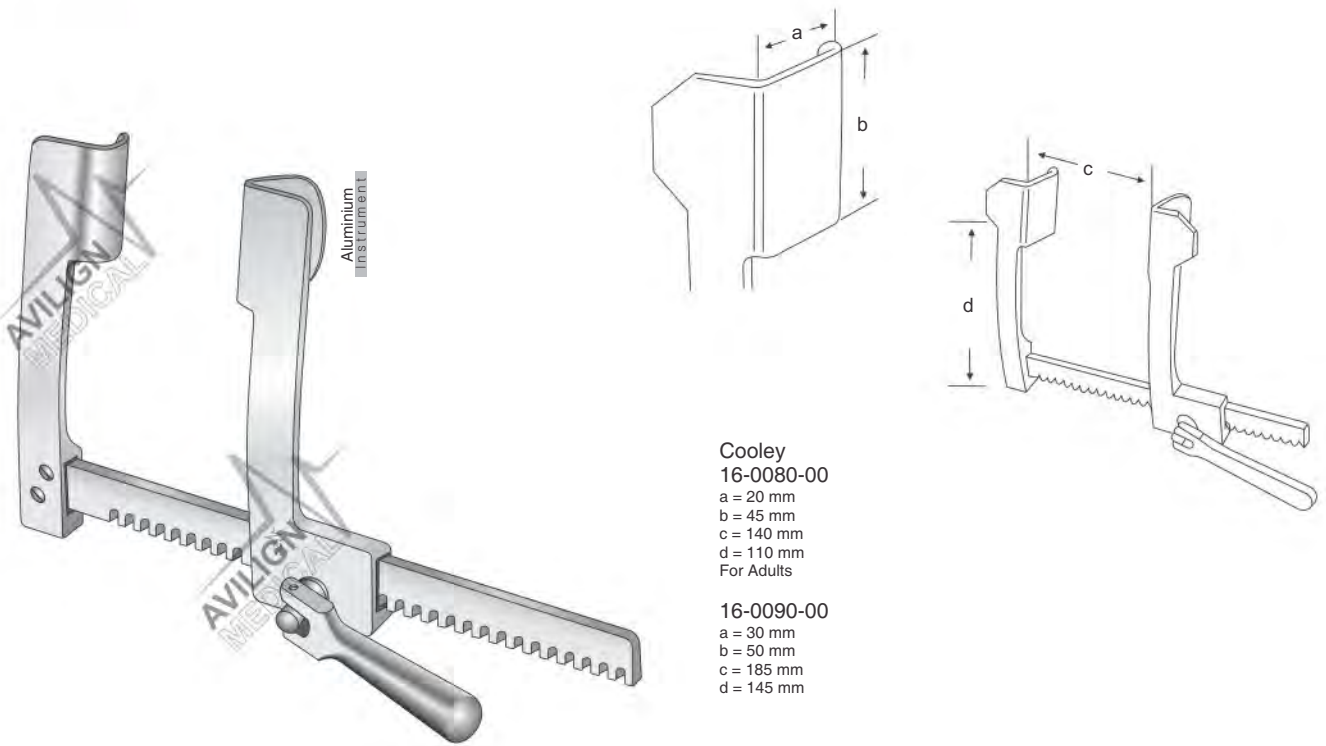

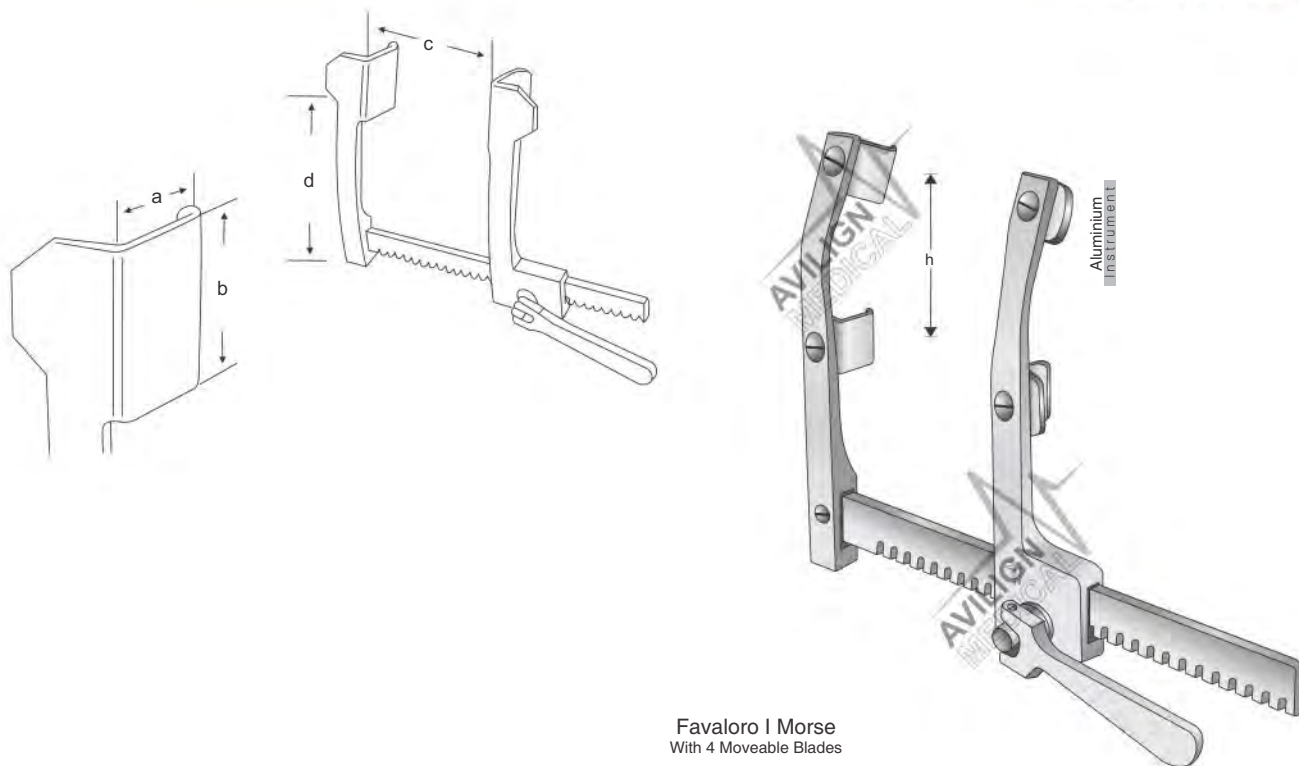

Favalo I Morse
 With 4 Moveable Blades

16-0120-00
 h = 50 mm
 a = 17 mm
 b = 22 mm
 c = 160 mm
 d = 120 mm
 For Children

16-0130-00
 h = 50 mm
 a = 20 mm
 b = 20 mm
 c = 155 mm
 d = 120 mm
 For Children

16-0140-00
 h = 65 mm
 a = 40 mm
 b = 20 mm
 c = 155 mm
 d = 175 mm
 For Adults

16-0150-00
 h = 72 mm
 a = 40 mm
 b = 28 mm
 c = 210 mm
 d = 155 mm
 For Adults

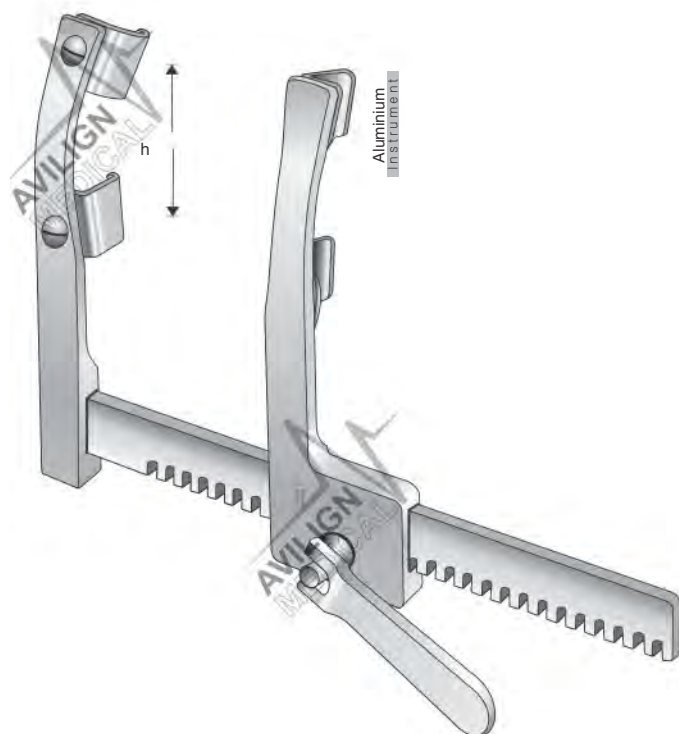

Morse
 With 4 Moveable Blades
16-0160-00
 h = 72 mm
 a = 20 mm
 b = 28 mm
 c = 200 mm
 d = 150 mm
 For Adults

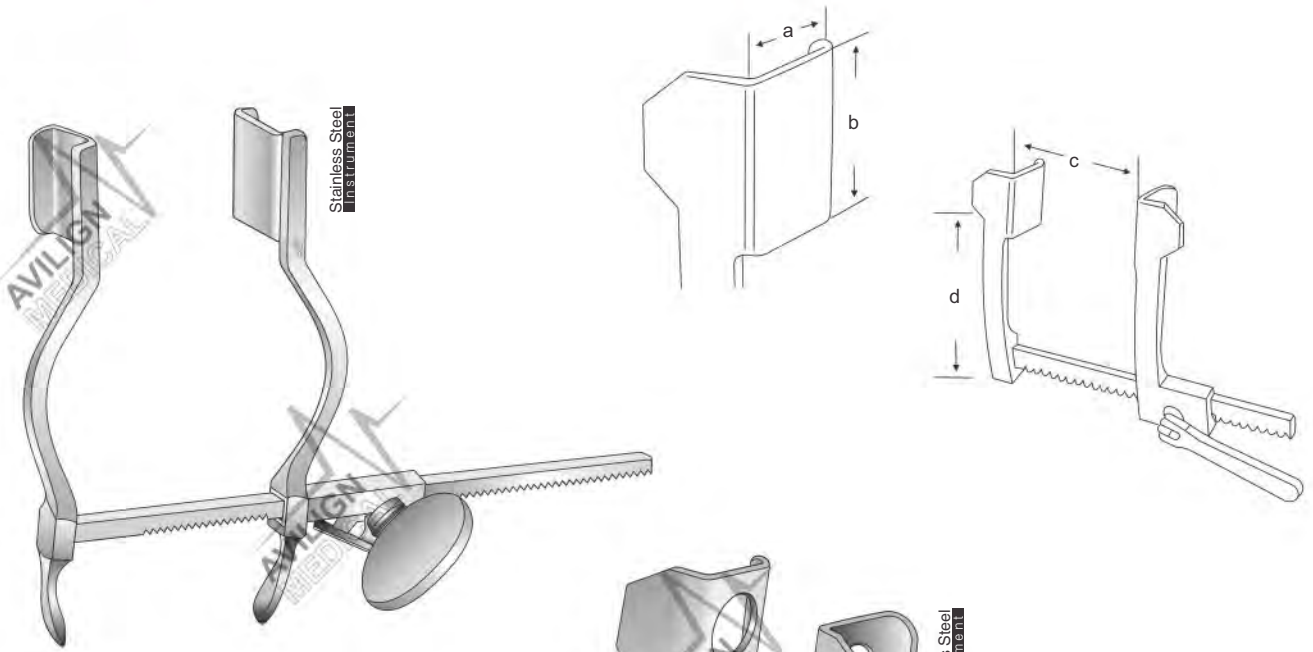

Hertzler
16-0170-00
a = 20 mm
b = 25 mm
c = 105 mm
d = 120 mm

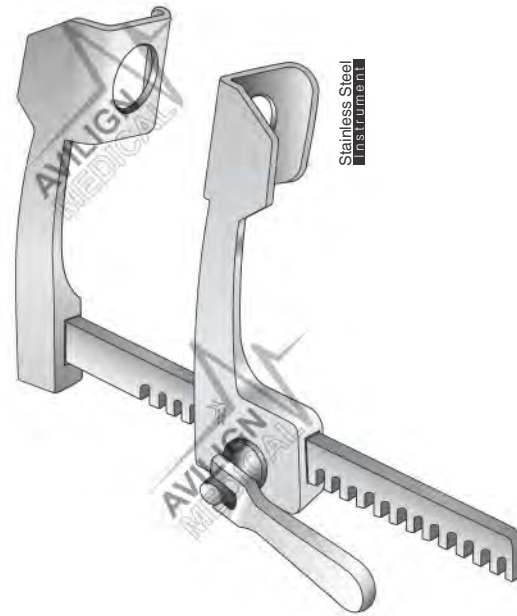

Finochietto
16-0180-00 16-0190-00
a = 28 mm a = 30 mm
b = 30 mm b = 45 mm
c = 100 mm c = 140 mm
d = 75 mm d = 110 mm
For Children For Children

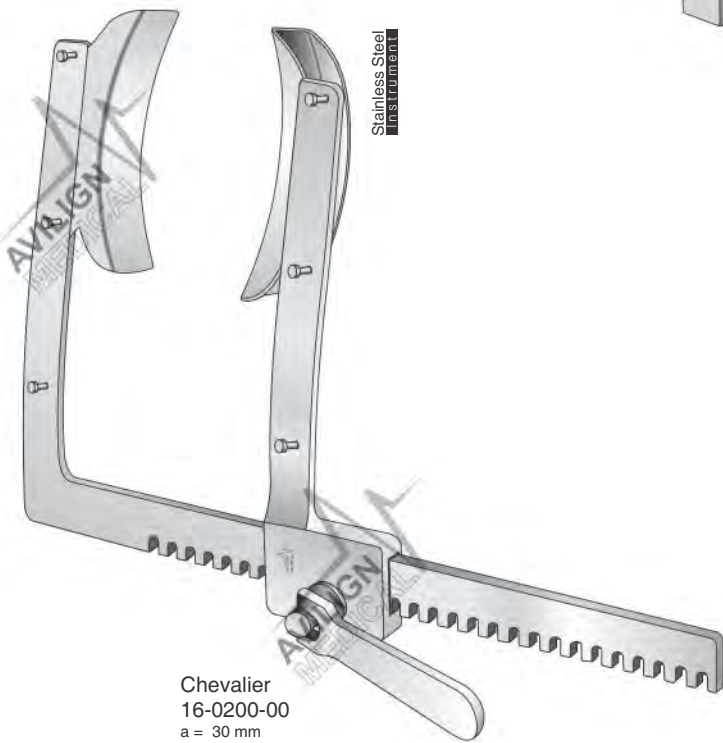

Chevalier
16-0200-00
a = 30 mm
b = 100 mm
c = 210 mm
d = 185 mm
For Adults

Rippensperrer
 Separadores Costales
 Divaricatori Costali
 Rib Spreader

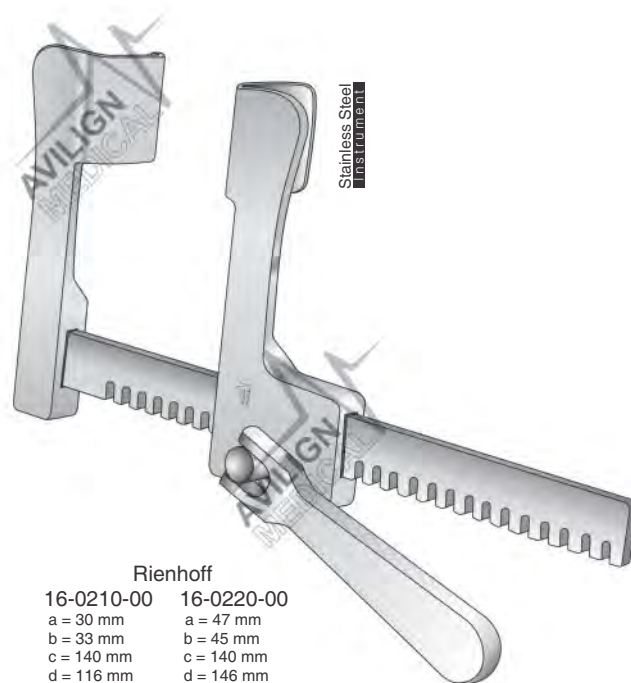
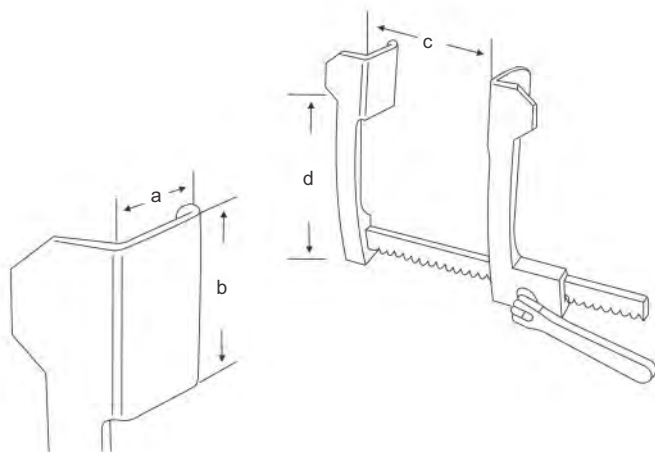

Stainless Steel
Instrument

Rienhoff

16-0210-00	16-0220-00
a = 30 mm	a = 47 mm
b = 33 mm	b = 45 mm
c = 140 mm	c = 140 mm
d = 116 mm	d = 146 mm
For Children	For Children

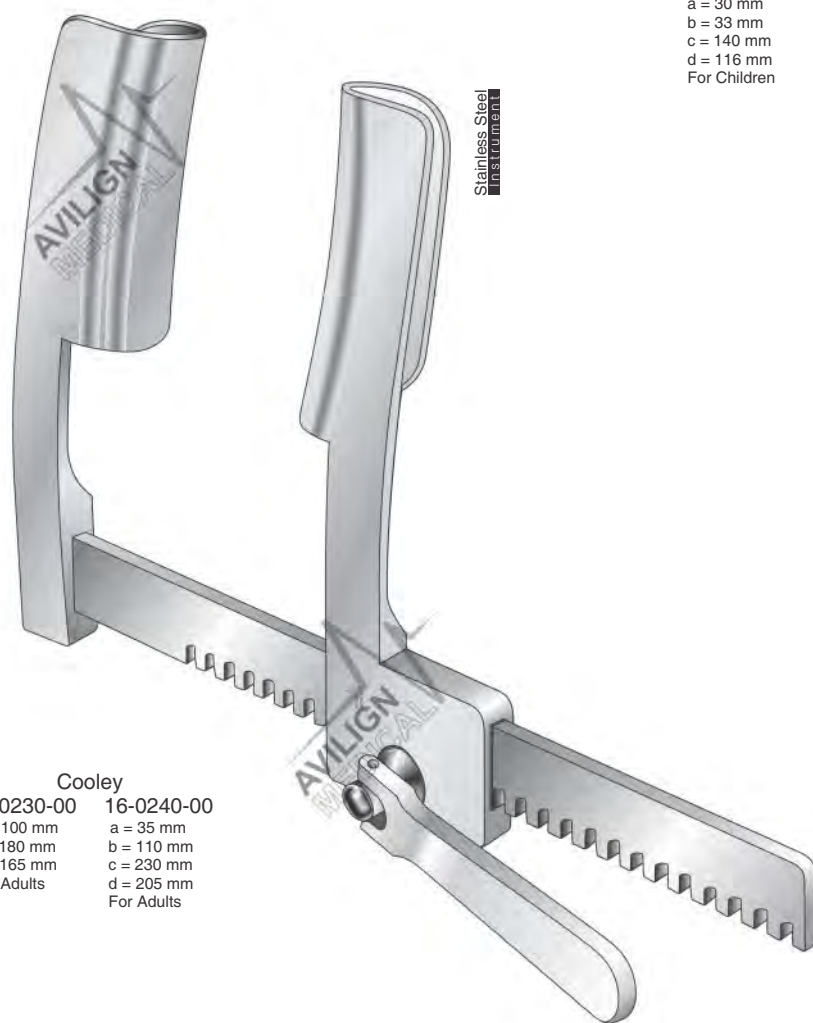

Stainless Steel
Instrument

Cooley

16-0230-00	16-0240-00
b = 100 mm	a = 35 mm
c = 180 mm	b = 110 mm
d = 165 mm	c = 230 mm
For Adults	d = 205 mm
	For Adults

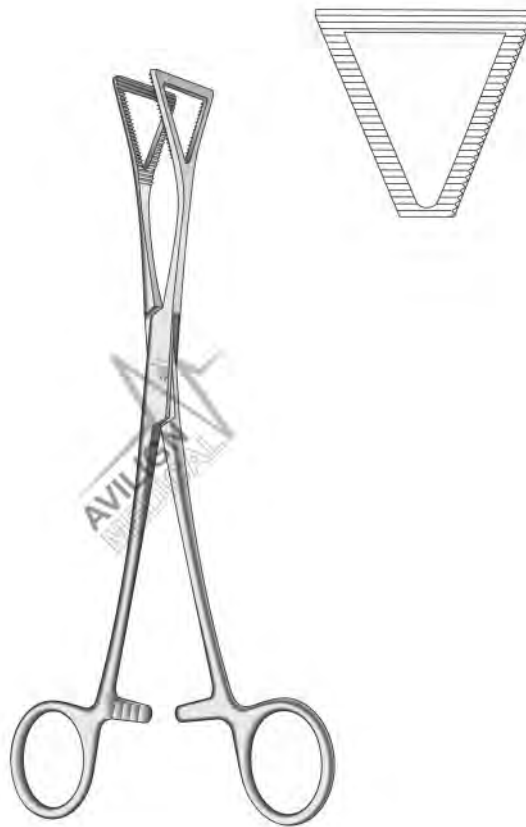

Lovelace
16-0250-00
20 cm / 8"



17

Cardiovascular

Herz-und Gefasschirurgie

Cirurgia cardiovascular

Chirurgia cardiovascolare



Aluminium Instrument

Ø 0.5 mm	Ø 1 mm	Ø 1.5 mm	Ø 2 mm	Ø 2.5 mm	Ø 3 mm	Ø 4 mm	Ø 5 mm
17-0010-13 13 cm / 5"	17-0020-13 13 cm / 5"	17-0030-13 13 cm / 5"	17-0040-13 13 cm / 5"	17-0050-13 13 cm / 5"	17-0060-13 13 cm / 5"	17-0070-13 13 cm / 5"	17-0080-13 13 cm / 5"
17-0010-15 15 cm / 6"	17-0020-15 15 cm / 6"	17-0030-15 15 cm / 6"	17-0040-15 15 cm / 6"	17-0050-15 15 cm / 6"	17-0060-15 15 cm / 6"	17-0070-15 15 cm / 6"	17-0080-15 15 cm / 6"
17-0010-20 20 cm / 8"	17-0020-20 20 cm / 8"	17-0030-20 20 cm / 8"	17-0040-20 20 cm / 8"	17-0050-20 20 cm / 8"	17-0060-20 20 cm / 8"	17-0070-20 20 cm / 8"	17-0080-20 20 cm / 8"

Cooley
Aluminium Handle
Malleable













Ø 0.5 mm	Ø 1 mm	Ø 1.5 mm	Ø 2 mm	Ø 2.5 mm	Ø 3 mm
17-0090-19 19 cm / 7½"	17-0100-19 19 cm / 7½"	17-0110-19 19 cm / 7½"	17-0120-19 19 cm / 7½"	17-0130-19 19 cm / 7½"	17-0140-19 19 cm / 7½"
17-0090-35 35 cm / 13¾"	17-0100-35 35 cm / 13¾"	17-0110-35 35 cm / 13¾"	17-0120-35 35 cm / 13¾"	17-0130-35 35 cm / 13¾"	17-0140-35 35 cm / 13¾"

Ø 3.5 mm	Ø 4 mm	Ø 4.5 mm	Ø 5 mm	Ø 7 mm	Ø 9 mm
17-0150-19 19 cm / 7½"	17-0160-19 19 cm / 7½"	17-0170-19 19 cm / 7½"	17-0180-19 19 cm / 7½"	17-0190-19 19 cm / 7½"	17-0200-19 19 cm / 7½"
17-0150-35 35 cm / 13¾"	17-0160-35 35 cm / 13¾"	17-0170-35 35 cm / 13¾"	17-0180-35 35 cm / 13¾"	17-0190-35 35 cm / 13¾"	17-0200-35 35 cm / 13¾"

De Bakey
Malleable

Gefäßdilatoren, Dura Dissektoren
 Dilatadores Vasculares, Disectores Para Duramadre
 Dilatori Vascolari, Dissettori Per La Dura-madre
 Vascular Dilators, Dura Dissectors



				
Ø 0.5 mm	Ø 1 mm	Ø 1.5 mm	Ø 2 mm	Ø 2.5 mm
17-0210-14 14 cm / 5½"	17-0220-14 14 cm / 5½"	17-0230-14 14 cm / 5½"	17-0240-14 14 cm / 5½"	17-0250-14 14 cm / 5½"
17-0210-21 21 cm / 8¼"	17-0220-21 21 cm / 8¼"	17-0230-21 21 cm / 8¼"	17-0240-21 21 cm / 8¼"	17-0250-21 21 cm / 8¼"
				
Ø 3 mm	Ø 3.5 mm	Ø 4 mm	Ø 4.5 mm	Ø 5 mm
17-0260-14 14 cm / 5½"	17-0270-14 14 cm / 5½"	17-0280-14 14 cm / 5½"	17-0290-14 14 cm / 5½"	17-0300-14 14 cm / 5½"
17-0260-21 21 cm / 8¼"	17-0270-21 21 cm / 8¼"	17-0280-21 21 cm / 8¼"	17-0290-21 21 cm / 8¼"	17-0300-21 21 cm / 8¼"

Garrett Set
 17-0310-00
 14 cm / 5½"
 Complete Set
 10 Pieces

17-0320-00
 21 cm / 8¼"
 Complete Set
 10 Pieces

Garrett
 Malleable



Penfield
 17-0330-17
 17.5 cm / 7"



Penfield
 17-0340-19
 19.5 cm / 7¾"



Pennybacker
 17-0350-23
 23 cm / 9"

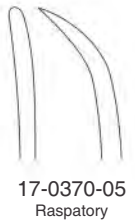
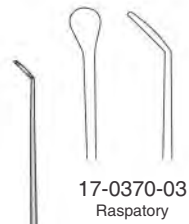

Yasargil
18.5 cm / 7¼"



Yasargil
18.5 cm / 7¼"



Yasargil
18.5 cm / 7¼"



Yasargil
18.5 cm / 7¼"



Yasargil
18.5 cm / 7¼"

18

Stomach
Intestines, Rectum

Magen, Darm, Rektum
Estómago, Intestino, Recto
Stomaco, Intestino, Retto

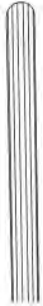

18-0010-13
Straight



18-0020-13
Curved

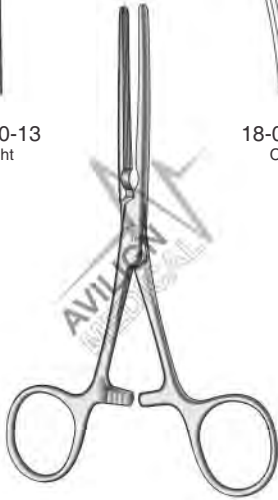

Baby-Kocher
13 cm / 5"
1 x 2 Teeth

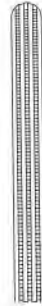

18-0030-13
Straight

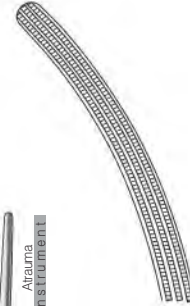

18-0040-13
Curved

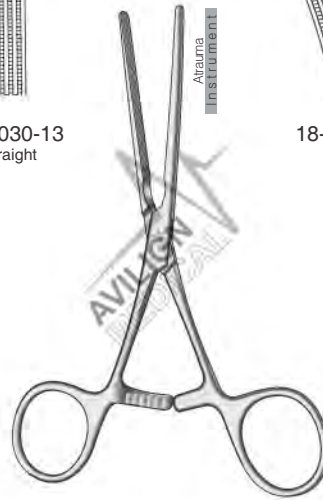

Baby-Kocher
13 cm / 5"



18-0050-16
16.5 cm / 6½"

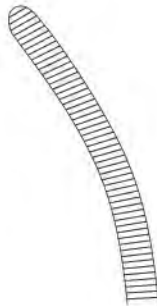

18-0060-16
16.5 cm / 6½"

18-0050-18
18 cm / 7"
Straight

18-0060-18
18 cm / 7"
Curved

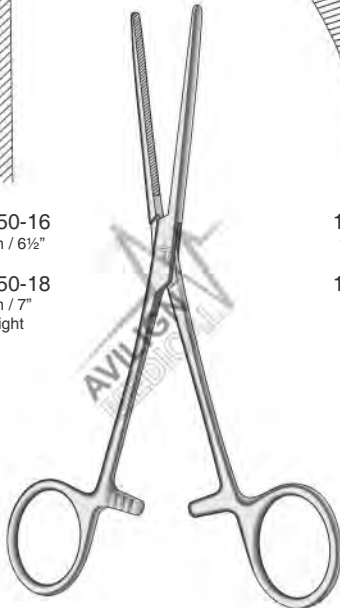

Doyen



18-0070-13
18-0070-17
18-0070-18
18-0070-21
18-0070-23
Straight

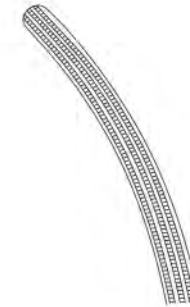

14 cm / 5½"
17 cm / 6¾"
18.5 cm / 7¼"
21.5 cm / 8½"
23.5 cm / 9¼"
Curved

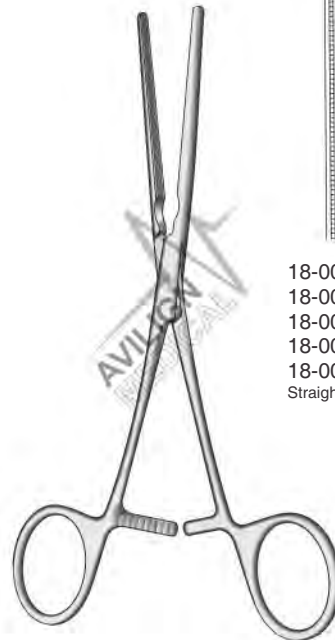

Doyen

Darmklemmen
 Pinzas Clamps Intestinales
 Pinze Intestinali
 Intestinal Forceps

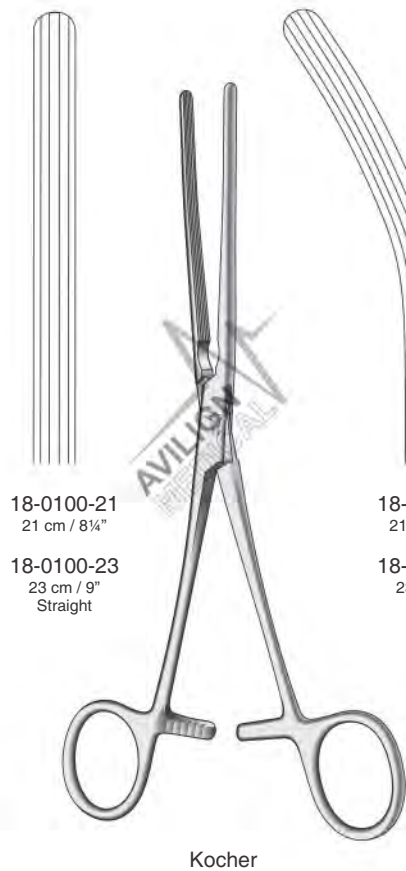
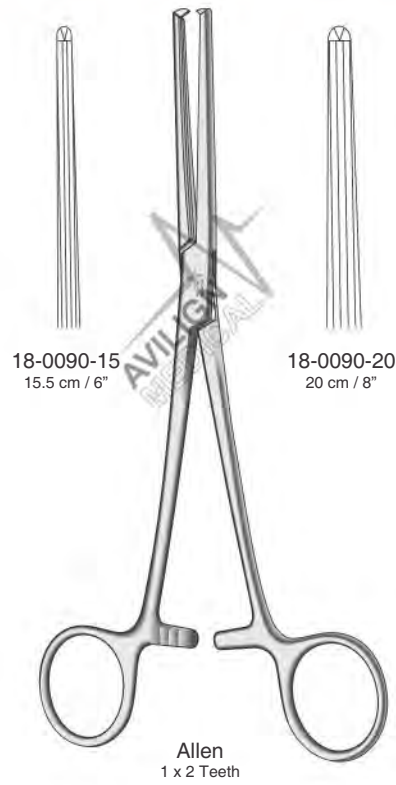

18-0110-21
 21 cm / 8 1/4"

18-0110-23
 23 cm / 9"
 Curved

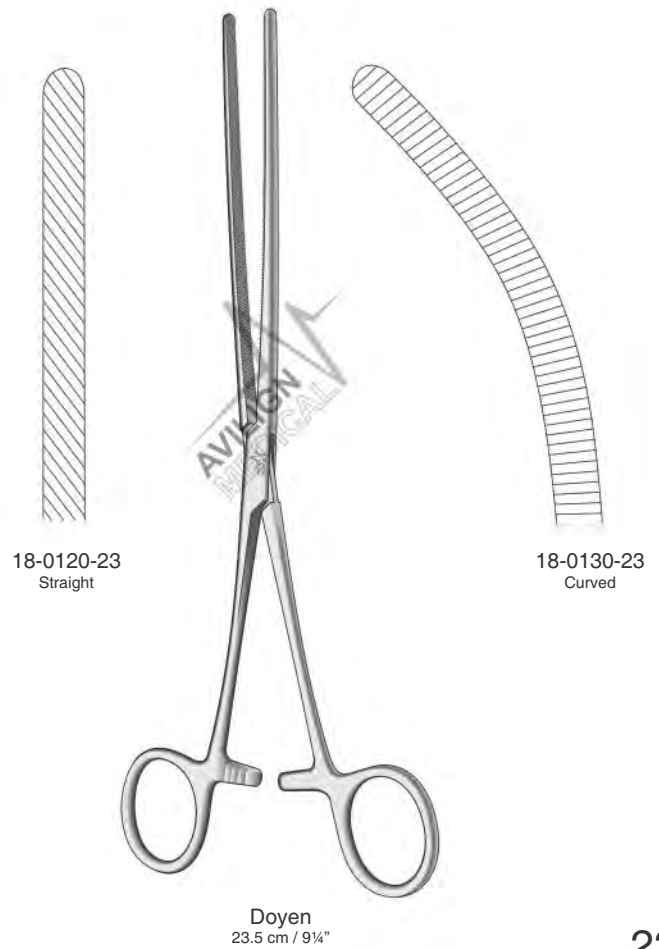

Darmklemmen
 Pinzas Clamps Intestinales
 Pinze Intestinali
 Intestinal Forceps

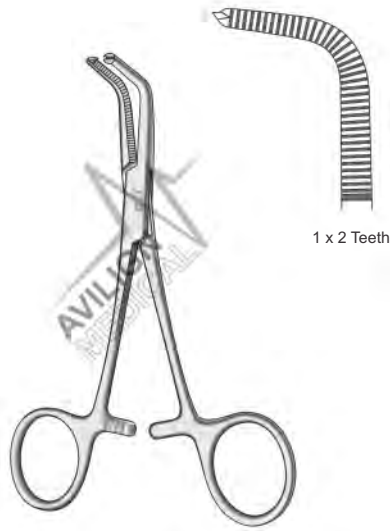

1 x 2 Teeth

Kleinschmidt
 18-0200-13
 13 cm / 5"

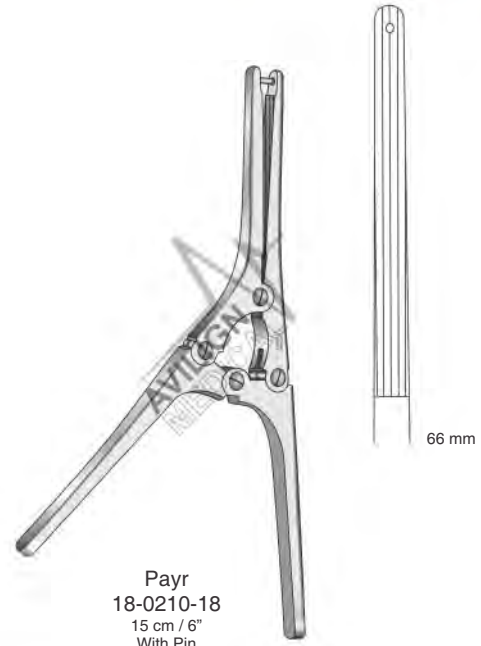

66 mm

Payr
 18-0210-18
 15 cm / 6"
 With Pin

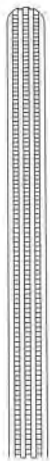

18-0220-23
 Straight

Alarma
 Instrument



Doyen
 23.5 cm / 9 1/4"

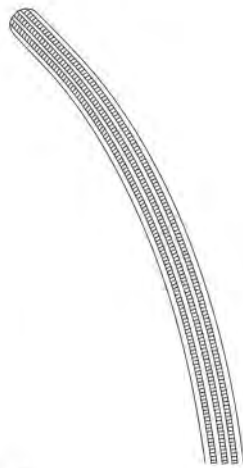

18-0230-23
 Curved

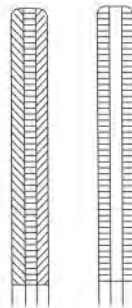

18-0240-25
 Straight

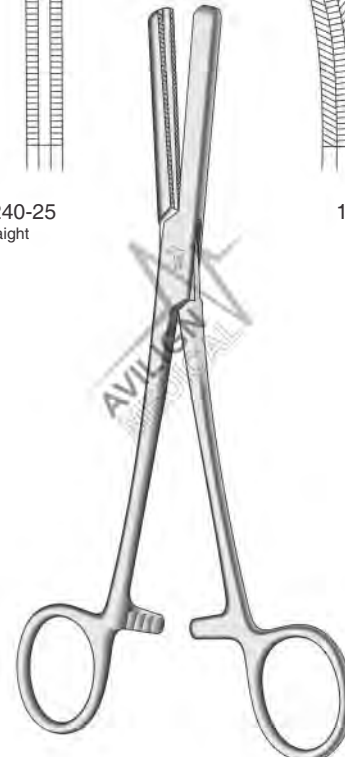

Fergusson
 20 cm / 6 3/4"

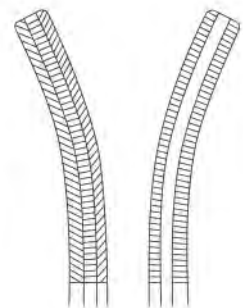

18-0250-26
 Curved

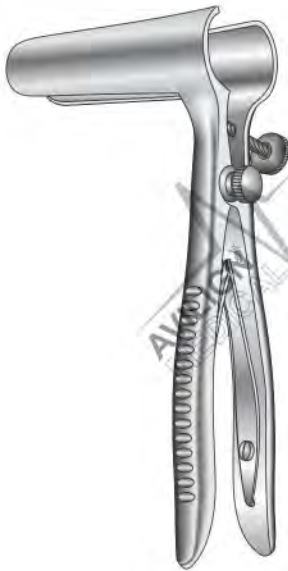

Sims-Bodenhammer
18-0260-15
15.5 cm / 6"

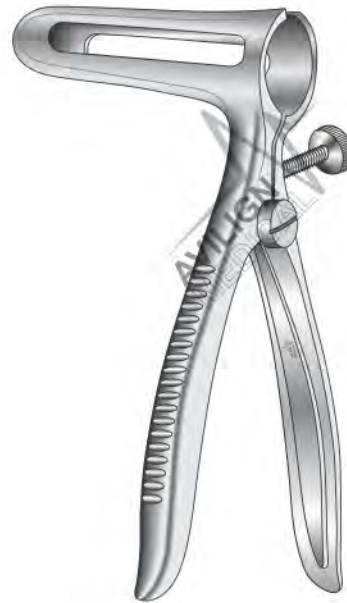

Sims
18-0270-15
15.5 cm / 6"

105 x 23 x 28 mm

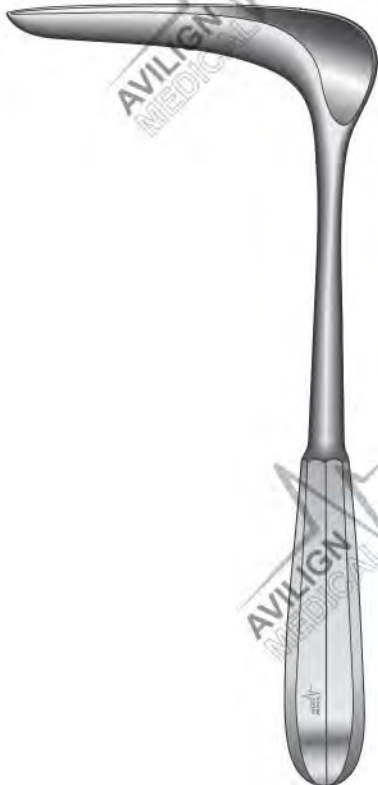

Czerny
18-0280-22
22.5 cm / 9"

80 x 25 mm

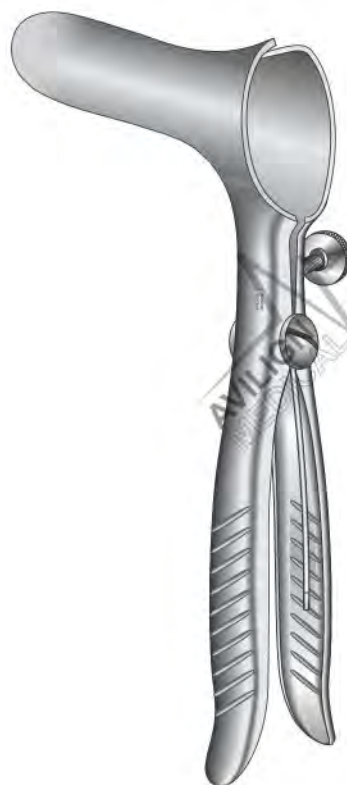

Pratt
18-0290-20
21.5 cm / 8½"

90 x 15 mm



Mathieu
18-0300-21
21 cm / 8¼"

Sphinkteroskope, Analspreizer
 Esfinteroscopios, Separadores Para El Recto
 Sfinteroscopi, Dilatatori Per L'ano Ed Il Retto
 Sphincteroscopes, Rectal Retractors

Max. Spread 110 mm

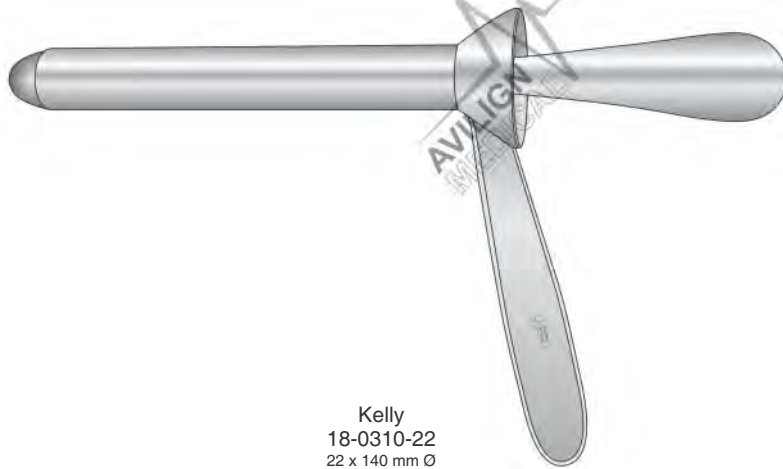

Kelly
 18-0310-22
 22 x 140 mm Ø
 Sphincteroscope

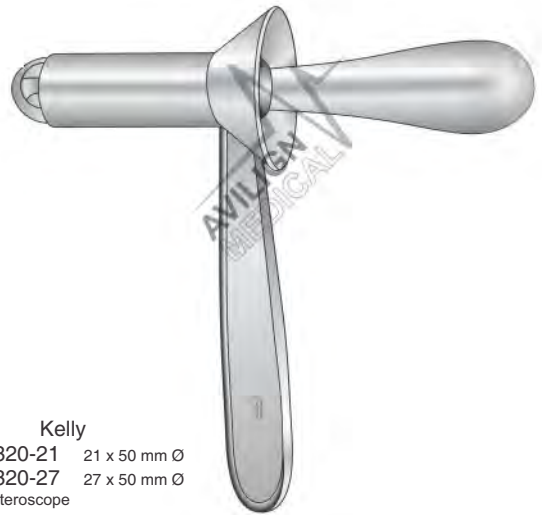

Kelly
 18-0320-21 21 x 50 mm Ø
 18-0320-27 27 x 50 mm Ø
 Sphincteroscope

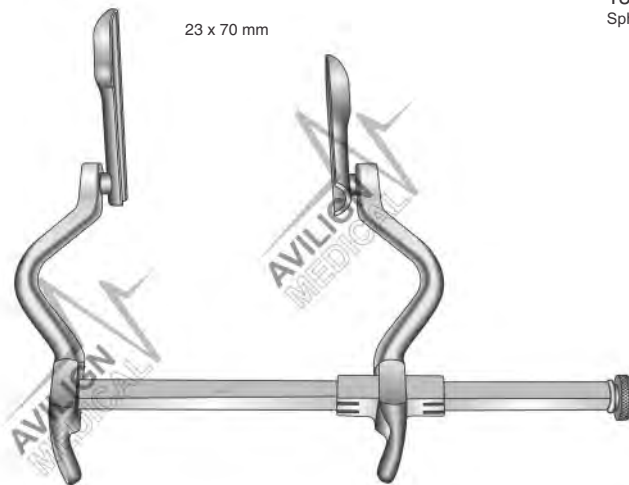

23 x 70 mm

Smith-Buie
 18-0330-00
 15.5 cm / 6"

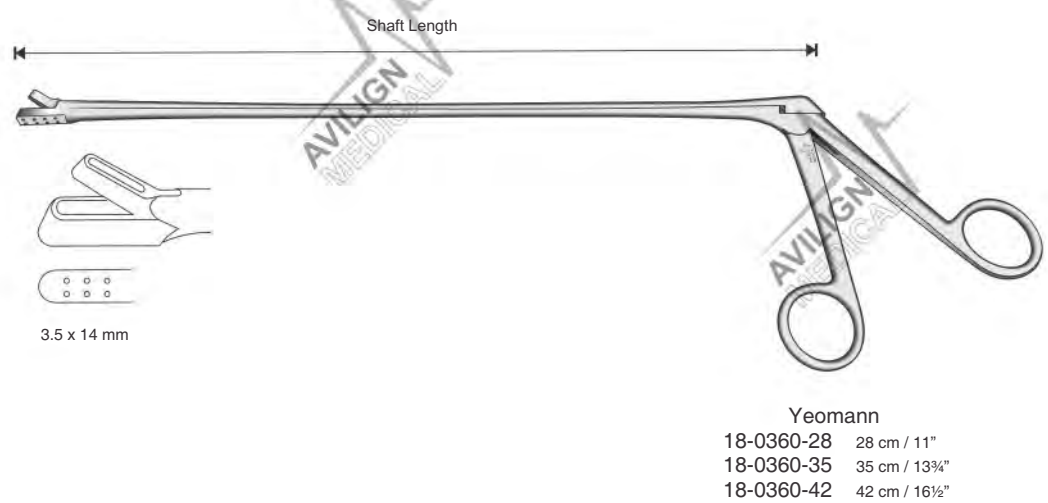
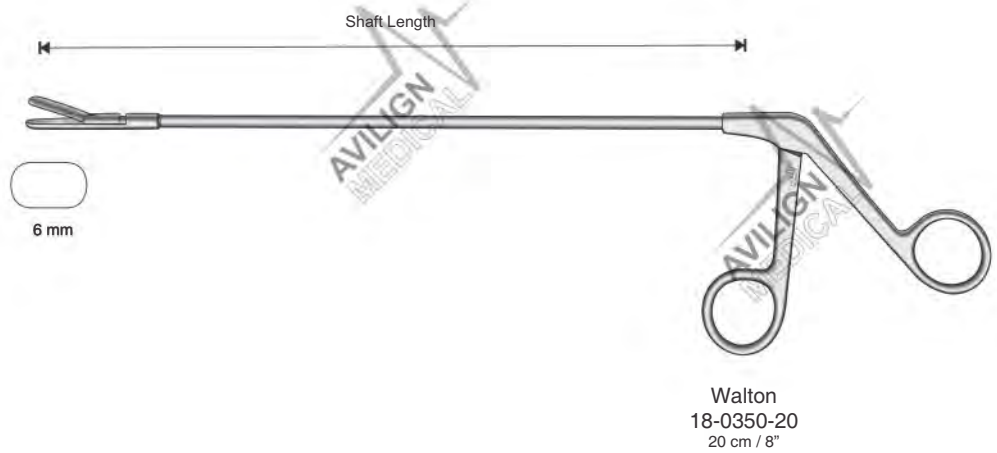
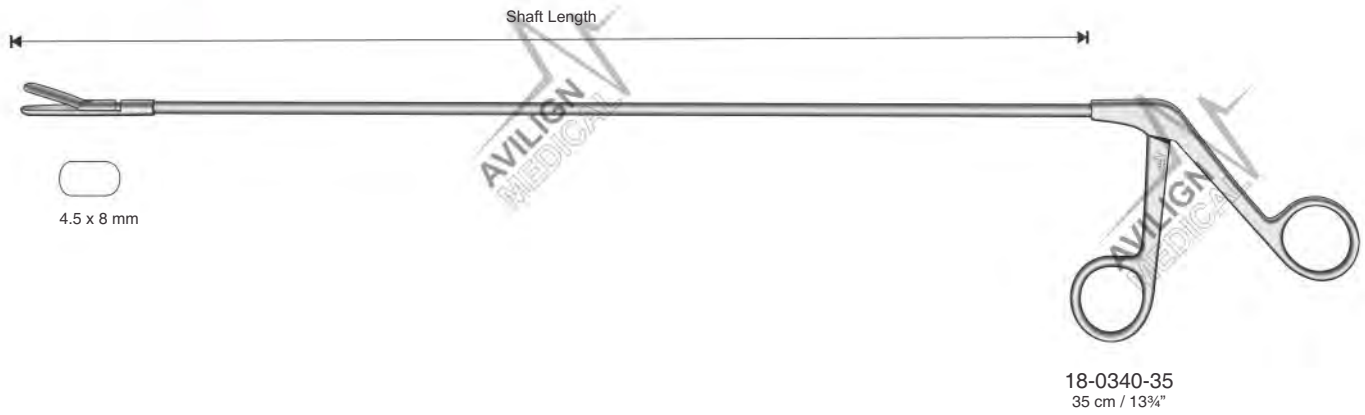

19

Liver

Gall Bladder, Kidney

Leber, Galle, Niere
Hígado, Bilis, Riñón
Fetago, Biliari, Renali

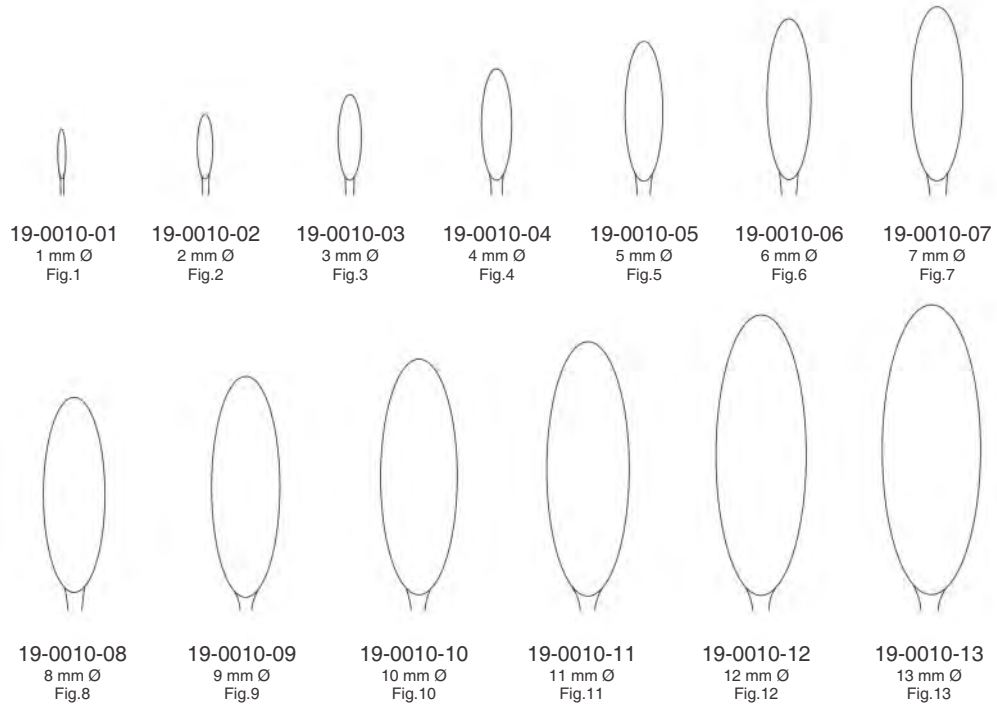

Bakes
 31 cm / 12¼"
 Malleable Shaft

19-0010-20 = Set of 9 ; 19-0010-03 to 19-0010-11
 19-0010-30 = Set of 13 ; 19-0010-01 to 19-0010-13

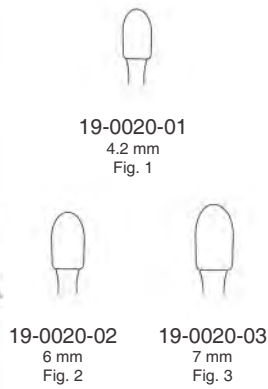

Desjardins
 28 cm / 11"
 Flexible

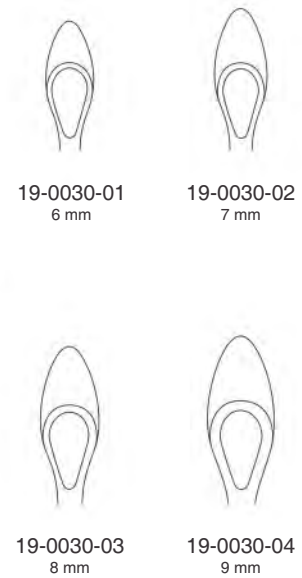

Desjardins
 30 cm / 11¾"
 Flexible

Gallensteinlöffel
 Cucharas Para Cálculos Biliares
 Cucchiari Per Calcoli Biliari
 Gall Stone Scoops

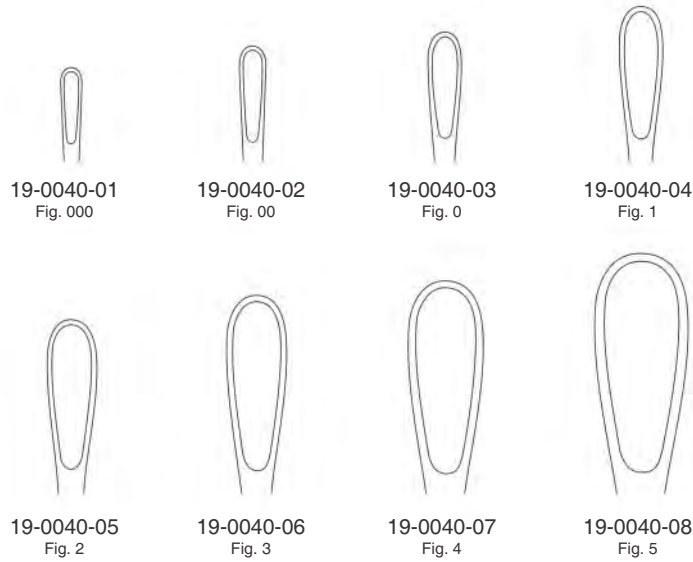

Luer-Koerte
 31 cm / 12¼"
 Malleable



Mayo
 19-0050-28
 28 cm / 11"

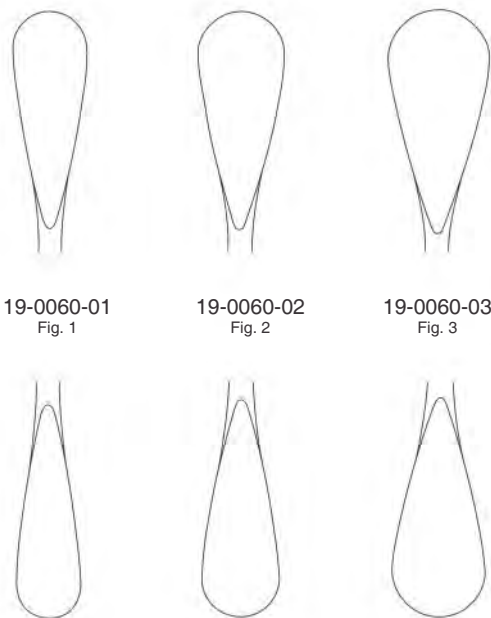

Fergusson
 22 cm / 8¾"

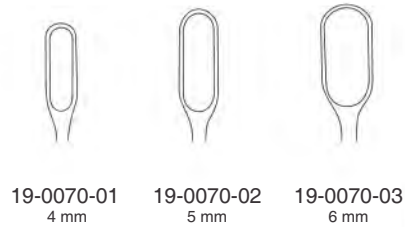

Mayo
 27 cm / 10¾"

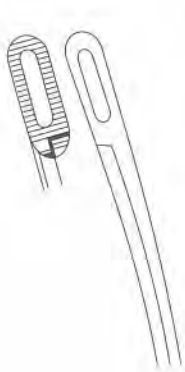

19-0080-01
23 cm / 9"
Fig. 1

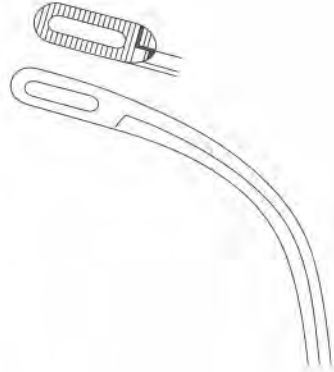

19-0080-02
22 cm 8¾"
Fig. 2

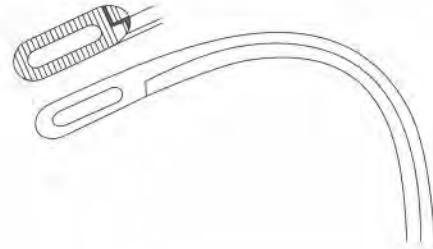

19-0080-03
22 cm 8¾"
Fig. 3

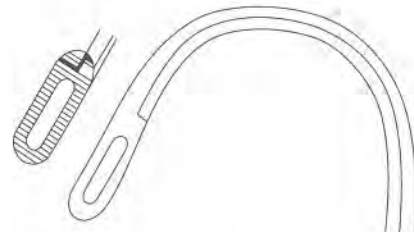

19-0080-04
22 cm 8¾"
Fig. 4

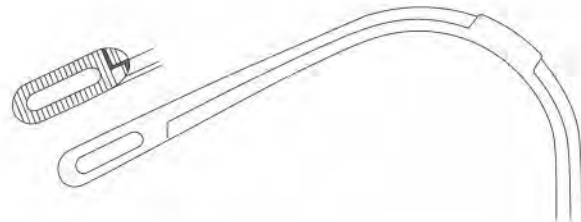

19-0080-05
19 cm / 7½"
Fig. 5

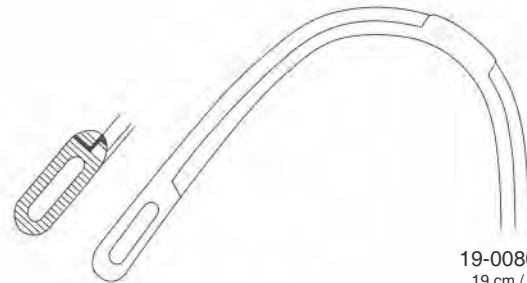

19-0080-06
19 cm / 7½"
Fig. 6



Randall

Nierenfistelzangen, Gallensteinzangen
Pinzas Para Nefrostomía, Pinzas Para Los Cálculos Biliares
Pinze Per Nefrostomia, Pinze Per Calcoli Biliari
Nephrostomy Forceps, Gall Stone Forceps

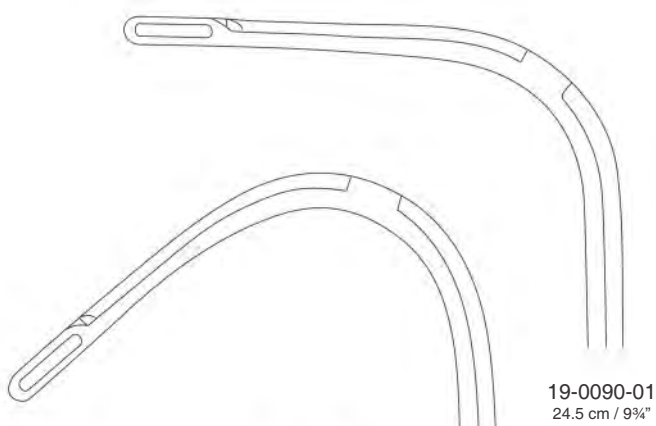

19-0090-01
24.5 cm / 9 3/4"

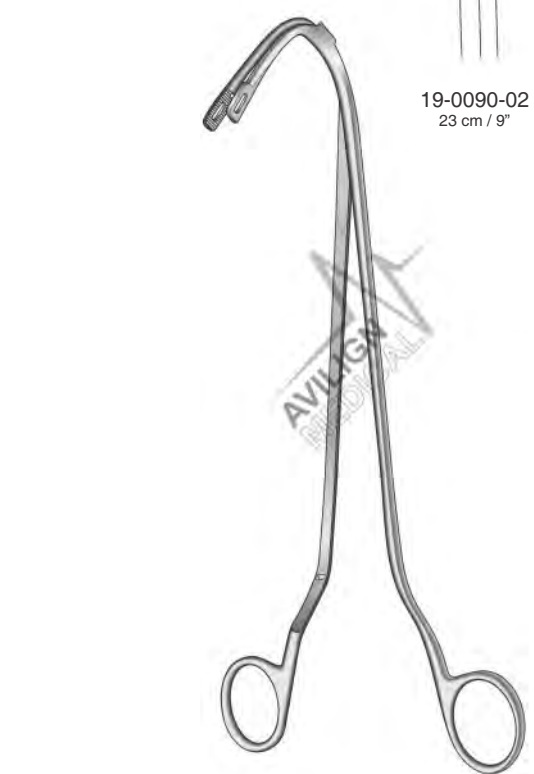

19-0090-02
23 cm / 9"

Randall

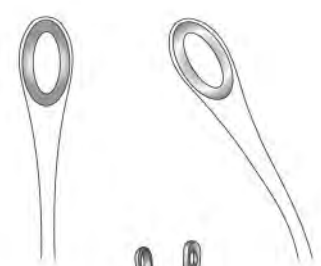

19-0100-20
Straight

19-0110-20
Curved



Blake
20 cm / 8"



Mixer
19-0120-22
22 cm / 8¾"



19-0130-01



19-0130-02



Desjardins
23 cm / 9"



19-0140-01

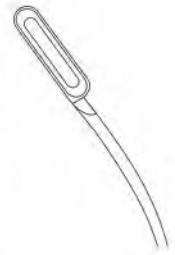

19-0140-02



Desjardins
Very Slender Pattern
23 cm / 9"



20

Gynaecology, Obstetrics

Gynäkologie, Geburtshilfe

Ginecologia, Obstetricia

Ginecologia, Ostetricia



Collin
20-0010-01
55 x 10 mm
For Children

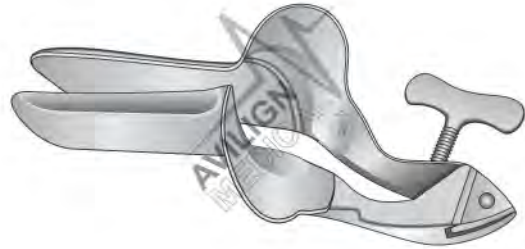

Collin
20-0020-01 85 x 30 mm
20-0020-02 100 x 35 mm
20-0020-03 110 x 40 mm

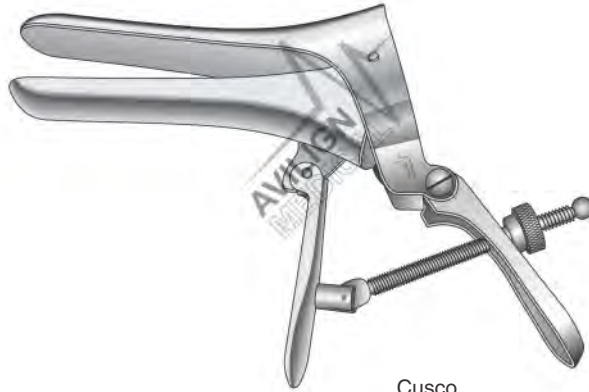

Cusco
20-0030-01
75 x 17 mm
Central Fixation Screw

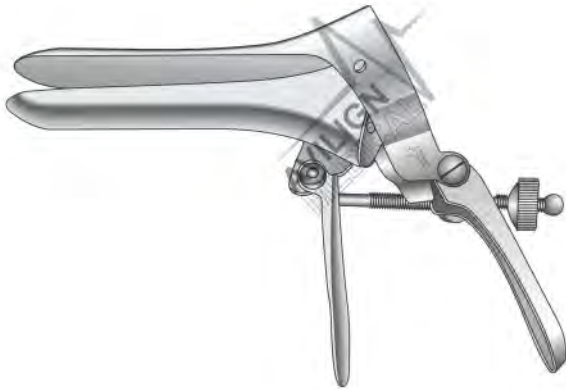

Cusco Standard
20-0040-00 80 x 24 mm
20-0040-01 75 x 32 mm
20-0040-02 85 x 35 mm
20-0040-03 110 x 37 mm
Swiss Pattern
Lateral Fixation Screw



Cusco
20-0050-01 75 x 32 mm
20-0050-02 85 x 35 mm
20-0050-03 110 x 37 mm
Central Fixation Screw

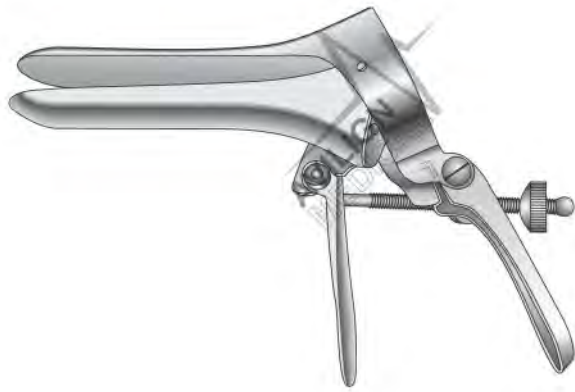

Cusco
 20-0060-01 80 x 22 mm
 20-0060-02 100 x 25 mm
 20-0060-03 105 x 27 mm
 Lateral Fixation Screw



Cusco
 20-0070-01 80 x 32 mm
 20-0070-02 90 x 37 mm
 20-0070-03 115 x 37 mm
 Lateral Fixation Screw

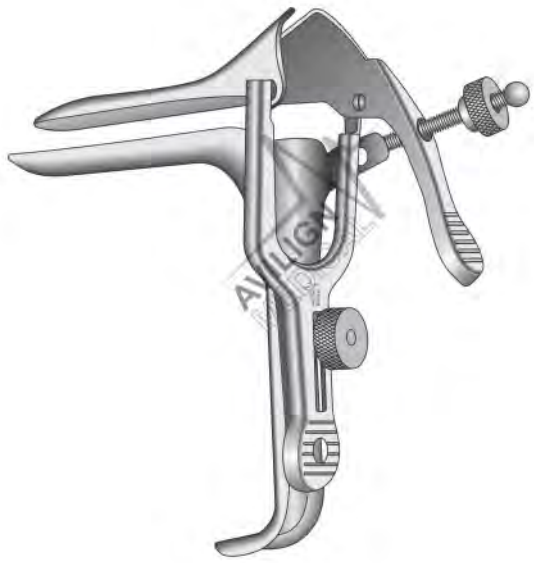

Grave
 20-0080-01 75 x 20 mm
 20-0080-02 95 x 35 mm
 20-0080-03 115 x 35 mm
 Lateral Fixation Screw



Pederson
 20-0090-01 75 x 13 mm
 20-0090-02 100 x 22 mm
 20-0090-03 120 x 25 mm
 Lateral Fixation Screw



Sims

- 20-0100-01 70 x 30 / 65 x 25
- 20-0100-02 70 x 35 / 70 x 30
- 20-0100-03 90 x 40 / 85 x 35



Seidl

- | | | |
|------------|------------|------------|
| 20-0110-01 | 20-0120-01 | 80 x 8 mm |
| 20-0110-02 | 20-0120-02 | 80 x 10 mm |
| 20-0110-03 | 20-0120-03 | 90 x 14 mm |
| Speculum | Retractor | |



Jackson

- 20-0130-01 75 x 35 mm
- 20-0130-02 90 x 35 mm
- 20-0130-03 100 x 35 mm



Kristeller

- 20-0140-00 = 20-0150-01 & 20-0160-01
 - 20-0140-01 = 20-0150-02 & 20-0160-02
 - 20-0140-02 = 20-0150-03 & 20-0160-03
 - 20-0140-03 = 20-0150-04 & 20-0160-04
- Sets = Specula & Retractor

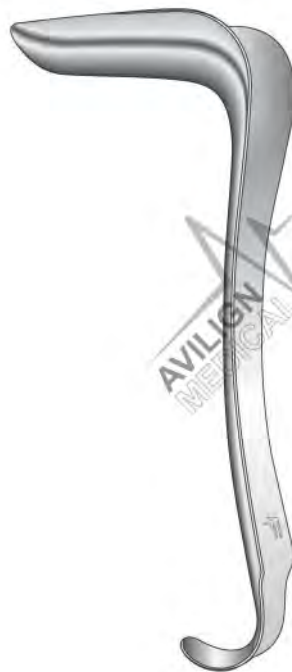

Kristeller

- 20-0150-01 70 x 15 mm
 - 20-0150-02 70 x 27 mm
 - 20-0150-03 80 x 30 mm
 - 20-0150-04 90 x 36 mm
- Specula Only



Kristeller

- 20-0160-01 70 x 15 mm
 - 20-0160-02 75 x 23 mm
 - 20-0160-03 85 x 26 mm
 - 20-0160-04 100 x 32 mm
- Retractor Only

Scheidenspekula
 Espéculos Vaginales
 Speculi Vaginali
 Vaginal Specula



Mathieu
 20-0170-01
 95 x 17-30 mm
 Specula only



Doyen
 20-0180-01 60 x 45 mm
 20-0180-02 90 x 45 mm
 20-0180-03 112 x 45 mm



Doyen
 20-0190-01 60 x 30 mm
 20-0190-02 70 x 30 mm
 20-0190-03 80 x 30 mm

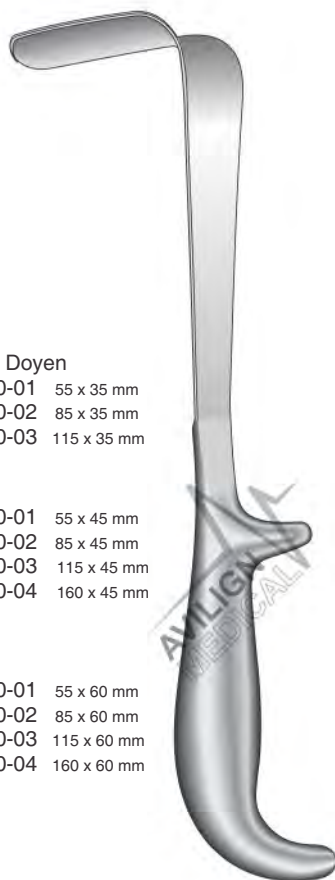

Doyen
 20-0200-01 55 x 35 mm
 20-0200-02 85 x 35 mm
 20-0200-03 115 x 35 mm

20-0210-01 55 x 45 mm
 20-0210-02 85 x 45 mm
 20-0210-03 115 x 45 mm
 20-0210-04 160 x 45 mm

20-0220-01 55 x 60 mm
 20-0220-02 85 x 60 mm
 20-0220-03 115 x 60 mm
 20-0220-04 160 x 60 mm



Breisky
 20-0230-01 100 x 15 mm
 20-0230-02 100 x 20 mm
 20-0230-03 100 x 25 mm
 20-0230-04 100 x 30 mm
 20-0230-05 100 x 35 mm
 20-0230-06 100 x 40 mm

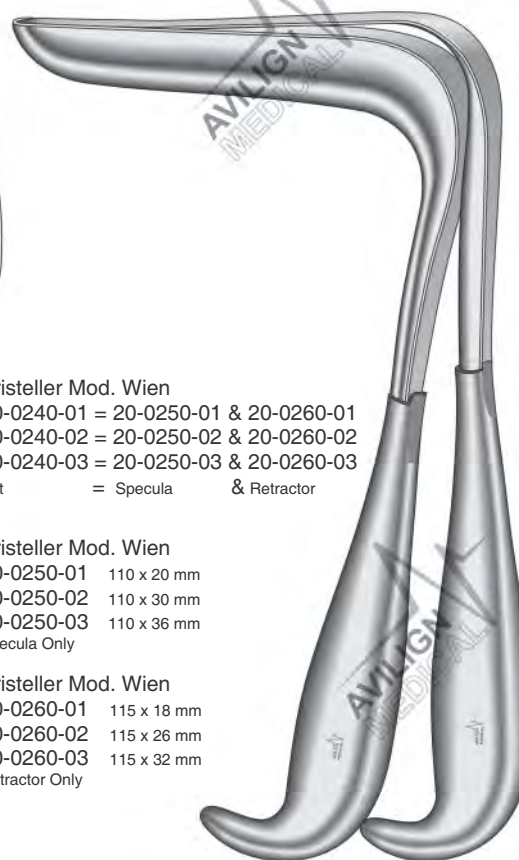

Kristeller Mod. Wien
 20-0240-01 = 20-0250-01 & 20-0260-01
 20-0240-02 = 20-0250-02 & 20-0260-02
 20-0240-03 = 20-0250-03 & 20-0260-03
 Set = Specula & Retractor

Kristeller Mod. Wien
 20-0250-01 110 x 20 mm
 20-0250-02 110 x 30 mm
 20-0250-03 110 x 36 mm
 Specula Only

Kristeller Mod. Wien
 20-0260-01 115 x 18 mm
 20-0260-02 115 x 26 mm
 20-0260-03 115 x 32 mm
 Retractor Only



Auvard
20-0270-00
83 x 38 mm
With Fixed Weight



Auvard
20-0280-01 80 x 38 mm
20-0280-02 102 x 45 mm
With Detachable Weight

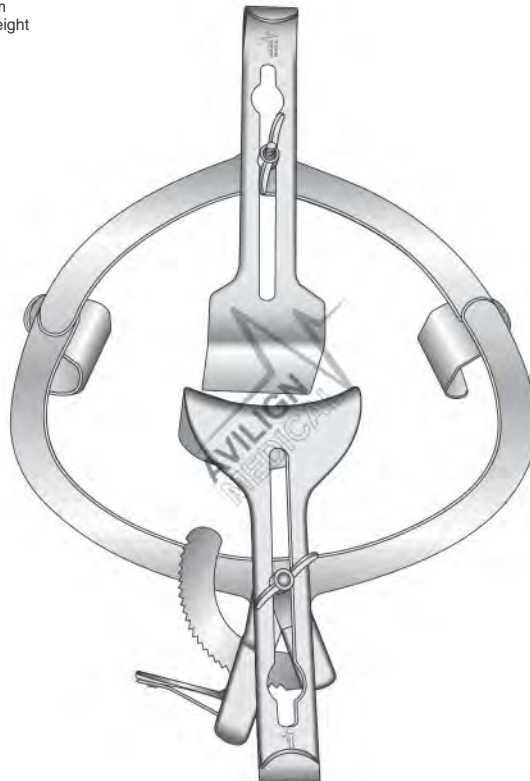

O'Sullivan - O'Conner
20-0290-00
Complete With 2 Rotatable Blades 25 x 60 mm
And Blades 45 x 85 mm / 70 x 105 mm

Uterus-dilatatore
 Dilatadores Uterinos
 Dilatatori Uterini
 Uterine Dilators



Hegar

20-0300-01	Ø 1 mm
20-0300-02	Ø 2 mm
20-0300-03	Ø 3 mm
20-0300-04	Ø 4 mm
20-0300-05	Ø 5 mm
20-0300-06	Ø 6 mm
20-0300-07	Ø 7 mm
20-0300-08	Ø 8 mm
20-0300-09	Ø 9 mm
20-0300-10	Ø 10 mm
20-0300-11	Ø 11 mm
20-0300-12	Ø 12 mm
20-0300-13	Ø 13 mm
20-0300-14	Ø 14 mm
20-0300-15	Ø 15 mm

Hegar

20-0300-16	Ø 16 mm
20-0300-17	Ø 17 mm
20-0300-18	Ø 18 mm
20-0300-19	Ø 19 mm
20-0300-20	Ø 20 mm
20-0300-21	Ø 21 mm
20-0300-22	Ø 22 mm
20-0300-23	Ø 23 mm
20-0300-24	Ø 24 mm
20-0300-25	Ø 25 mm
20-0300-26	Ø 26 mm
20-0300-27	Ø 27 mm
20-0300-28	Ø 28 mm
20-0300-29	Ø 29 mm
20-0300-30	Ø 30 mm

Hegar

20-0310-01	Ø 1.5 mm
20-0310-02	Ø 2.5 mm
20-0310-03	Ø 3.5 mm
20-0310-04	Ø 4.5 mm
20-0310-05	Ø 5.5 mm
20-0310-06	Ø 6.5 mm
20-0310-07	Ø 7.5 mm
20-0310-08	Ø 8.5 mm
20-0310-09	Ø 9.5 mm
20-0310-10	Ø 10.5 mm
20-0310-11	Ø 11.5 mm
20-0310-12	Ø 12.5 mm
20-0310-13	Ø 13.5 mm
20-0310-14	Ø 14.5 mm
20-0310-15	Ø 15.5 mm
20-0310-16	Ø 16.5 mm
20-0310-17	Ø 17.5 mm
20-0310-18	Ø 18.5 mm
20-0310-19	Ø 19.5 mm



Hegar

20-0320-14	4 mm - 17 mm	Set Of 14
20-0320-15	4 mm - 17 mm	Metal Case & Rack, Only
20-0320-16	4 mm - 17 mm	Metal Case 205 x 105 x 15 mm, Only
20-0320-20	4 mm - 12 mm	
20-0320-21	13 mm - 17 mm	Rack, Only.

Hegar

20-0330-26	1 mm - 26 mm	Set Of 26
20-0330-27	1 mm - 26 mm	Metal Case & Rack, Only
20-0330-28	1 mm - 26 mm	Metal Case 310 x 210 x 55 mm, Only
20-0330-30	4 mm - 17 mm	
20-0330-31	18 mm - 26 mm	Rack, only



- Hegar
- 20-0340-02 Ø 1,2 mm
 - 20-0340-04 Ø 3,4 mm
 - 20-0340-06 Ø 5,6 mm
 - 20-0340-08 Ø 7,8 mm
 - 20-0340-10 Ø 9,10 mm
 - 20-0340-12 Ø 11,12 mm
 - 20-0340-14 Ø 13,14 mm
 - 20-0340-16 Ø 15,16 mm
 - 20-0340-18 Ø 17,18 mm
 - 20-0340-20 Ø 19,20 mm
 - 20-0340-22 Ø 21,22 mm
 - 20-0340-24 Ø 23,24 mm
 - 20-0340-26 Ø 25,26 mm

- Hegar
- 20-0350-01 Set Containing 3,4 mm to 17,18 mm
 - 20-0350-02 Set Containing 1,2 mm to 25,26 mm



Hegar
20-0360-00
3,4 mm to 17,18 mm
Set in Canvas Pouch

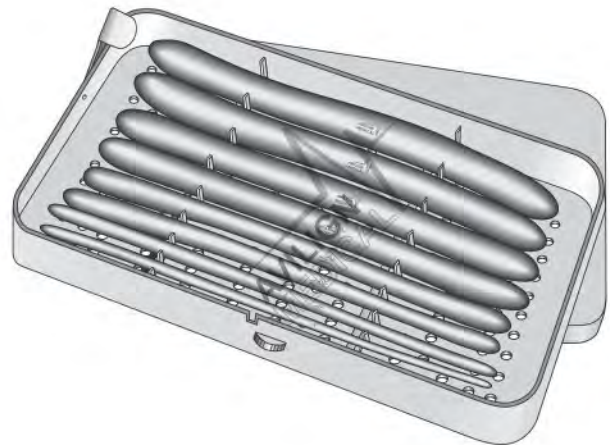

Hegar
20-0370-00
1,2 mm to 25,26 mm
Set in Metal Case

Uterussonden, Uterus-depressor
 Hosterómetros, Depresores Uterinos
 Isterometri, Depressori Uterini
 Uterine Probes, Uterine Depressor



Braun
 20-0380-26
 28 cm / 11"
 Uterine Depressor

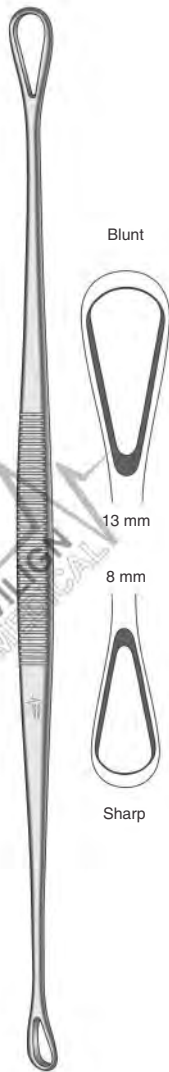

Blake
 20-0390-27
 28 cm / 11"
 Uterine Curette



Sims
 20-0400-32 Rigid, Stainless Steel
 20-0401-32 Rigid, Chrome Plated
 20-0410-32 Malleable, Stainless Steel
 20-0411-32 Malleable, Chrome Plated
 32 cm / 12½"



20-0420-32 Rigid, Stainless Steel
 20-0421-32 Rigid, Chrome Plated
 20-0430-32 Malleable, Stainless Steel
 20-0431-32 Malleable, Chrome Plated
 32 cm / 12½"



Valleix
 20-0440-25
 29.5 cm / 11½"

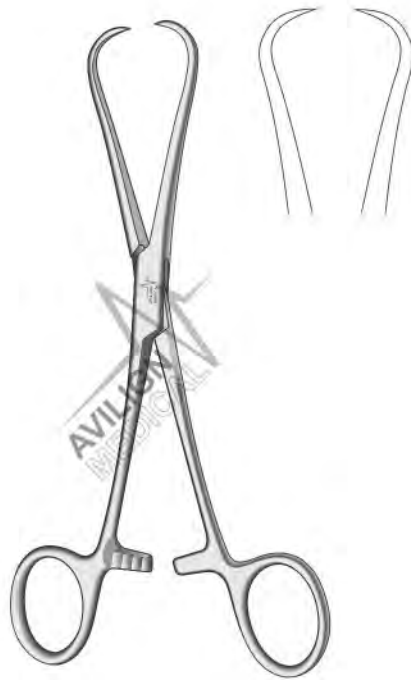

Staude-Moore
20-0450-17
17 cm / 6¾"



Schroeder
20-0460-25
25 cm / 9¾"



Braun
20-0470-25
25 cm / 9¾"

Hakenzangen
Pinzas Para Coger El Cuello De Útero
Pinze Per Abbassare Il Collo Dell' Utero
Uterine Tenaculum Forceps



20-0480-24
Straight



20-0490-24
Curved



Schroeder
24 cm / 9½"

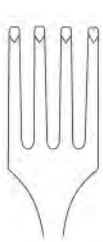

Czerny
20-0500-21
20.5 cm / 8"



Pozzi
20-0510-18
18 cm / 7"



Museux
20-0520-20
20 cm / 8"



Jacobs
20-0530-21
21 cm / 8 1/4"



Beacham
20-0540-26
26 cm / 10 1/4"
Amniotome

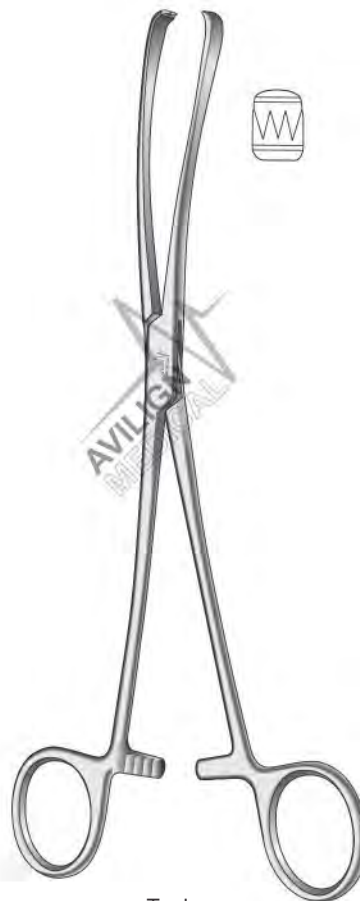

Teale
20-0550-18 18 cm / 7"
20-0550-23 23 cm / 9"
3 x 4 Teeth

Uterusfßnzangen, Myomheber
Pinzas para el útero, Tirabuzóns para mioma
Pinze per afferrare l' utero, Succhielli per fibroma
Uterine Grasping Forceps, Myoma Screws



Doyen
20-0560-17
16.5 cm / 6½"
Ø 25 mm



Lahey
20-0570-15
15 cm / 6"

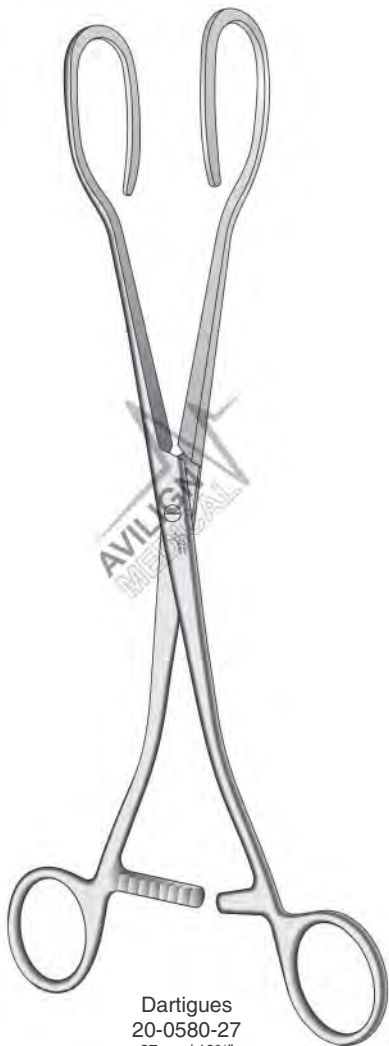

Dartigues
20-0580-27
27 cm / 10¾"

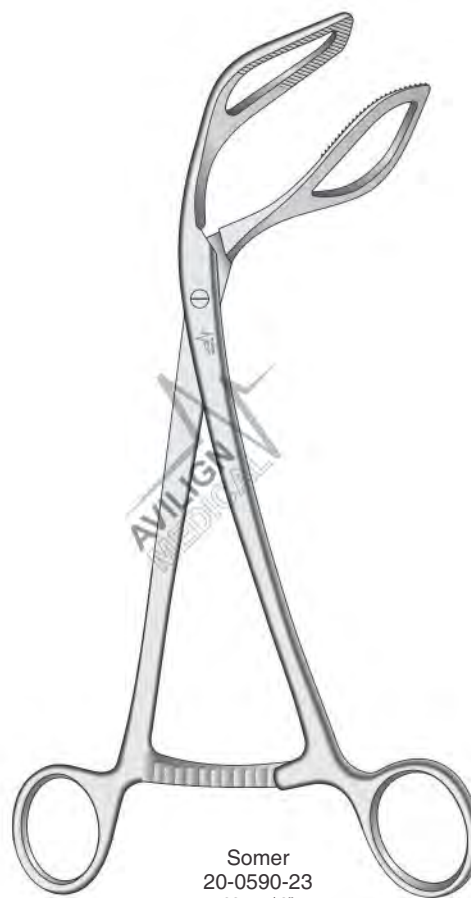

Sommer
20-0590-23
23 cm / 9"

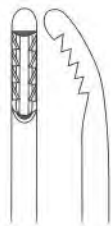

- 20-0600-01 Ø 1 mm
- 20-0600-02 Ø 2 mm
- 20-0600-03 Ø 3 mm
- 20-0600-04 Ø 4 mm



Novak
23 cm / 9"

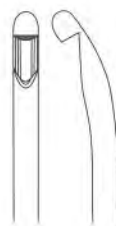

- 20-0610-04
Ø 4.0 mm



Randall
25 cm / 9¾"



- 20-0620-03
3 mm



- 20-0630-03
3 mm



Kevorkian
30 cm / 11¾"

Uterus-biopsiezangen
 Pinzas Sacabocados Para Biopsia
 Pinze Per La Biopsia Cervicale E Da Prelievo
 Cervical Biopsy & Specimen Forceps

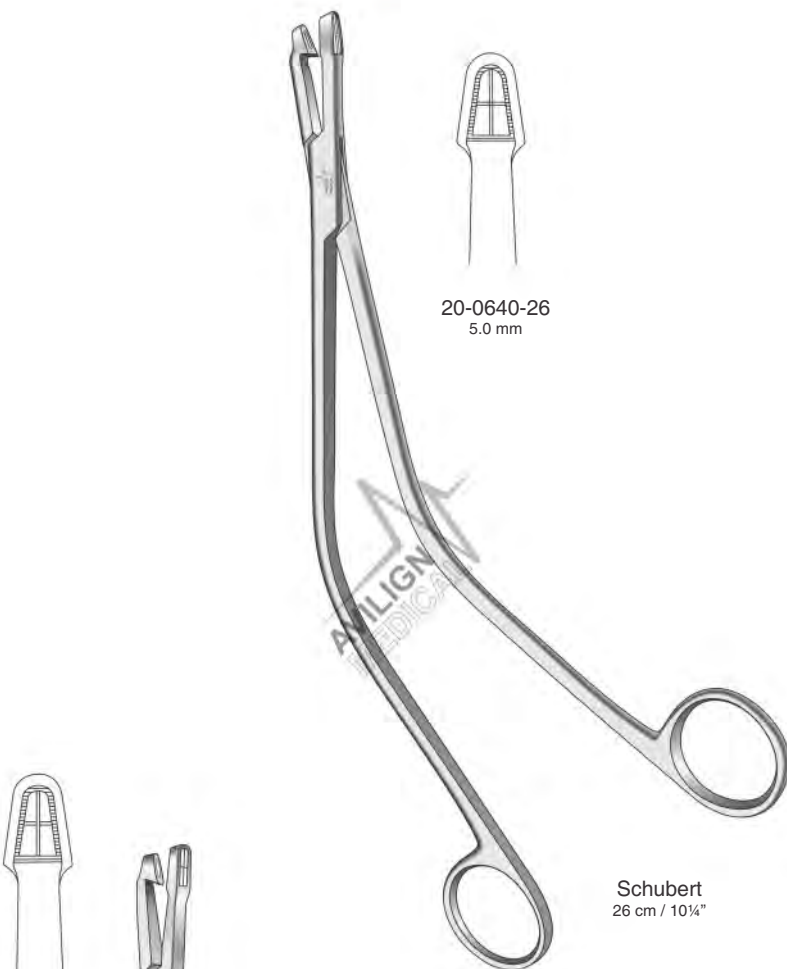

20-0640-26
 5.0 mm



4.8 mm

Schubert
 20-0650-21
 21 cm / 8¼"

20-0650-24
 29 cm / 11¼"

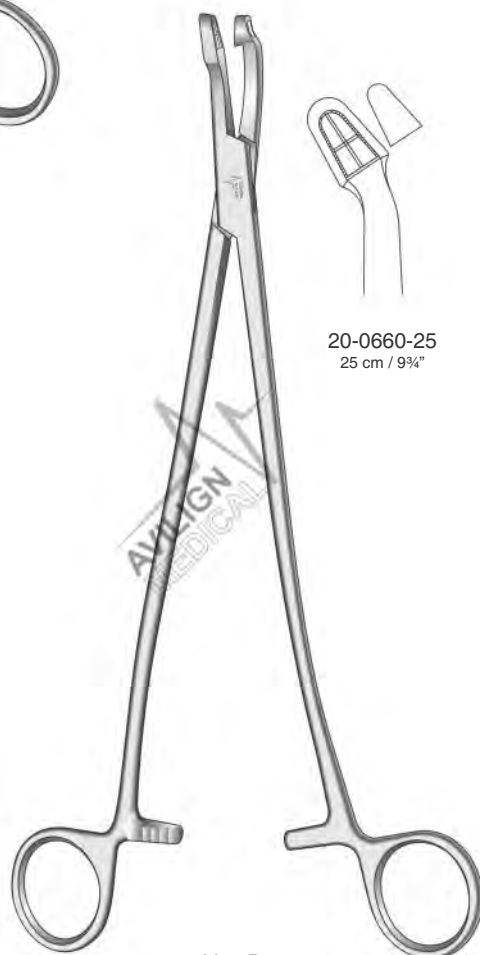

20-0660-25
 25 cm / 9¾"

Van Doren

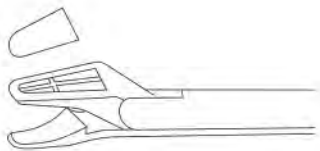
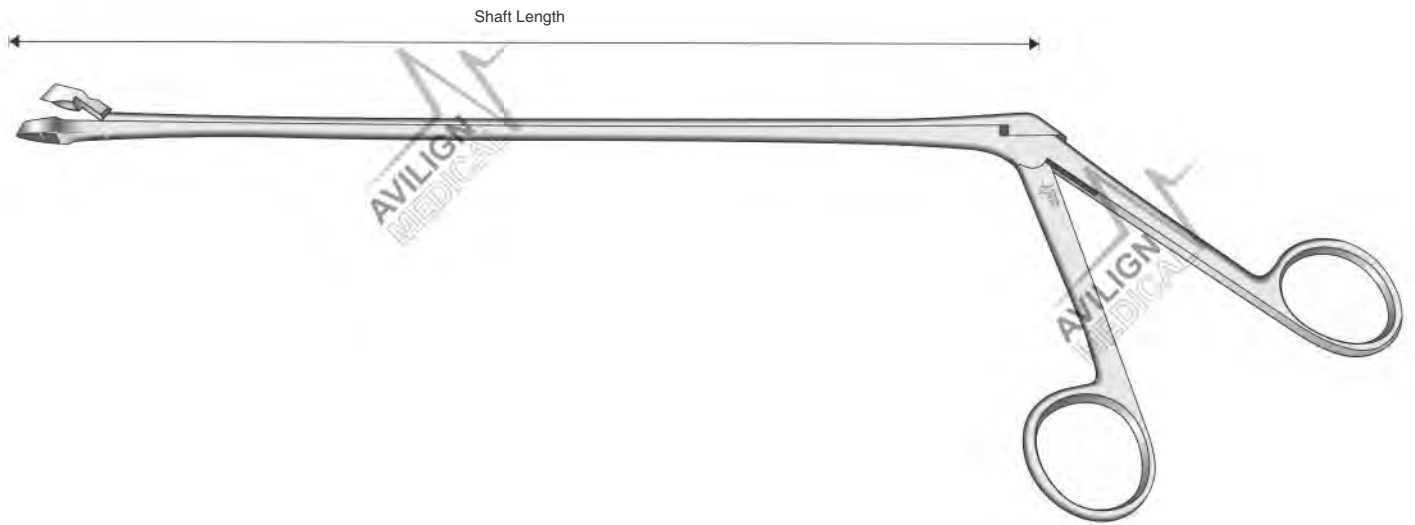

Alexander
20-0670-20
20 cm / 8"

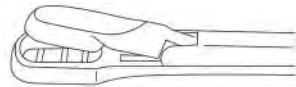

Douay
20-0680-20 20 cm / 8"
20-0680-25 25 cm / 9 3/4"
20-0680-30 30 cm / 11 3/4"
20-0680-35 35 cm / 13 3/4"
20-0680-40 40 cm / 16"

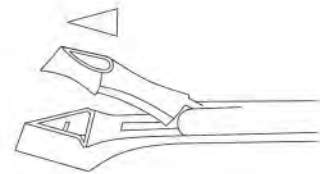

Schumacher
20-0690-24
24 cm / 9 1/4"

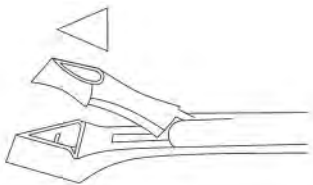

Schumacher
20-0700-24
24 cm / 9 1/4"

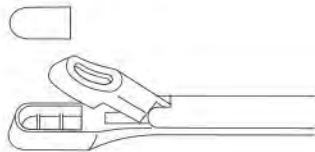

Eppendorf
20-0710-20 20 cm / 8"
20-0710-23 23 cm / 9"

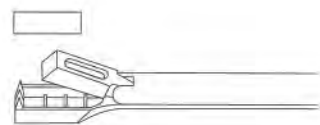

Kevorkian
20-0720-20 20 cm / 8"
20-0720-23 23 cm / 9"
20-0720-25 25 cm / 9 3/4"

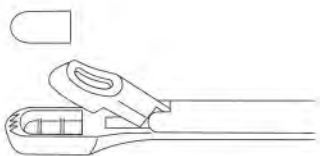

Wittner
20-0730-23
23 cm / 9"

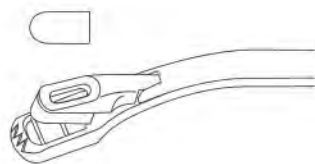

Wittner
20-0740-23
23 cm / 9"

Uterus-biopsiezangen
 Pinzas Saca-bocados Para Biopsia
 Pinze Per La Biopsia Cervicale e Da Prelievo
 Cervical Biopsy & Specimen Forceps

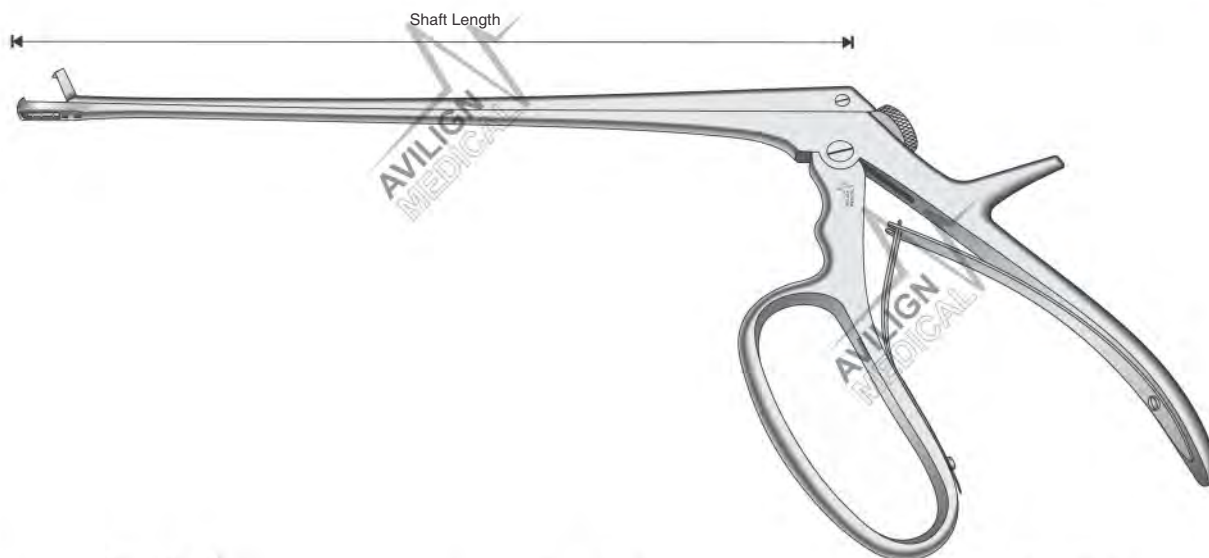

Tischler-Kevorkian
 20-0750-22
 22 cm / 8¾"
 With Fixing Screw



Kevorkian-Pacific
 20-0760-22
 22 cm / 8¾"
 With Fixing Screw



Tischler
 20-0770-22
 23 cm / 9"
 With Fixing Screw



Baby-Tischler
 20-0780-20
 20 cm / 8"
 With Fixing Screw



Baby-Tischler
 20-0790-20
 20 cm / 8"
 Without Fixing Screw



Tischler-Morgan
 20-0800-22
 22 cm / 8¾"
 Without Fixing Screw

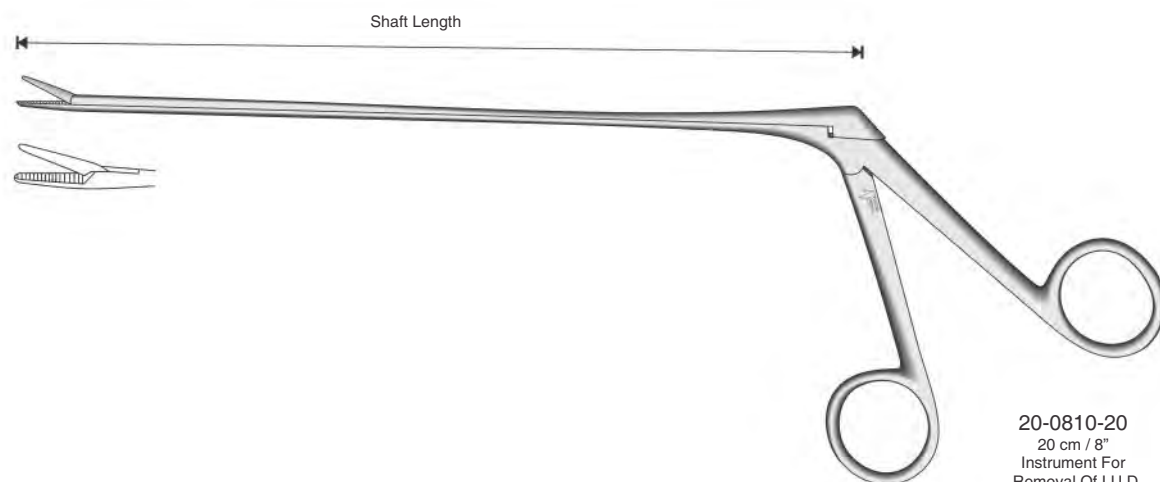

20-0810-20
 20 cm / 8"
 Instrument For
 Removal Of I.U.D

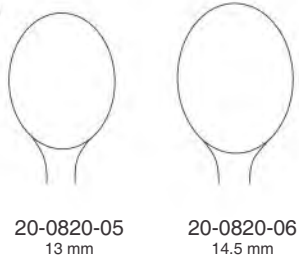
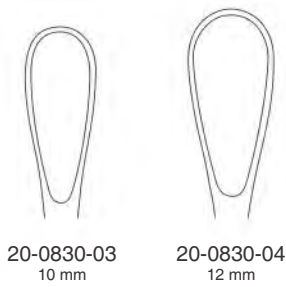
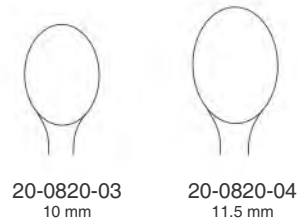
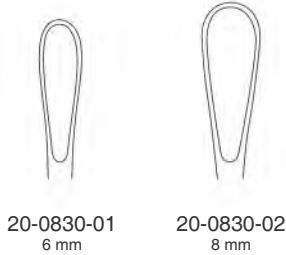
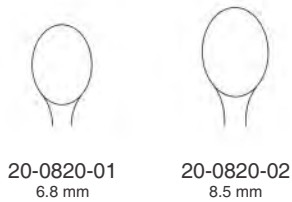

Schroeder
30 cm / 11 3/4"
Sharp, Rigid



Gourdet
28 cm / 11"
Blunt, Rigid

Uterusküretten
 Curetas Uterinas
 Curette Uterine
 Uterine Curettes



20-0840-01
 Sharp, Rigid
 7.5 mm
 Fig. 1



20-0850-01
 Sharp, Malleable
 7.5 mm
 Fig. 1



20-0860-01
 Blunt, Rigid
 7.5 mm
 Fig. 1



20-0840-02
 Sharp, Rigid
 8.5 mm
 Fig. 2



20-0850-03
 Sharp, Malleable
 8.5 mm
 Fig. 2



20-0860-02
 Blunt, Rigid
 8.5 mm
 Fig. 2



20-0840-03
 Sharp, Rigid
 10.5 mm
 Fig. 3



20-0850-03
 Sharp, Malleable
 10.5 mm
 Fig. 3



20-0860-03
 10.5 mm
 Fig. 3



20-0840-04
 Sharp, Rigid
 12 mm
 Fig. 4



20-0850-04
 Sharp, Malleable
 12 mm
 Fig. 4



20-0860-04
 12 mm
 Fig. 4



20-0840-05
 Sharp, Rigid
 14 mm
 Fig. 5



20-0850-05
 Sharp, Malleable
 14 mm
 Fig. 5



20-0860-05
 Blunt, Rigid
 14 mm
 Fig. 5



20-0840-06
 Sharp, Rigid
 15 mm
 Fig. 6



20-0850-06
 Sharp, Malleable
 15 mm
 Fig. 6



20-0860-06
 Blunt, Rigid
 15 mm
 Fig. 6



Sims
 26 cm / 10¼"



20-0870-05
Blunt, Rigid



20-0870-06
Blunt, Rigid



20-0870-07
Blunt, Rigid



20-0870-08
Blunt, Rigid



20-0870-09
Blunt, Rigid



20-0870-11
Blunt, Rigid



20-0870-12
Blunt, Rigid



20-0870-14
Blunt, Rigid

20-0880-05
Blunt, Malleable
Fig. 0 / 5 mm

20-0880-06
Blunt, Malleable
Fig. 0 / 6 mm

20-0880-07
Blunt, Malleable
Fig. 1 / 7 mm

20-0880-08
Blunt, Malleable
Fig. 2 / 8 mm

20-0880-09
Blunt, Malleable
Fig. 3 / 9 mm

20-0880-11
Blunt, Malleable
Fig. 4 / 11 mm

20-0880-12
Blunt, Malleable
Fig. 5 / 12 mm

20-0880-14
Blunt, Malleable
Fig. 6 / 14 mm



20-0870-15
Blunt, Rigid



20-0870-16
Blunt, Rigid



20-0870-19
Blunt, Rigid



20-0870-20
Blunt, Rigid



20-0870-21
Blunt, Rigid

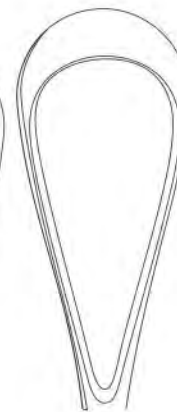

20-0870-23
Blunt, Rigid

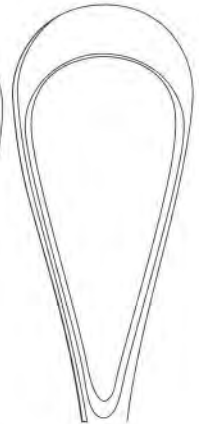

20-0870-25
Blunt, Rigid

20-0880-15
Blunt, Malleable
Fig. 7 / 15 mm

20-0880-16
Blunt, Malleable
Fig. 8 / 16 mm

20-0880-19
Blunt, Malleable
Fig. 9 / 19 mm

20-0880-20
Blunt, Malleable
Fig. 10 / 20 mm

20-0880-21
Blunt, Malleable
Fig. 11 / 21 mm

20-0880-23
Blunt, Malleable
Fig. 12 / 23 mm

20-0880-25
Blunt, Malleable
Fig. 13 / 25 mm

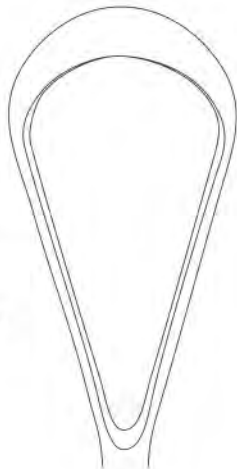

20-0870-30
Blunt, Rigid

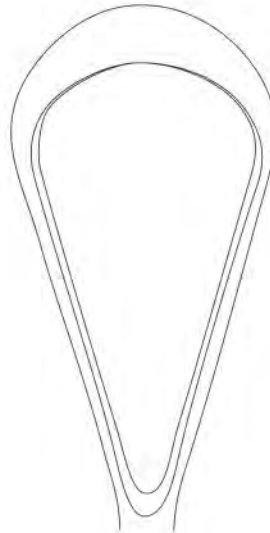

20-0870-35
Blunt, Rigid

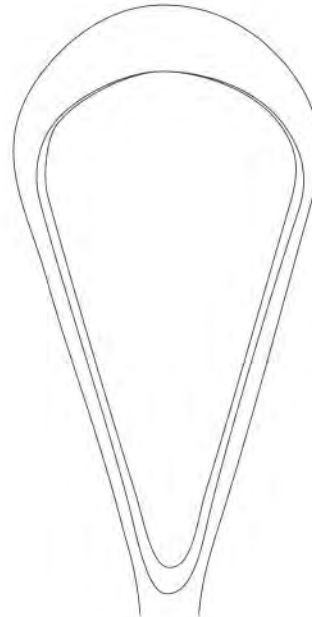

20-0870-40
Blunt, Rigid

20-0880-30
Blunt, Malleable
Fig. 14 / 30 mm

20-0880-35
Blunt, Malleable
Fig. 15 / 35 mm

20-0880-40
Blunt, Malleable
Fig. 16 / 40 mm





Naegele
20-0910-36 36 cm / 14¼"
20-0910-40 40 cm / 16"

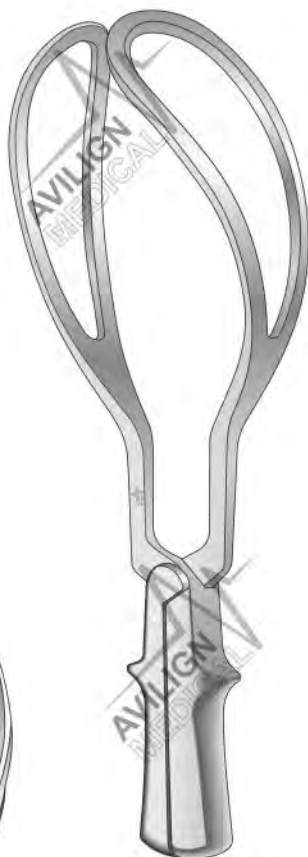

Simpson
20-0890-23
23 cm / 9"



Wrigley
20-0920-25 25 cm / 9¾"
20-0920-29 28 cm / 11"

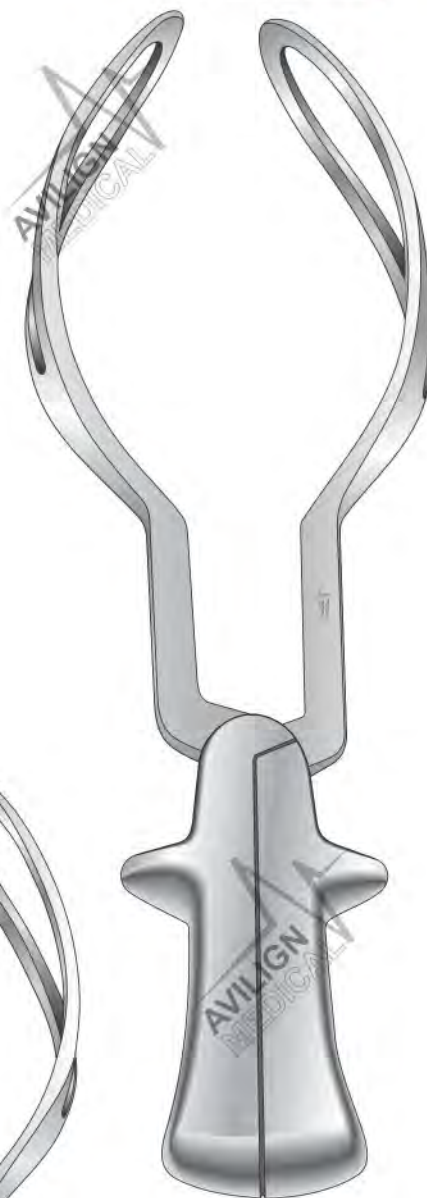

Simpson
20-0900-30
30 cm / 11¾"



Collin
 20-0930-09
 9 cm / 3½"
 Umbilical Cord Clamp



Smellie
 20-0940-25
 25 cm / 9¾"
 Perforator



Braun
 20-0950-30
 30 cm / 11¾"
 Decapitating Hooks

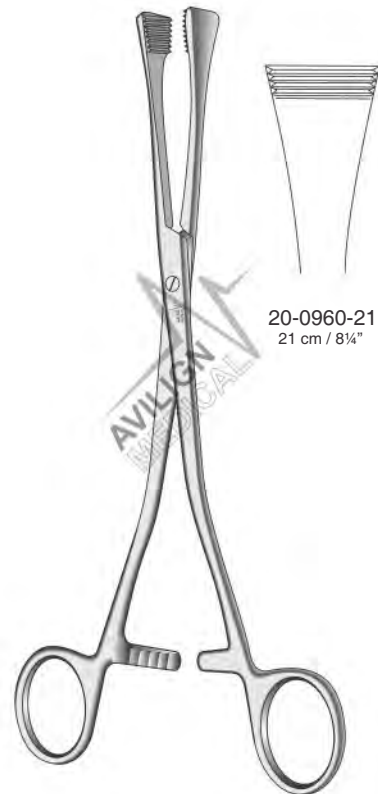

Green-Armytage
 Caesarean Section
 Haemostatic Forceps



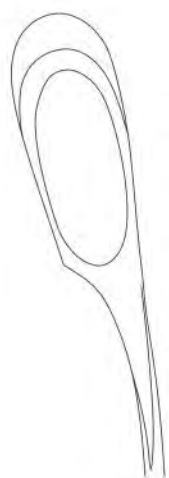

20-0970-28
 28.5 cm / 11¼"



Winter



20-0980-01
 Fig. 1
 Straight

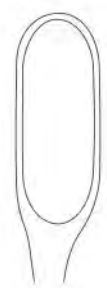

20-0980-02
 Fig. 2
 Straight



20-0980-03
 Fig. 3
 Straight



20-0990-01
 Fig. 1
 Angled



20-0990-02
 Fig. 2
 Angled



20-0990-03
 Fig. 3
 Angled

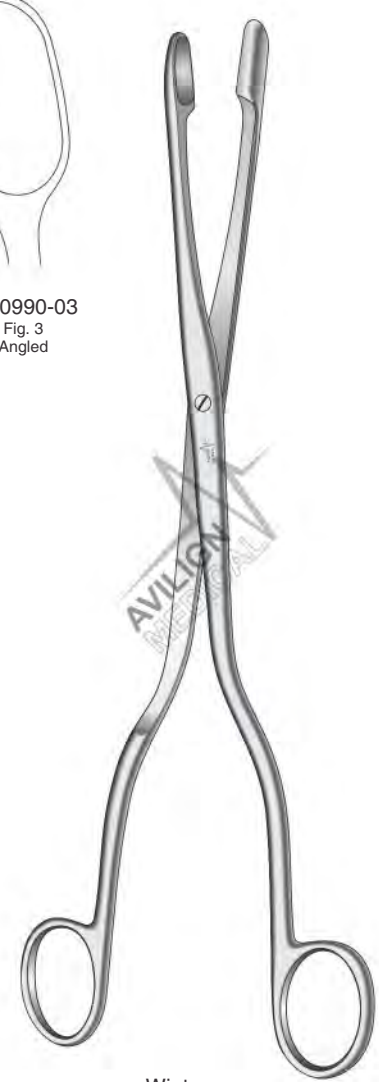

Winter
 28 cm / 11"

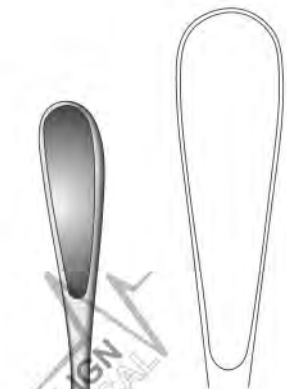
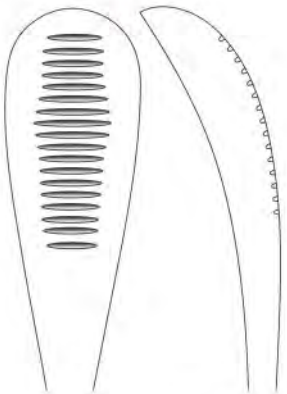

20-1000-14
14.5 mm



20-1000-18
18 mm



20-1000-20
20 mm



Cuzzi
30 cm / 11 3/4"



Pestalozza
20-1010-30
30 cm / 11 3/4"



21

Urology

Urologie

Urología

Urologia



21-0010-15
15 cm / 6"



21-0010-17
17 cm / 6¾"



21-0010-20
20 cm / 8"



21-0010-25
25 cm / 9¾"

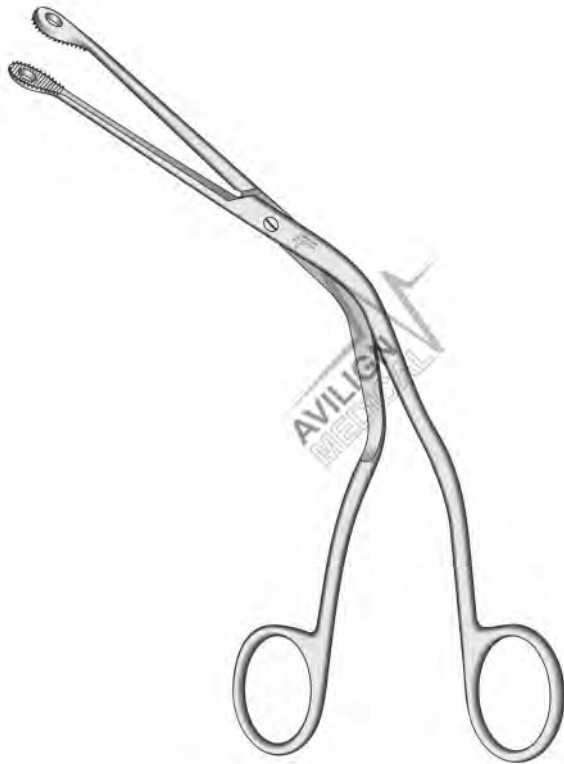

Magill



Guyon
21-0020-39
39 cm / 15½"

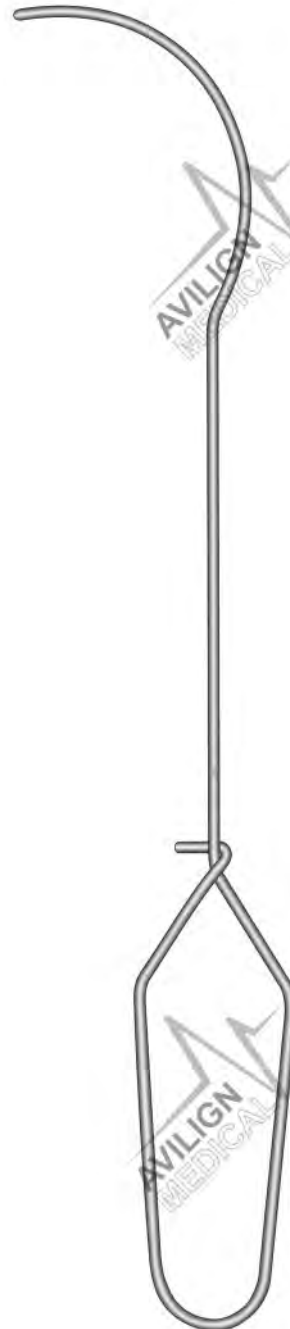

Guyon
21-0030-35
35 cm / 13¾"

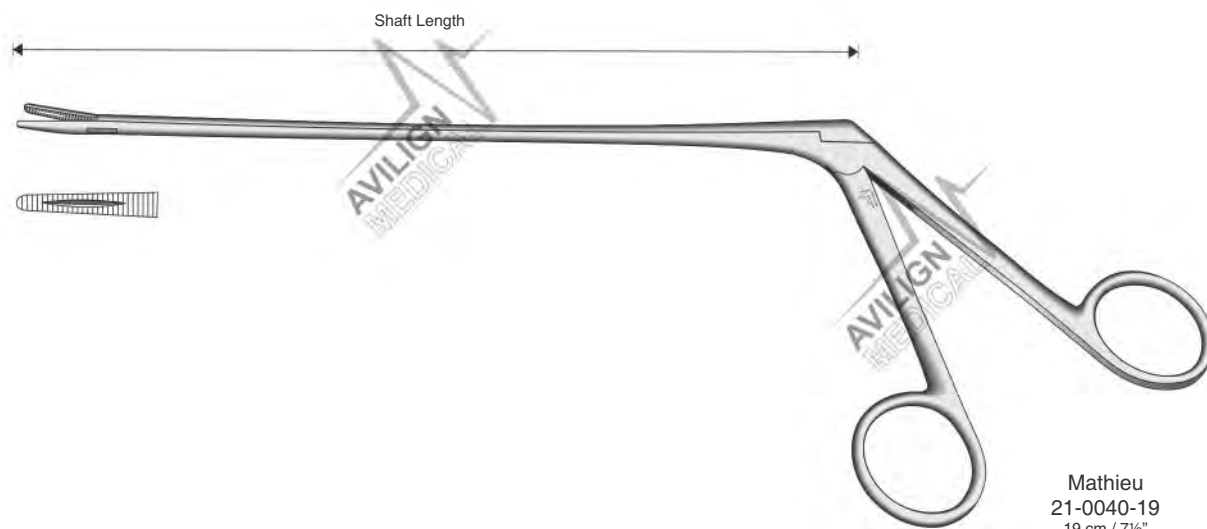

Mathieu
21-0040-19
19 cm / 7½"

21-0040-28
28 cm / 11"
Foreign Body Forceps

Dilatationsbougies, Metallkatheter
 Bujías Dilatadoras, Sondas Metálicas
 Candelette Dilatatrici, Cateteri Metallici
 Dilating Bougies, Metal Catheters



Guyon
 21-0050-00
 Complete Set with
 - 21 Bougies, Charr. 10 to 30,
 - 4 Filiform Bougies
 - In Metal Case of 42 x 17.5 x 4 cm

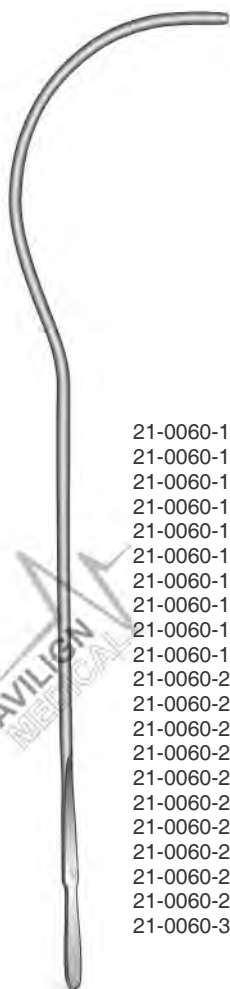

Guyon
 26 cm / 10¼"
 With Threat

- 21-0060-10 10 Charr.
- 21-0060-11 11 Charr.
- 21-0060-12 12 Charr.
- 21-0060-13 13 Charr.
- 21-0060-14 14 Charr.
- 21-0060-15 15 Charr.
- 21-0060-16 16 Charr.
- 21-0060-17 17 Charr.
- 21-0060-18 18 Charr.
- 21-0060-19 19 Charr.
- 21-0060-20 20 Charr.
- 21-0060-21 21 Charr.
- 21-0060-22 22 Charr.
- 21-0060-23 23 Charr.
- 21-0060-24 24 Charr.
- 21-0060-25 25 Charr.
- 21-0060-26 26 Charr.
- 21-0060-27 27 Charr.
- 21-0060-28 28 Charr.
- 21-0060-29 29 Charr.
- 21-0060-30 30 Charr.



15 cm / 6"
 For Women

- 21-0070-06 6 Charr.
- 21-0070-07 7 Charr.
- 21-0070-08 8 Charr.
- 21-0070-09 9 Charr.
- 21-0070-10 10 Charr.
- 21-0070-11 11 Charr.
- 21-0070-12 12 Charr.
- 21-0070-13 13 Charr.
- 21-0070-14 14 Charr.
- 21-0070-16 16 Charr.
- 21-0070-18 18 Charr.
- 21-0070-20 20 Charr.
- 21-0070-22 22 Charr.
- 21-0070-24 24 Charr.



25 cm / 10"
 For Men

- 21-0080-08 8 Charr.
- 21-0080-10 10 Charr.
- 21-0080-12 12 Charr.
- 21-0080-14 14 Charr.
- 21-0080-16 16 Charr.
- 21-0080-18 18 Charr.
- 21-0080-20 20 Charr.

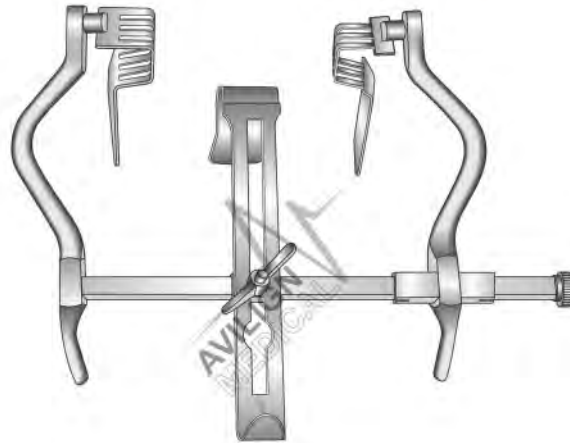

Judd-Masson
21-0090-00
Set
Lateral Blades 25 x 70 mm Central Blade 24 x 84 mm

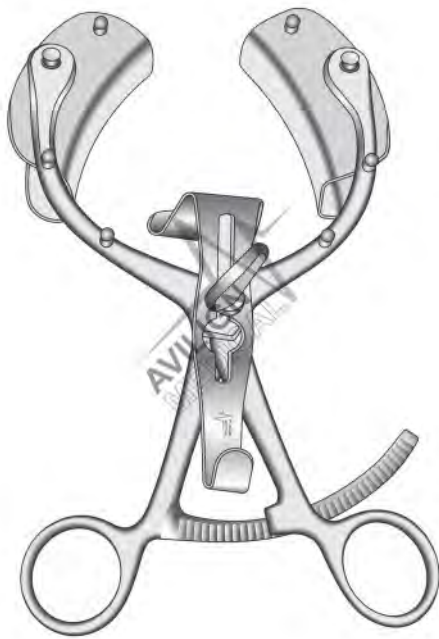

Legueu

21-0100-00
Set

21-0100-01
Bladder Retractor, Only

21-0100-10 30 x 85 mm
Central Blade, Only

21-0100-11 30 x 63 mm
Lateral Blades Pair, Only

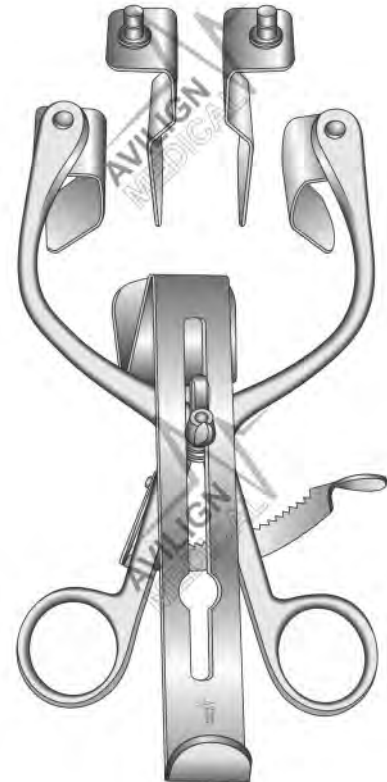

21-0110-00
Set

21-0110-01
Bladder Retractor, Only

21-0110-02 110 x 45 mm
Central Blade, Only

21-0110-03 57 x 25 mm
21-0110-04 80 x 25 mm
Lateral Blades Pair, Only

Millin



22

Bone Surgery

Knochenchirurgie

Cirurgía ósea

Chirurgia ossea

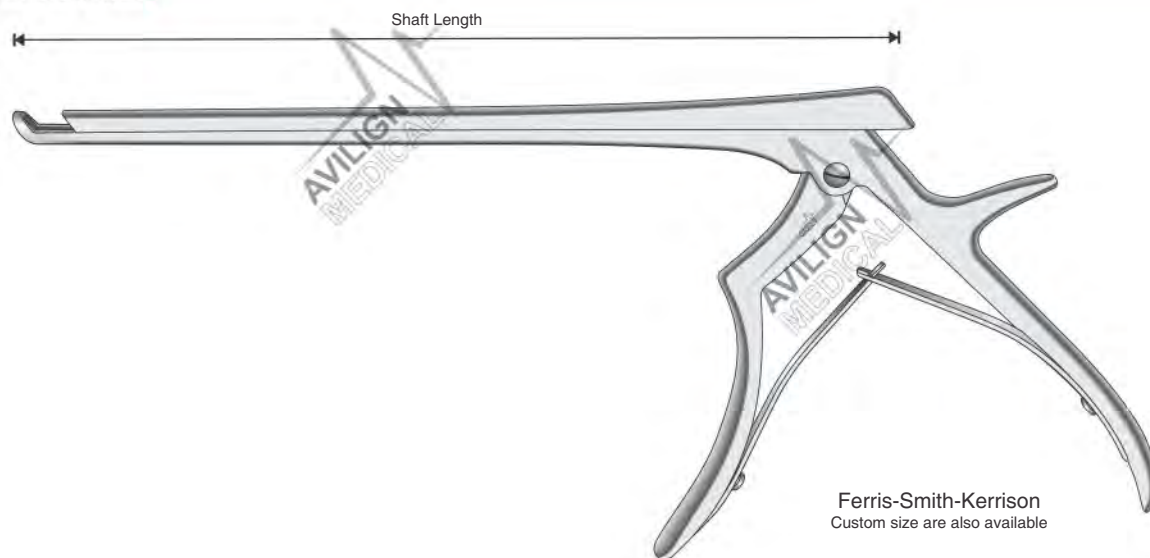

Width of Bite	Shaft Length	40° Upwards	90° Upwards	40° Downwards	90° Downwards
1 mm	18 cm / 7"	22-0010-01	22-0020-01	22-0030-01	22-0040-01
2 mm	18 cm / 7"	22-0010-02	22-0020-02	22-0030-02	22-0040-02
3 mm	18 cm / 7"	22-0010-03	22-0020-03	22-0030-03	22-0040-03
4 mm	18 cm / 7"	22-0010-04	22-0020-04	22-0030-04	22-0040-04
5 mm	18 cm / 7"	22-0010-05	22-0020-05	22-0030-05	22-0040-05
6 mm	18 cm / 7"	22-0010-06	22-0020-06	22-0030-06	22-0040-06
1 mm	20 cm / 8"	22-0050-01	22-0060-01	22-0070-01	22-0080-01
2 mm	20 cm / 8"	22-0050-02	22-0060-02	22-0070-02	22-0080-02
3 mm	20 cm / 8"	22-0050-03	22-0060-03	22-0070-03	22-0080-03
4 mm	20 cm / 8"	22-0050-04	22-0060-04	22-0070-04	22-0080-04
5 mm	20 cm / 8"	22-0050-05	22-0060-05	22-0070-05	22-0080-05
6 mm	20 cm / 8"	22-0050-06	22-0060-06	22-0070-06	22-0080-06
1 mm	23 cm / 9"	22-0090-01	22-0100-01	22-0110-01	22-0120-01
2 mm	23 cm / 9"	22-0090-02	22-0100-02	22-0110-02	22-0120-02
3 mm	23 cm / 9"	22-0090-03	22-0100-03	22-0110-03	22-0120-03
4 mm	23 cm / 9"	22-0090-04	22-0100-04	22-0110-04	22-0120-04
5 mm	23 cm / 9"	22-0090-05	22-0100-05	22-0110-05	22-0120-05
6 mm	23 cm / 9"	22-0090-06	22-0100-06	22-0110-06	22-0120-06



Laminektomie-stanzen
 Pinzas Cortantes Para Laminectomía
 Pinze Per Laminectomia
 Laminectomy Punches

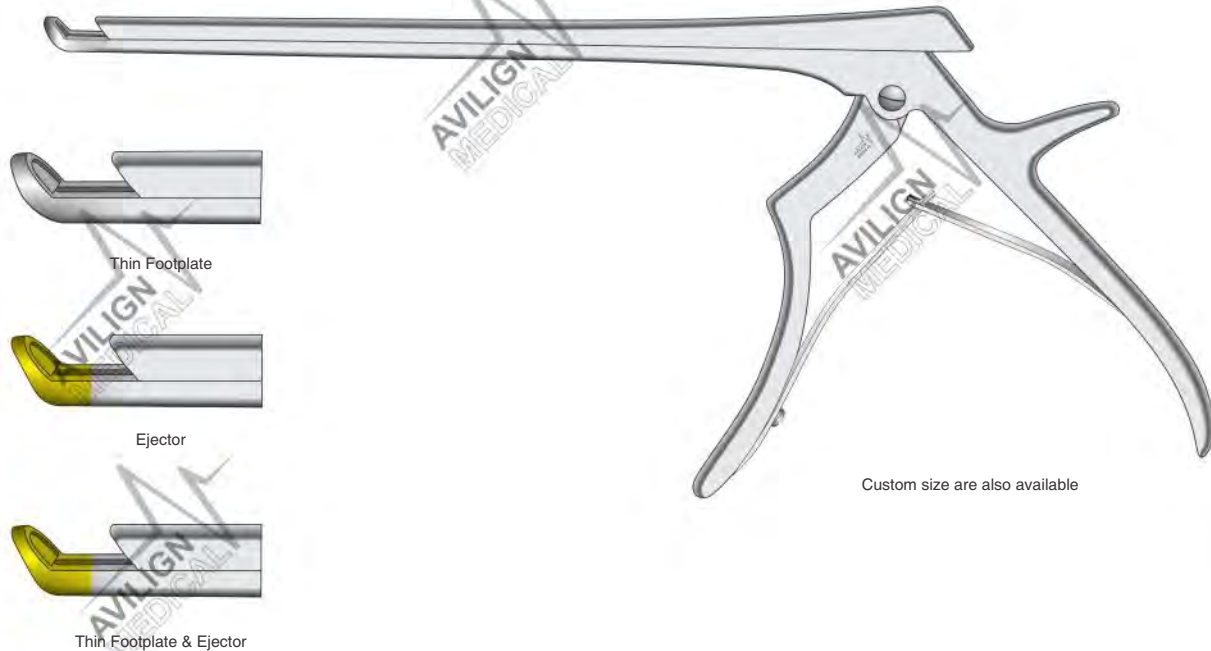

Custom size are also available



Bite	Shaft Length	Thin Footplate 40° Upwards	Ejector 40° Upwards	Thin Footplate & Ejector 40° Upwards	40° Downwards	90° Upwards	90° Downwards
1 mm	18 cm / 7"	22-0130-01	22-0135-01	22-0140-01	22-0145-01	22-0150-01	22-0155-01
2 mm	18 cm / 7"	22-0130-02	22-0135-02	22-0140-02	22-0145-02	22-0150-02	22-0155-02
3 mm	18 cm / 7"	22-0130-03	22-0135-03	22-0140-03	22-0145-03	22-0150-03	22-0155-03
4 mm	18 cm / 7"	22-0130-04	22-0135-04	22-0140-04	22-0145-04	22-0150-04	22-0155-04
5 mm	18 cm / 7"	22-0130-05	22-0135-05	22-0140-05	22-0145-05	22-0150-05	22-0155-05
6 mm	18 cm / 7"	22-0130-06	22-0135-06	22-0140-06	22-0145-06	22-0150-06	22-0155-06
1 mm	20 cm / 8"	22-0160-01	22-0165-01	22-0170-01	22-0175-01	22-0180-01	22-0185-01
2 mm	20 cm / 8"	22-0160-02	22-0165-02	22-0170-02	22-0175-02	22-0180-02	22-0185-02
3 mm	20 cm / 8"	22-0160-03	22-0165-03	22-0170-03	22-0175-03	22-0180-03	22-0185-03
4 mm	20 cm / 8"	22-0160-04	22-0165-04	22-0170-04	22-0175-04	22-0180-04	22-0185-04
5 mm	20 cm / 8"	22-0160-05	22-0165-05	22-0170-05	22-0175-05	22-0180-05	22-0185-05
6 mm	20 cm / 8"	22-0160-06	22-0165-06	22-0170-06	22-0175-06	22-0180-06	22-0185-06
1 mm	23 cm / 9"	22-0190-01	22-0195-01	22-0200-01	22-0205-01	22-0210-01	22-0215-01
2 mm	23 cm / 9"	22-0190-02	22-0195-02	22-0200-02	22-0205-02	22-0210-02	22-0215-02
3 mm	23 cm / 9"	22-0190-03	22-0195-03	22-0200-03	22-0205-03	22-0210-03	22-0215-03
4 mm	23 cm / 9"	22-0190-04	22-0195-04	22-0200-04	22-0205-04	22-0210-04	22-0215-04
5 mm	23 cm / 9"	22-0190-05	22-0195-05	22-0200-05	22-0205-05	22-0210-05	22-0215-05
6 mm	23 cm / 9"	22-0190-06	22-0195-06	22-0200-06	22-0205-06	22-0210-06	22-0215-06

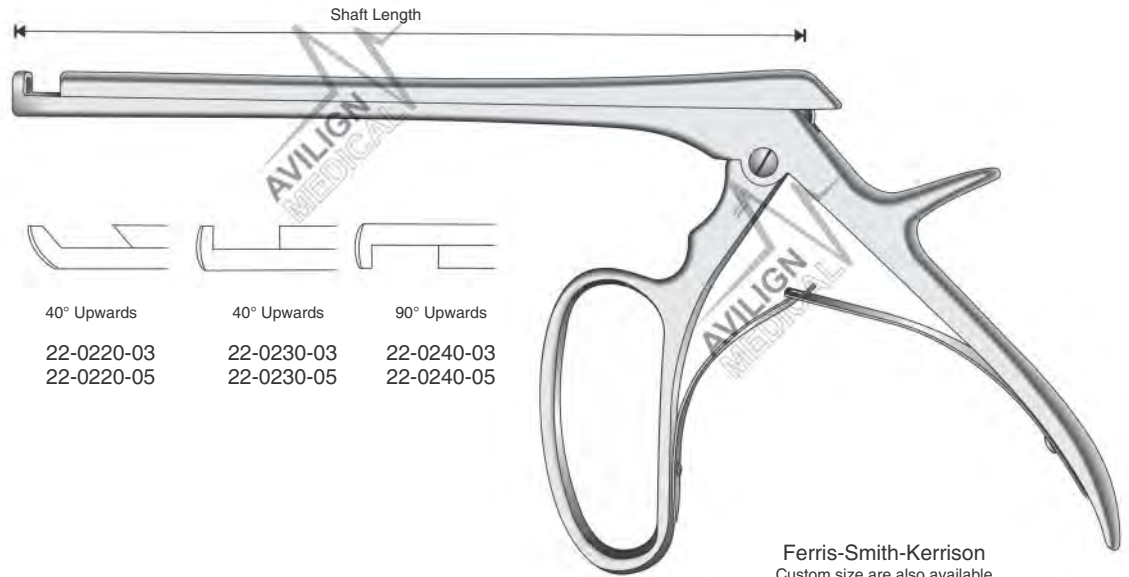

Ferris-Smith-Kerrison
Custom size are also available

Width of Bite	Shaft Length	40° Upwards	40° Upwards	90° Upwards
3 mm	18 cm / 7"	22-0220-03	22-0230-03	22-0240-03
5 mm	18 cm / 7"	22-0220-05	22-0230-05	22-0240-05

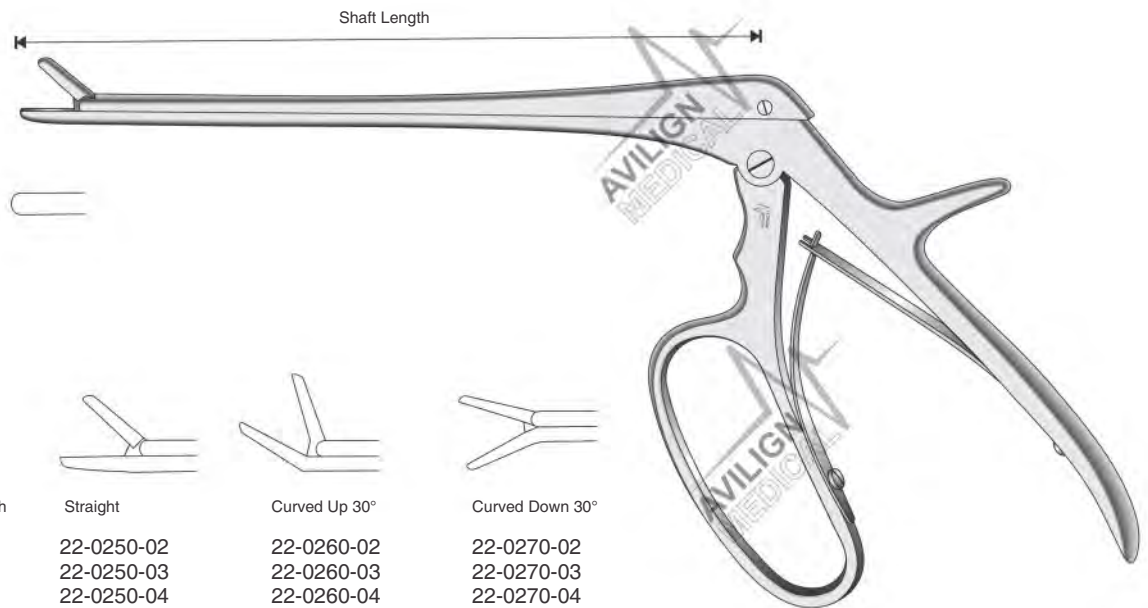

Ferris-Smith-Kerrison
Custom size are also available

Width of Bite	Shaft Length	Straight	Curved Up 30°	Curved Down 30°
2 x 10 mm	18 cm / 7"	22-0250-02	22-0260-02	22-0270-02
3 x 10 mm	18 cm / 7"	22-0250-03	22-0260-03	22-0270-03
4 x 10 mm	18 cm / 7"	22-0250-04	22-0260-04	22-0270-04
5 x 10 mm	18 cm / 7"	22-0250-05	22-0260-05	22-0270-05
6 x 10 mm	18 cm / 7"	22-0250-06	22-0260-06	22-0270-06

Laminektomie-zangen
Pinzas Cortantes Para Laminectomía
Pinze Per Laminectomia
Laminectomy Rongeurs

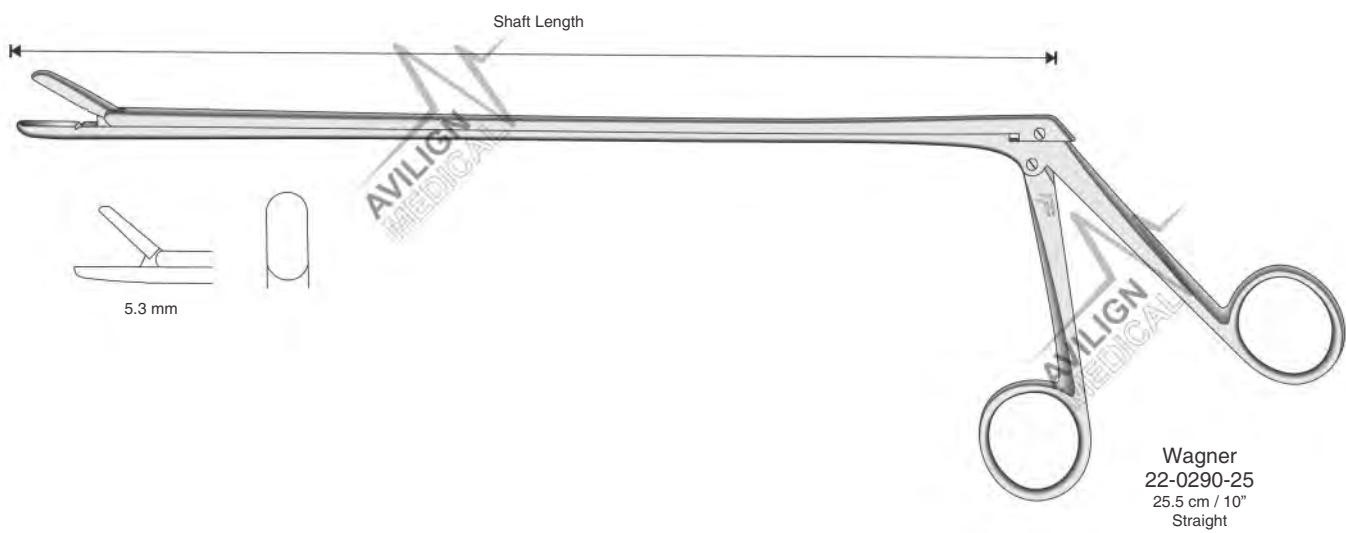
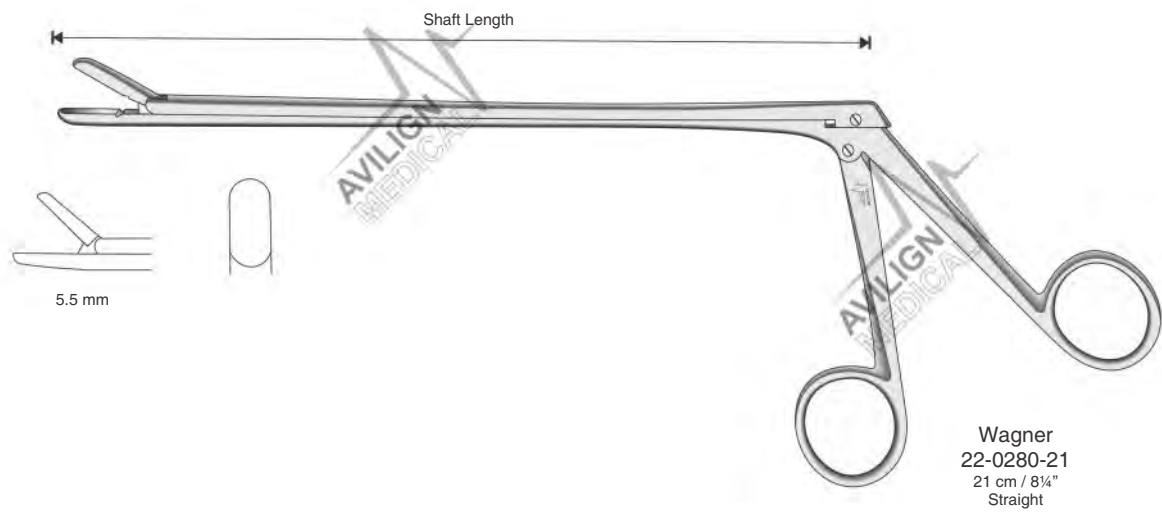

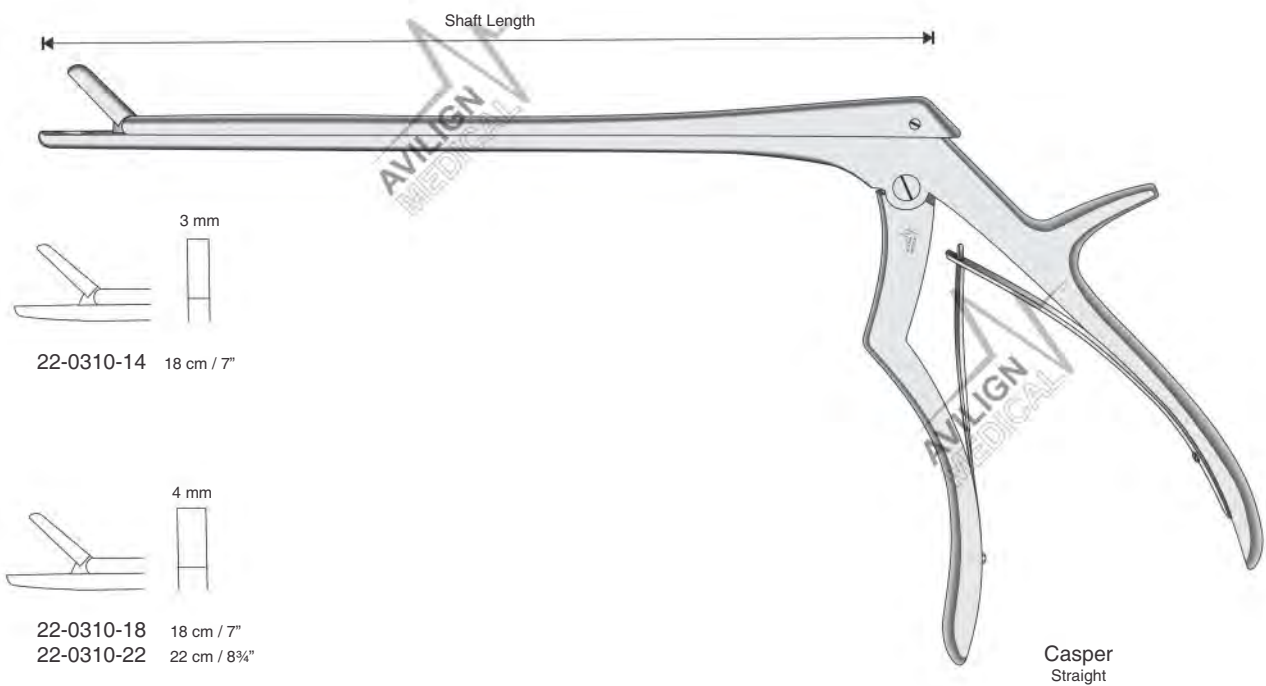
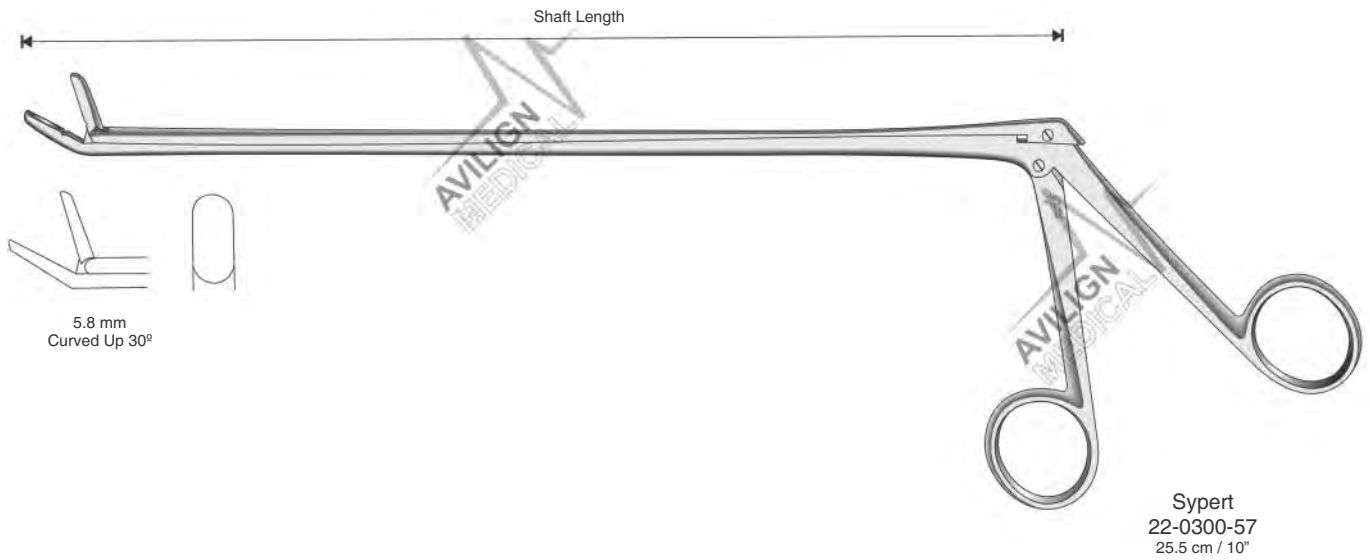

Nasenzangen
 Pinzas Nasales
 Pinze Nasali
 Nasal Forceps

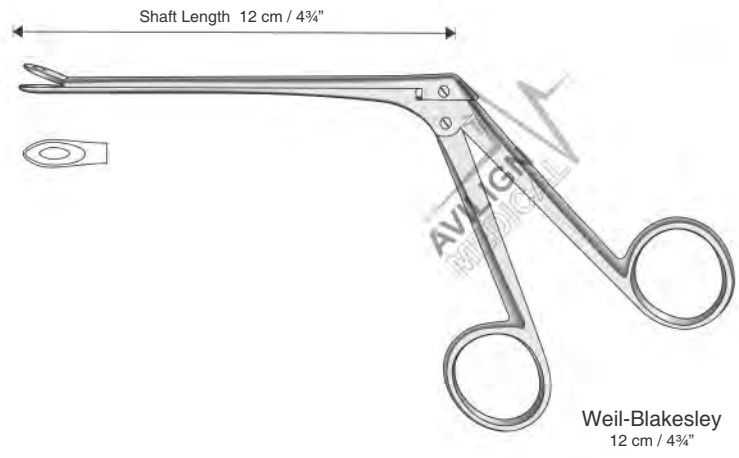

Weil-Blakesley
 12 cm / 4 3/4"

Width of Bite

- 3 mm
- 3.6 mm
- 4.2 mm
- 4.8 mm
- 5.2 mm

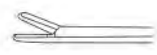

Straight

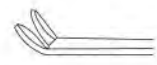

Curved Up 45°



Curved Up 90°

- 22-0320-30
- 22-0320-36
- 22-0320-42
- 22-0320-48
- 22-0320-52

- 22-0330-30
- 22-0330-36
- 22-0330-42
- 22-0330-48
- 22-0330-52

- 22-0340-30
- 22-0340-36
- 22-0340-42
- 22-0340-48
- 22-0340-52

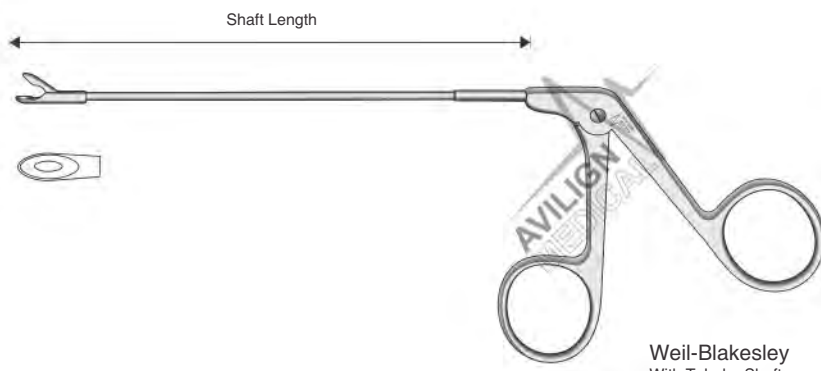

Weil-Blakesley
 With Tubular Shaft

Width of Bite

- 3.0 mm
- 3.6 mm
- 4.2 mm
- 4.8 mm

Length Of Shaft

- 13 cm / 5"
- 13 cm / 5"
- 13 cm / 5"
- 13 cm / 5"

Straight

- 22-0350-30
- 22-0350-36
- 22-0350-42
- 22-0350-48

Curved Up 45°

- 22-0360-30
- 22-0360-36
- 22-0360-42
- 22-0360-48

Curved Up 90°

- 22-0370-30
- 22-0370-36
- 22-0370-42

- 3.0 mm
- 3.6 mm

- 17 cm / 6 3/4"
- 17 cm / 6 3/4"

- 22-0380-30
- 22-0380-36

- 22-0390-30
- 22-0390-36

- 22-0400-30
- 22-0400-36



- 22-0410-05 5 mm
- 22-0410-07 7 mm
- 22-0410-09 9 mm
- 22-0410-11 11 mm
- Straight, Through Cut

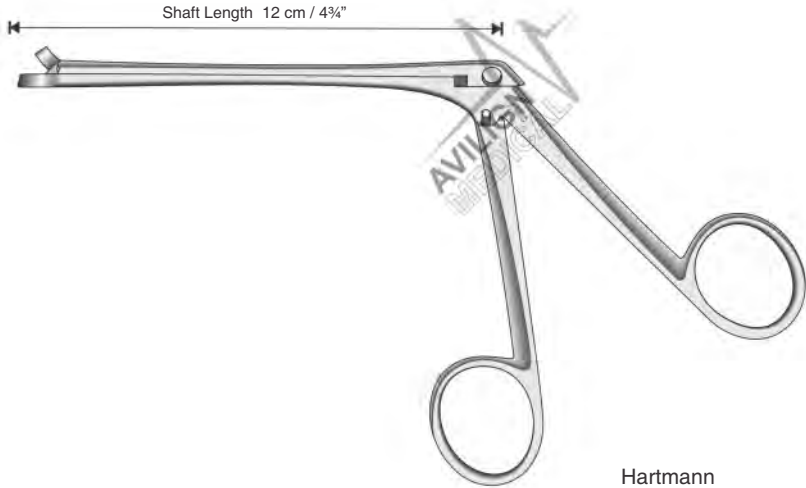

Hartmann
12 cm / 4 3/4"



- 22-0420-13 13 mm
- 22-0420-15 15 mm
- 22-0420-17 17 mm
- Straight, Through Cut

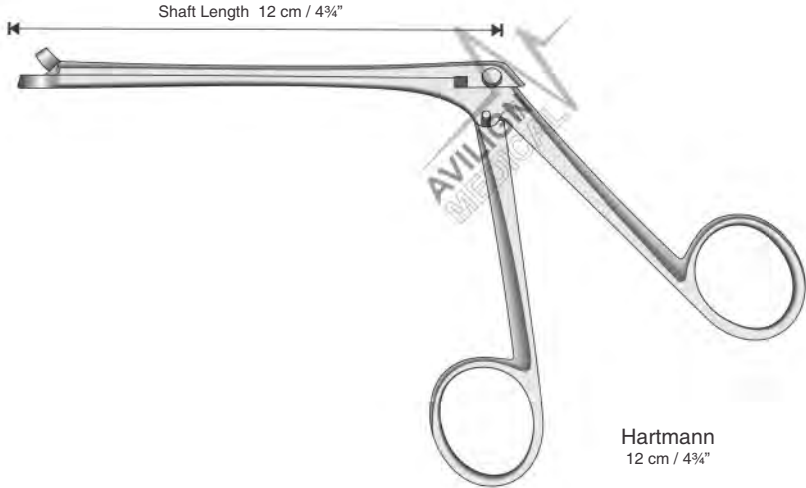

Hartmann
12 cm / 4 3/4"



- 22-0430-03 3 mm
- 22-0430-05 5 mm
- Straight



- 22-0440-03 3 mm
- 22-0440-05 5 mm
- Straight



- 22-0450-03 3 mm
- 22-0450-05 5 mm
- Curved Up 45°

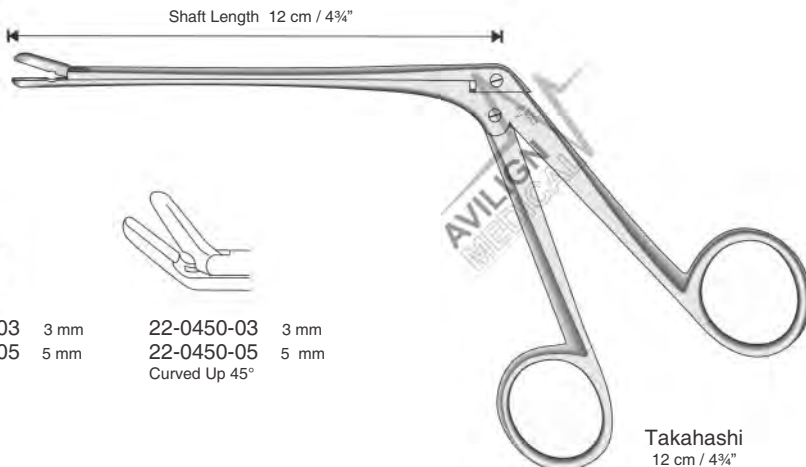

Takahashi
12 cm / 4 3/4"

Nasenzangen, Laminektomie-zangen
 Pinzas Nasales, Pinzas Cortantes Para Laminectomía
 Pinze Nasali, Pinze Per Laminectomia
 Nasal Forceps, Laminectomy Rongeurs

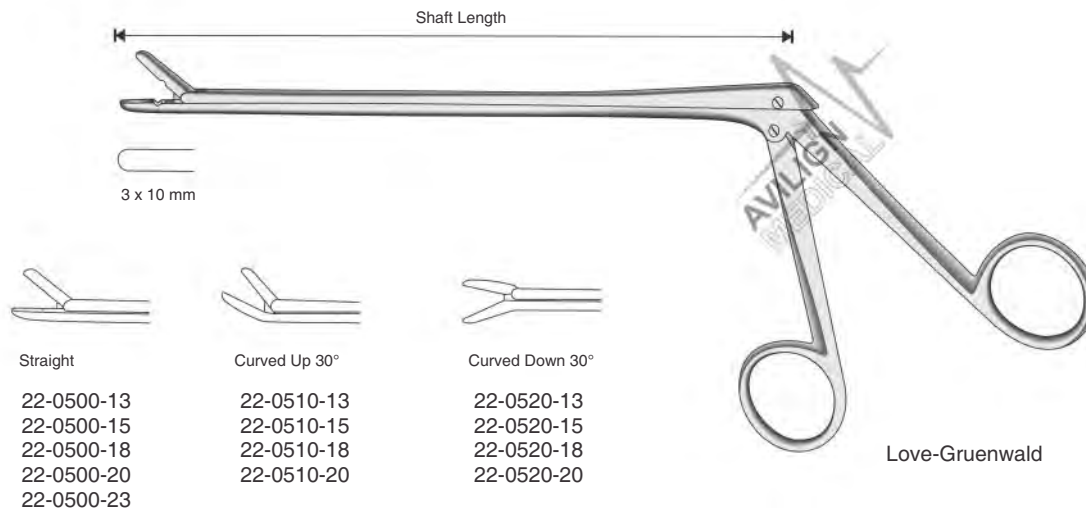
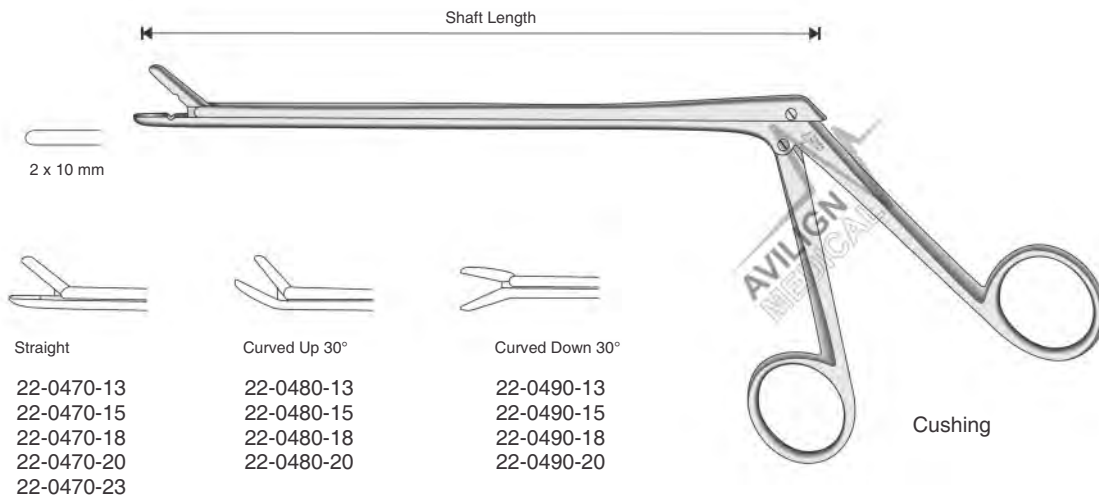
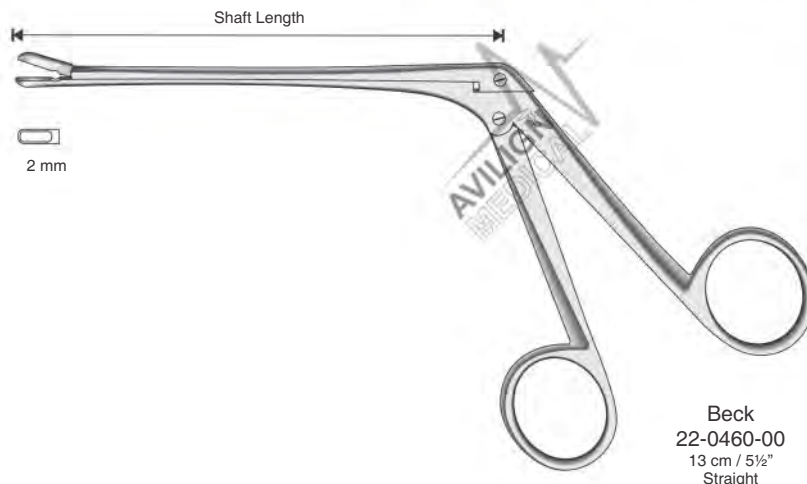

Shaft Length

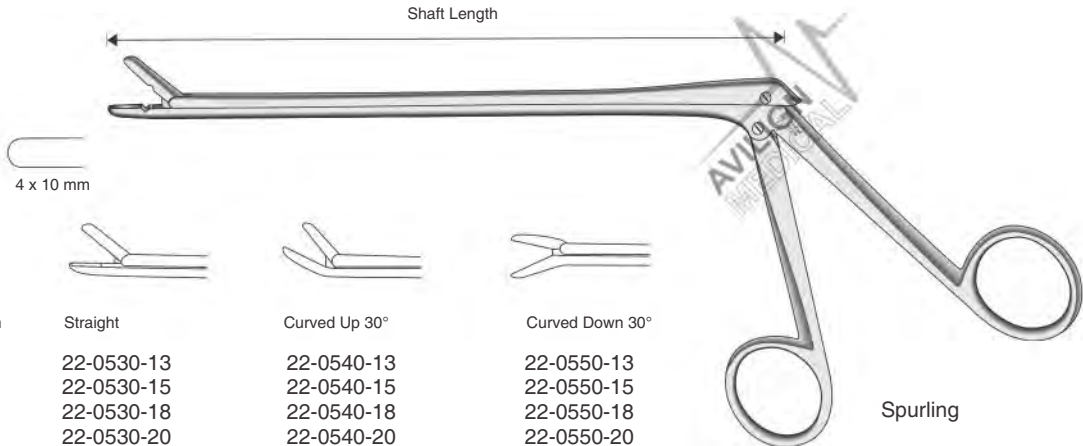

4 x 10 mm

Shaft Length	Straight	Curved Up 30°	Curved Down 30°
13 cm / 5"	22-0530-13	22-0540-13	22-0550-13
15 cm / 6"	22-0530-15	22-0540-15	22-0550-15
18 cm / 7"	22-0530-18	22-0540-18	22-0550-18
20 cm / 8"	22-0530-20	22-0540-20	22-0550-20
23 cm / 9"	22-0530-23		

Spurling

Shaft Length

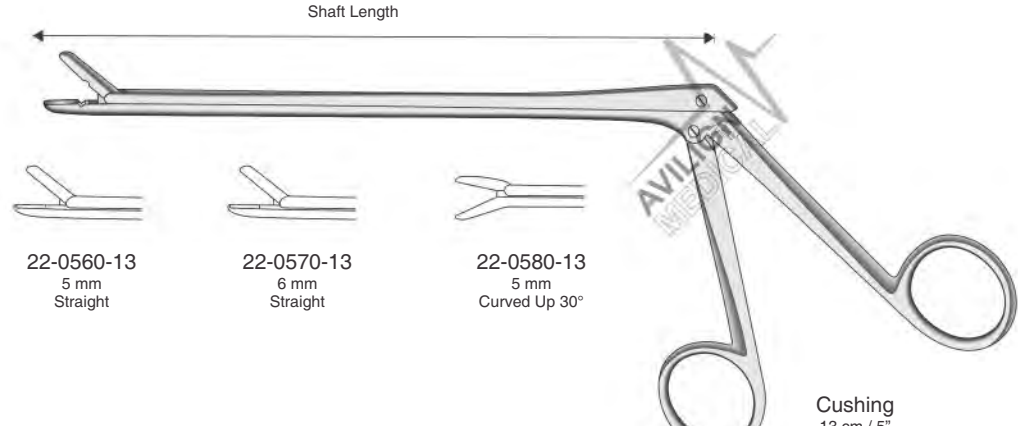

22-0560-13 5 mm Straight	22-0570-13 6 mm Straight	22-0580-13 5 mm Curved Up 30°
--------------------------------	--------------------------------	-------------------------------------

Cushing
13 cm / 5"

Shaft Length

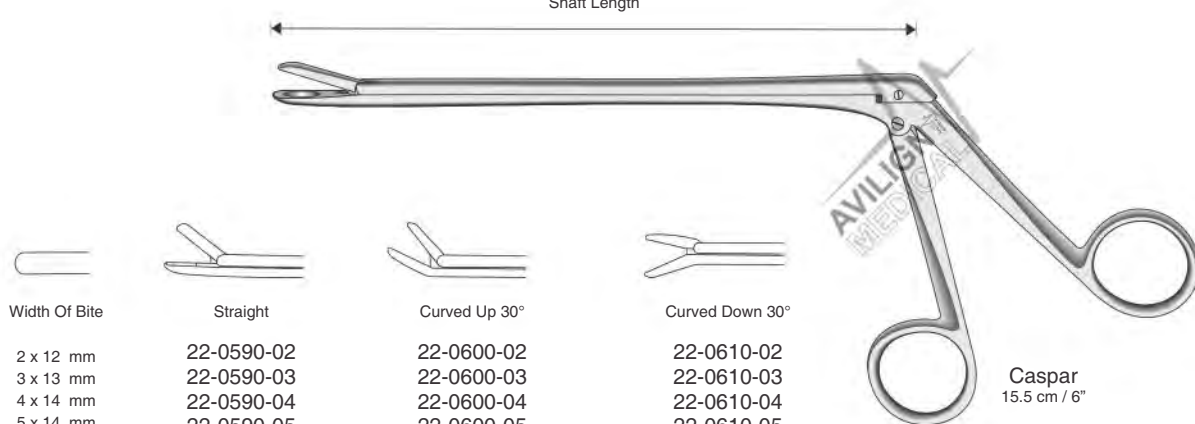

Width Of Bite	Straight	Curved Up 30°	Curved Down 30°
2 x 12 mm	22-0590-02	22-0600-02	22-0610-02
3 x 13 mm	22-0590-03	22-0600-03	22-0610-03
4 x 14 mm	22-0590-04	22-0600-04	22-0610-04
5 x 14 mm	22-0590-05	22-0600-05	22-0610-05

Caspar
15.5 cm / 6"

Laminektomie-zangen
 Pinzas Cortantes Para Laminectomía
 Pinze Per Laminectomia
 Laminectomy Rongeurs

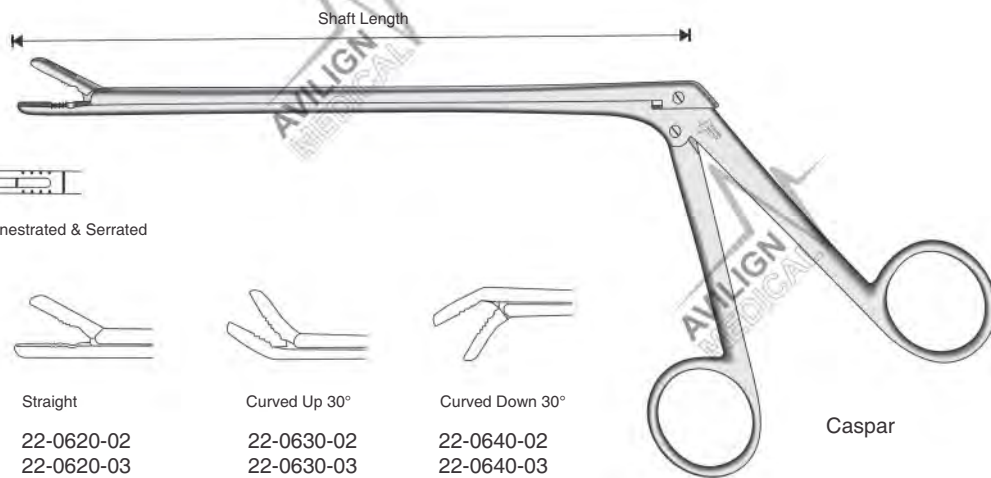

Width of Bite	Shaft Length	Straight	Curved Up 30°	Curved Down 30°
2 x 12 mm	14 cm / 5½"	22-0620-02	22-0630-02	22-0640-02
3 x 12 mm	14 cm / 5½"	22-0620-03	22-0630-03	22-0640-03
4 x 14 mm	14 cm / 5½"	22-0620-04	22-0630-04	22-0640-04
5 x 14 mm	14 cm / 5½"	22-0620-05	22-0630-05	22-0640-05
6 x 16 mm	14 cm / 5½"	22-0620-06		
2 x 12 mm	16 cm / 6¼"	22-0650-02	22-0660-02	22-0670-02
3 x 12 mm	16 cm / 6¼"	22-0650-03	22-0660-03	22-0670-03
4 x 14 mm	16 cm / 6¼"	22-0650-04	22-0660-04	22-0670-04
5 x 14 mm	16 cm / 6¼"	22-0650-05	22-0660-05	22-0670-05
6 x 16 mm	16 cm / 6¼"	22-0650-06		
2 x 12 mm	18.5 cm / 7¼"	22-0680-02	22-0690-02	22-0700-02
3 x 12 mm	18.5 cm / 7¼"	22-0680-03	22-0690-03	22-0700-03
4 x 14 mm	18.5 cm / 7¼"	22-0680-04	22-0690-04	22-0700-04
5 x 14 mm	18.5 cm / 7¼"	22-0680-05	22-0690-05	22-0700-05
6 x 16 mm	18.5 cm / 7¼"	22-0680-06		

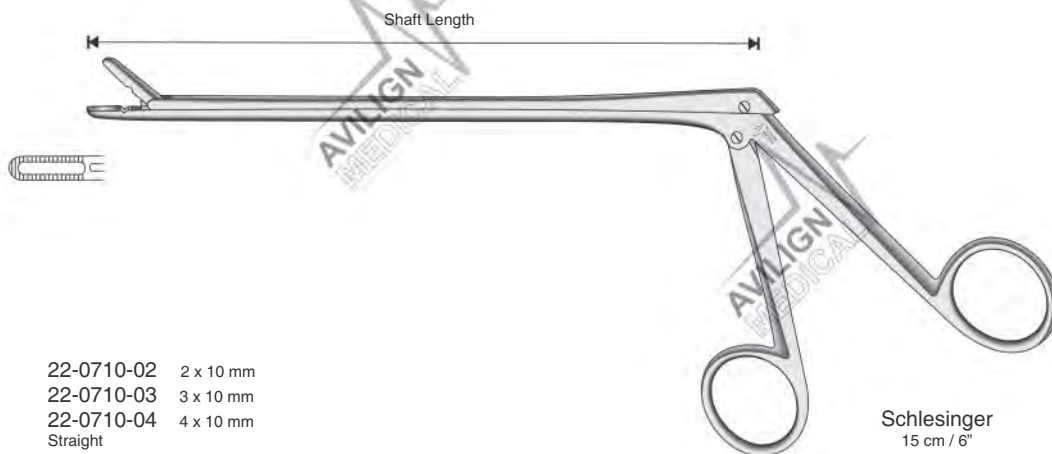

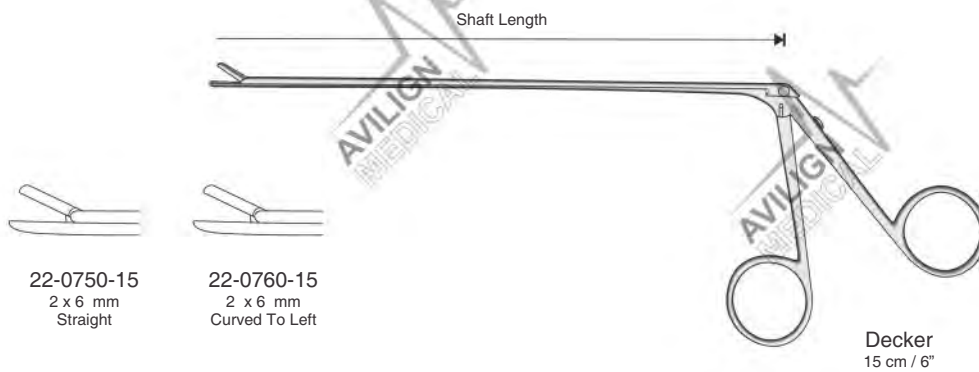
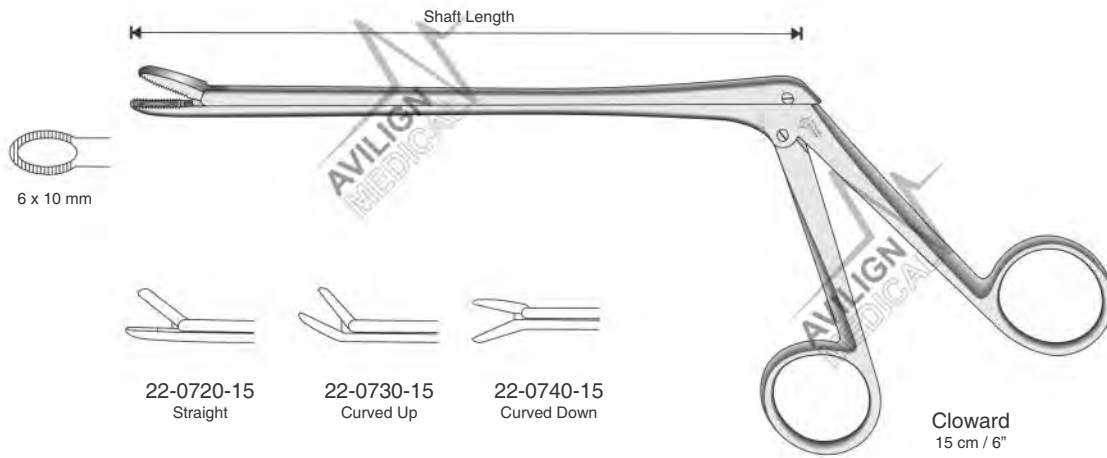



22-0770-03	3 mm
22-0770-04	4 mm
22-0770-05	5 mm
22-0770-06	6 mm

Kerrison
9 cm / 3½"
90° Cutting Upwards

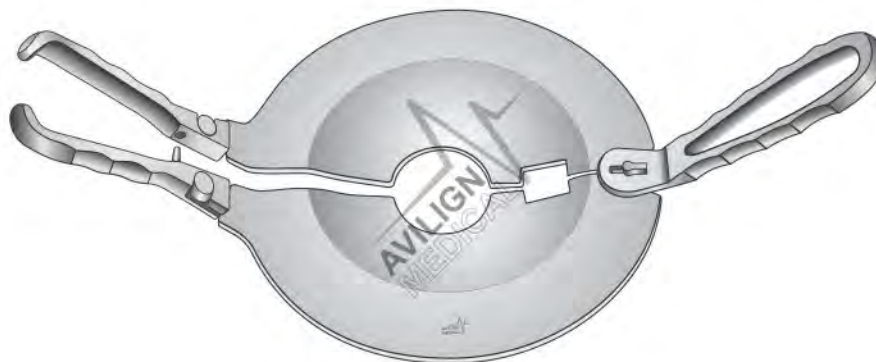

Percy
22-0780-01
Removable Handles

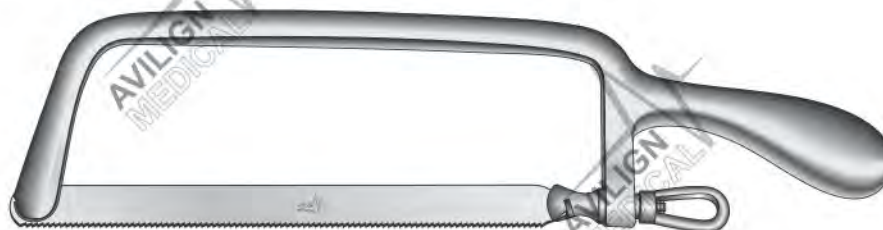

Charriere
22-0790-00
35 cm / 13 3/4"

With 2 Interchangeable Saw Blades
22-0800-12
22-0800-18

22-0800-12 12 x 215 mm
22-0800-15 15 x 215 mm
22-0800-18 18 x 215 mm
Spare Saw Blade



Helferich-Bier
22-0810-00
40.5 cm / 16"

With 3 Interchangeable Blades
22-0820-04
22-0820-06
22-0820-08

22-0820-04 4 x 270 mm
22-0820-06 6 x 270 mm
22-0820-08 8 x 270 mm
Spare Saw Blade



Charriere
 22-0830-00
 27 cm / 10¾"
 With one Interchangeable Blade
 22-0840-18

22-0840-18
 180 mm
 Spare Saw Blade



Satterlee
 22-0850-00
 29 cm / 11½"
 With one Interchangeable Blade
 22-0860-20

22-0860-20
 200 mm
 Spare Saw Blade



Langenbeck
 22-0870-00
 23.5 cm / 9¼"

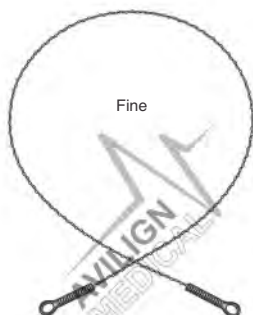

Gigli

22-0880-30	30 cm / 12"
22-0880-40	40 cm / 16"
22-0880-50	50 cm / 20"
22-0880-60	60 cm / 24"
22-0880-70	70 cm / 28"



Gigli
 22-0890-00
 7 cm / 2¼"
 T-Bar Handle For Wire Saws

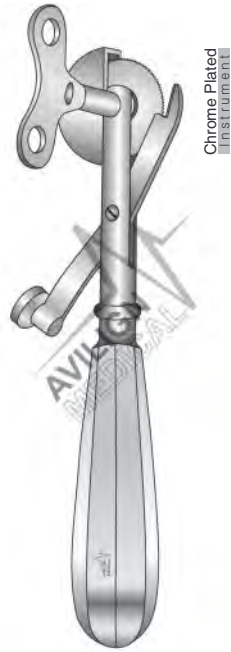

Chrome Plated
Instrument

Martin
22-0900-17
17 cm / 6¾"
22-0900-00
Spare Saw Blade



Chrome Plated
Instrument

Walton
22-0910-16
16 cm / 6¼"
22-0910-00
Spare Saw Blade



Adson
22-0920-14
14 cm / 5½"



22-0930-14 14 cm / 5½"
22-0930-16 16 cm / 6¼"



Perthes
22-0940-18
18 cm / 7"

Hämmer
Martillos
Martelli
Mallets



22-0950-22
Ø 20 mm
Head Weight 100 gm
Total Weight 140 gm

16.5 cm / 6½"
Lead Filled Head



22-0960-27
Ø 27 mm
Head Weight 160 gm
Total Weight 220 gm

Hajek
20 cm / 8"

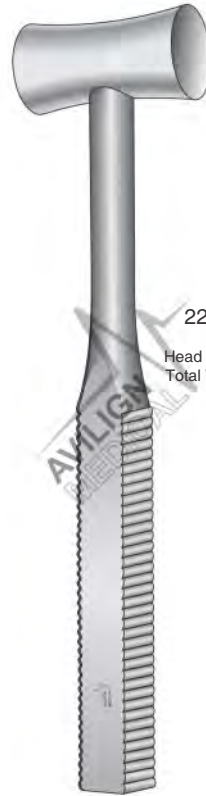

22-0970-30
Ø 30 mm
Head Weight 300 gm
Total Weight 480 gm

Bergmann
23.5 cm / 9¼"



22-0980-45
Ø 45 mm
Head Weight 380 gm
Total Weight 560 gm

Bergmann
25 cm / 10"



22-0990-26
Ø 26 mm
Head Weight 160 gm
Total Weight 320 gm

Williger
24 cm / 9½"
Lead Filled Head



22-1000-30
Ø 30 mm
Head Weight 220 gm
Total Weight 240 gm

Collin
20 cm / 8"



22-1010-19
Ø 19 mm
Head Weight 120 gm
Total Weight 200 gm

Lucae
19.5 cm / 7¾"

22-0990-28
Ø 28 mm
Head Weight 200 gm
Total Weight 360 gm

22-0990-30
Ø 30 mm
Head Weight 240 gm
Total Weight 380 gm

22-1010-25
Ø 25 mm
Head Weight 140 gm
Total Weight 240 gm

22-1010-30
Ø 30 mm
Head Weight 160 gm
Total Weight 260 gm
19.5 cm / 7¾"



22-1020-04
4 mm
Chisel

West
16 cm / 6¼"



22-1030-04
4 mm
Gouge

West
16 cm / 6¼"



22-1040-04
4 mm
Chisel

Freer
17 cm / 6¾"



22-1050-04
4 mm
Chisel

Freer
17 cm / 6¾"



22-1060-06
6 mm
Gouge

Freer
15 cm / 6"

Osteotome, Flachmeißel, Hohlmeißel
 Osteotomos, Cinceles, Gubias
 Osteotomos, Scalpelli, Sgorbie
 Osteotomes, Chisels, Gouges

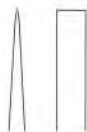

- 22-1070-04 4 mm
 - 22-1070-06 6 mm
 - 22-1070-08 8 mm
 - 22-1070-10 10 mm
 - 22-1070-12 12 mm
 - 22-1070-14 14 mm
 - 22-1070-16 16 mm
- Osteotomes



14 cm 5½"

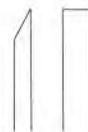

- 22-1080-04 4 mm
 - 22-1080-06 6 mm
 - 22-1080-08 8 mm
 - 22-1080-10 10 mm
 - 22-1080-12 12 mm
 - 22-1080-14 14 mm
 - 22-1080-16 16 mm
- Chisels



14 cm 5½"

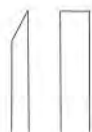

- 22-1090-02 2 mm
 - 22-1090-03 3 mm
 - 22-1090-04 4 mm
 - 22-1090-05 5 mm
 - 22-1090-06 6 mm
 - 22-1090-08 8 mm
 - 22-1090-10 10 mm
 - 22-1090-12 12 mm
- Chisels



Partsch
 14 cm / 5½"

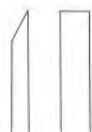

- 22-1100-02 2 mm
 - 22-1100-03 3 mm
 - 22-1100-04 4 mm
 - 22-1100-05 5 mm
 - 22-1100-06 6 mm
 - 22-1100-07 7 mm
 - 22-1100-08 8 mm
- Gouges



Partsch
 17 cm 6¾"

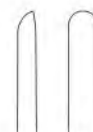

- 22-1110-02 2 mm
 - 22-1110-03 3 mm
 - 22-1110-04 4 mm
 - 22-1110-05 5 mm
 - 22-1110-06 6 mm
 - 22-1110-08 8 mm
 - 22-1110-10 10 mm
 - 22-1110-12 12 mm
- Gouges



Partsch
 14 cm 5½"

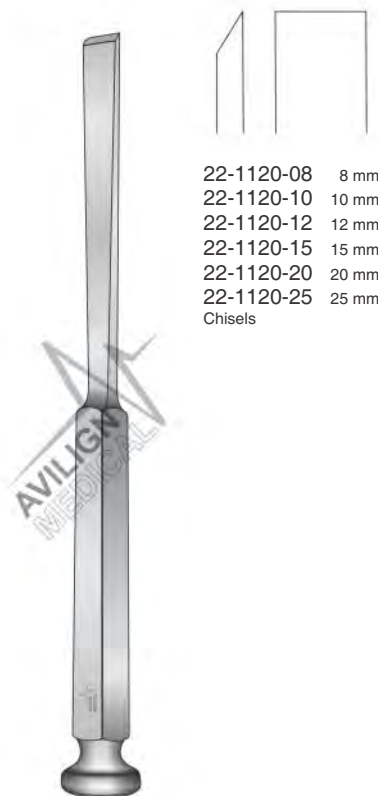

- 22-1120-08 8 mm
 - 22-1120-10 10 mm
 - 22-1120-12 12 mm
 - 22-1120-15 15 mm
 - 22-1120-20 20 mm
 - 22-1120-25 25 mm
- Chisels

Stille
20 cm / 8"

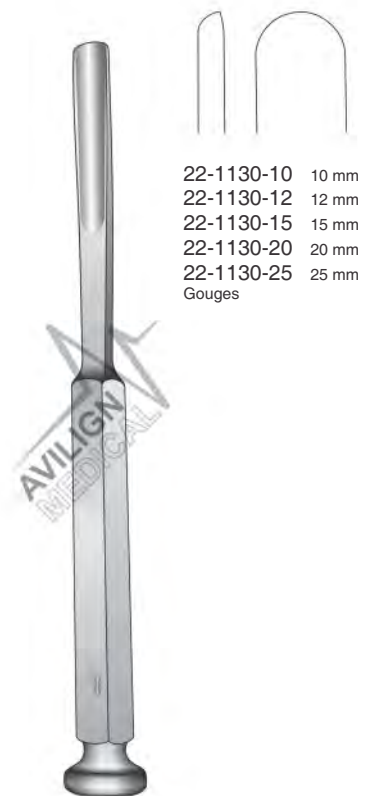

- 22-1130-10 10 mm
 - 22-1130-12 12 mm
 - 22-1130-15 15 mm
 - 22-1130-20 20 mm
 - 22-1130-25 25 mm
- Gouges

Stille
20 cm / 8"



- 22-1140-04 4 mm
 - 22-1140-06 6 mm
 - 22-1140-08 8 mm
 - 22-1140-10 10 mm
 - 22-1140-12 12 mm
 - 22-1140-14 14 mm
- Gouges

Alexander
17.5 cm / 7"

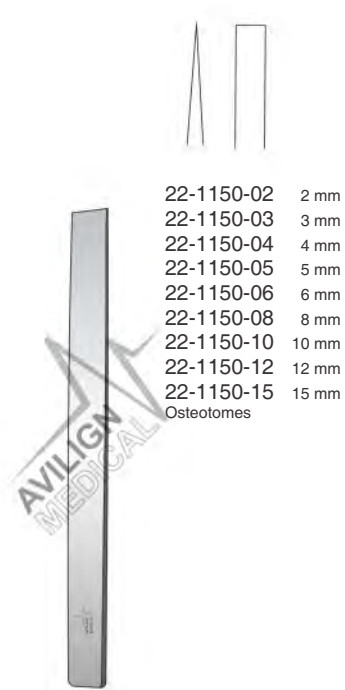

- 22-1150-02 2 mm
 - 22-1150-03 3 mm
 - 22-1150-04 4 mm
 - 22-1150-05 5 mm
 - 22-1150-06 6 mm
 - 22-1150-08 8 mm
 - 22-1150-10 10 mm
 - 22-1150-12 12 mm
 - 22-1150-15 15 mm
- Osteotomes

Mini-Lambotte
12.5 cm / 5"

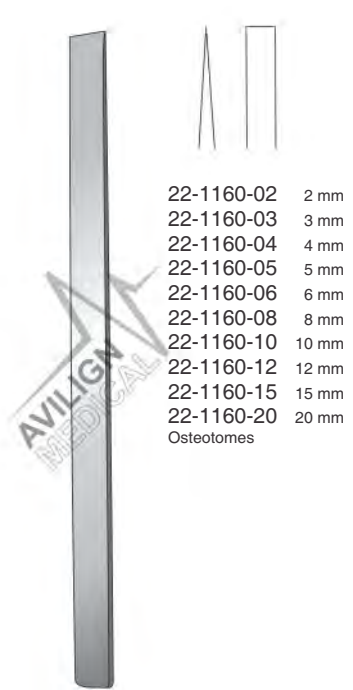

- 22-1160-02 2 mm
 - 22-1160-03 3 mm
 - 22-1160-04 4 mm
 - 22-1160-05 5 mm
 - 22-1160-06 6 mm
 - 22-1160-08 8 mm
 - 22-1160-10 10 mm
 - 22-1160-12 12 mm
 - 22-1160-15 15 mm
 - 22-1160-20 20 mm
- Osteotomes

Mini-Lambotte
17 cm / 6 3/4"

Osteotome, Flachmeißel
 Osteótomos, Cinceles
 Osteotomi, Scalpelli
 Osteotomes, Chisels

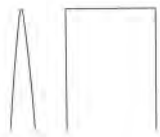

- 22-1170-04 4 mm
 - 22-1170-06 6 mm
 - 22-1170-08 8 mm
 - 22-1170-10 10 mm
 - 22-1170-13 13 mm
 - 22-1170-15 15 mm
 - 22-1170-18 18 mm
 - 22-1170-20 20 mm
 - 22-1170-25 25 mm
 - 22-1170-30 30 mm
 - 22-1170-38 38 mm
 - 22-1170-44 44 mm
 - 22-1170-50 50 mm
- Osteotomes



Lambotte
 24 cm / 9½"
 Straight

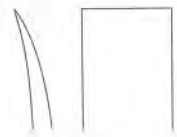

- 22-1180-04 4 mm
 - 22-1180-06 6 mm
 - 22-1180-08 8 mm
 - 22-1180-10 10 mm
 - 22-1180-13 13 mm
 - 22-1180-15 15 mm
 - 22-1180-18 18 mm
 - 22-1180-20 20 mm
 - 22-1180-25 25 mm
 - 22-1180-30 30 mm
 - 22-1180-38 38 mm
 - 22-1180-44 44 mm
 - 22-1180-50 50 mm
- Osteotomes



Lambotte
 24 cm / 9½"
 Curved

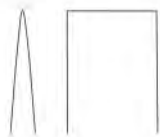

- 22-1190-06 6 mm
 - 22-1190-09 9 mm
 - 22-1190-13 13 mm
 - 22-1190-16 16 mm
 - 22-1190-19 19 mm
 - 22-1190-25 25 mm
 - 22-1190-32 32 mm
- Osteotomes



Hibbs
 24.5 cm / 9¾"

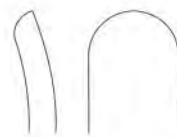

- 22-1200-06 6 mm
 - 22-1200-13 13 mm
 - 22-1200-19 19 mm
 - 22-1200-25 25 mm
 - 22-1200-32 32 mm
- Gouges



Hibbs
 24.5 cm / 9¾"

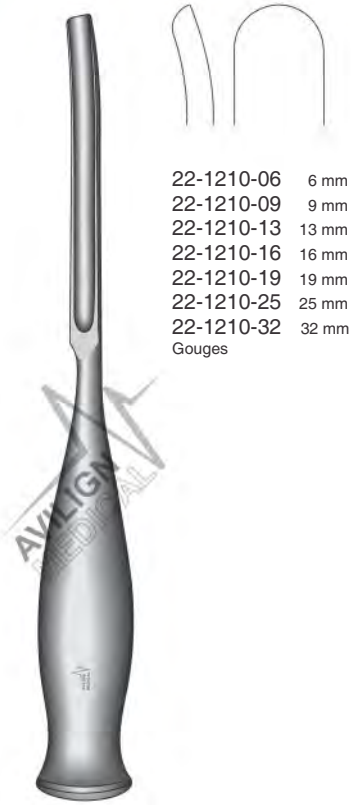

- 22-1210-06 6 mm
 - 22-1210-09 9 mm
 - 22-1210-13 13 mm
 - 22-1210-16 16 mm
 - 22-1210-19 19 mm
 - 22-1210-25 25 mm
 - 22-1210-32 32 mm
- Gouges

Smith-Petersen
20.5 cm / 8"
Curved



- 22-1220-06 6 mm
 - 22-1220-09 9 mm
 - 22-1220-13 13 mm
 - 22-1220-16 16 mm
 - 22-1220-19 19 mm
 - 22-1220-25 25 mm
 - 22-1220-32 32 mm
- Gouges

Smith-Petersen
20.5 cm / 8"
Straight

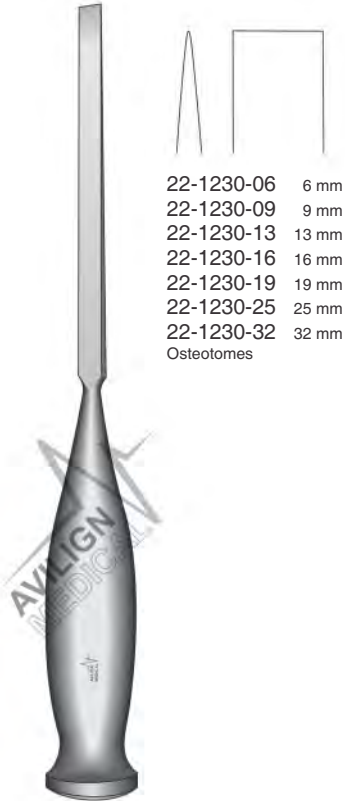

- 22-1230-06 6 mm
 - 22-1230-09 9 mm
 - 22-1230-13 13 mm
 - 22-1230-16 16 mm
 - 22-1230-19 19 mm
 - 22-1230-25 25 mm
 - 22-1230-32 32 mm
- Osteotomes

Smith-Petersen
20.5 cm / 8"



- 22-1240-04 4 mm
 - 22-1240-06 6 mm
 - 22-1240-08 8 mm
 - 22-1240-10 10 mm
 - 22-1240-12 12 mm
 - 22-1240-15 15 mm
- Gouges

Lexer-Mini
18.5 cm / 7¼"
Ferrozell Handle



- 22-1250-04 4 mm
 - 22-1250-06 6 mm
 - 22-1250-08 8 mm
 - 22-1250-10 10 mm
 - 22-1250-12 12 mm
- Gouges

Lexer-Mini
18.5 cm / 7¼"
Ferrozell Handle



Obwegeser
Elevators
6 mm



Obwegeser
Elevators
6 mm



Watson-Cheyne
Dissector

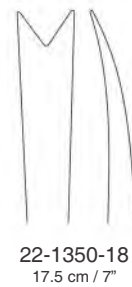

Obwegeser

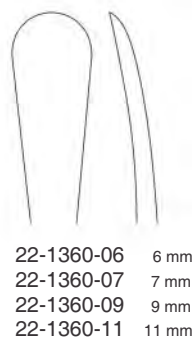

Obwegeser
17.5 cm / 7"

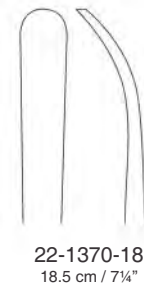

Tessier
Angled to 30°

Raspatorien, Elevatorien
 Periostótomos, Elevadores
 Periostotomi, Elevatori
 Raspatories, Elevators



22-1380-10
 10 mm
 Fig. 1



22-1380-13
 13 mm
 Fig. 2



22-1380-19
 19 mm
 Fig. 3



22-1380-25
 25 mm
 Fig. 4



Cobb
 28 cm / 11"

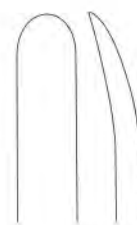

22-1390-06
 6 mm

22-1390-08
 8 mm



17 cm / 6¾"

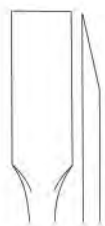

22-1400-01
 8 mm

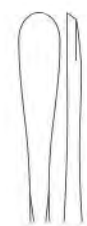

22-1400-02
 7 mm

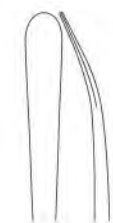

22-1400-03
 7 mm

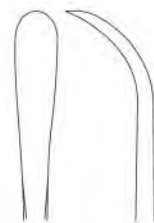

22-1400-04
 7 mm



Adson
 17 cm / 6¾"



22-1410-19
 19 cm / 7½"



Sewall

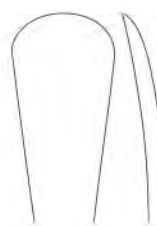

22-1420-14
 14 mm



Jansen
 19.5 cm / 7¾"



22-1430-15
12.5 mm

Farabeuf
15 cm / 6"
Straight



22-1440-15
12.5 mm

Farabeuf
15 cm / 6"
Curved

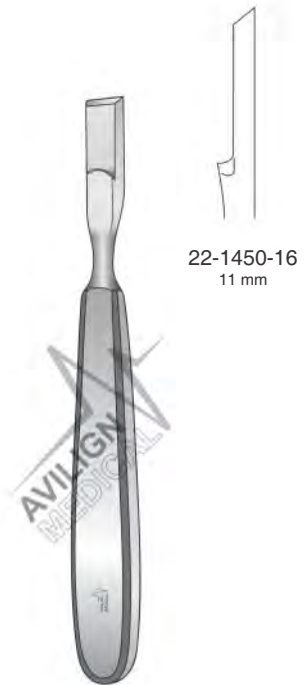

22-1450-16
11 mm

Farabeuf-Collin
16 cm / 6 3/4"
Straight

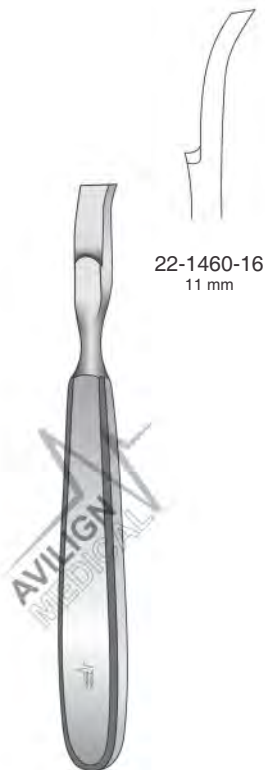

22-1460-16
11 mm

Farabeuf-Collin
16 cm / 6 3/4"
Curved

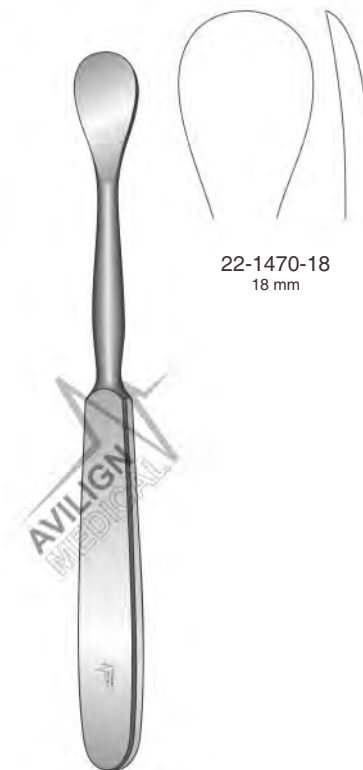

22-1470-18
18 mm

Sedillot
18.5 cm / 7 1/4"



22-1480-16
15 mm

Jansen
16.5 cm / 6 1/2"



22-1490-18
 14 mm



Langenbeck
 18 cm / 7"



22-1500-21
 14 mm



Sedillot
 21 cm / 8¼"

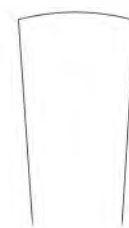

22-1510-05 5 mm
 22-1510-10 10 mm
 22-1510-15 15 mm
 22-1510-20 20 mm
 22-1510-25 25 mm



Lambotte
 21 cm / 8¼"



Mc Glamry
 17 cm / 6¾"

22-1520-09 9 mm
 22-1520-11 11 mm
 22-1520-13 13 mm
 22-1520-15 15 mm
 22-1520-17 17 mm

22-1530-06
 18 cm / 7"
 6 mm

22-1530-10
 19 cm / 7½"
 10 mm

22-1530-13
 19 cm / 7½"
 13 mm

22-1530-19
 20 cm / 8"
 19 mm

22-1530-25
 21 cm / 8¼"
 25 mm



Key

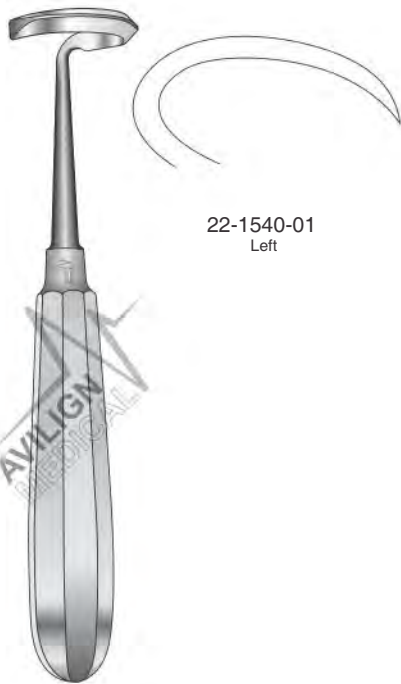

22-1540-01
Left

Doyen
17 cm / 6¾"
For Children

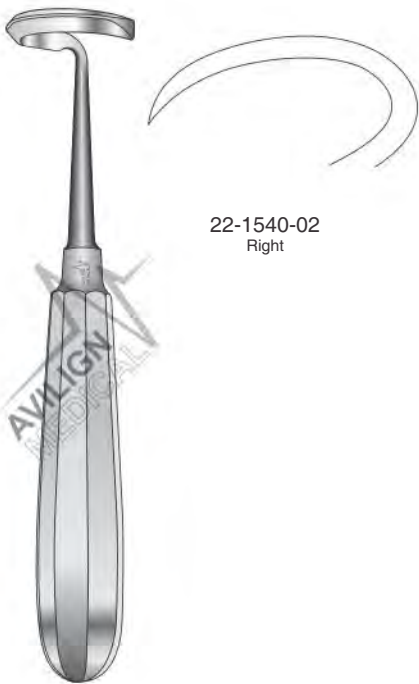

22-1540-02
Right

Doyen
17 cm / 6¾"
For Children

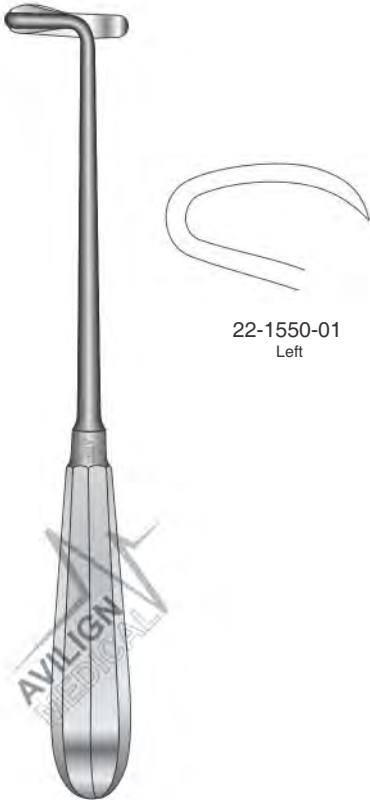

22-1550-01
Left

Doyen
17 cm / 6¾"
For Adults

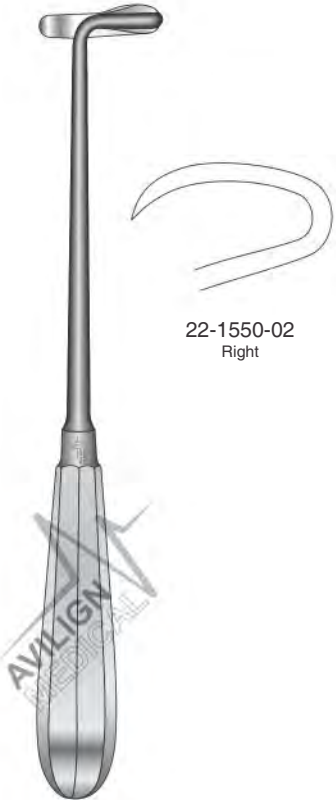

22-1550-02
Right

Doyen
17 cm / 6¾"
For Adults

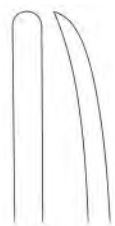

22-1560-01
 17 cm / 6¾"
 4 mm

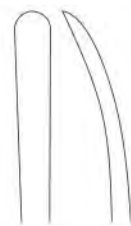

22-1560-02
 17 cm / 6¾"
 4 mm

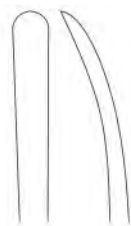

22-1560-03
 19.5 cm / 7¾"
 6 mm

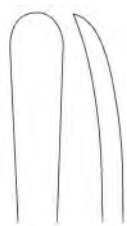

22-1560-04
 19.5 cm / 7¾"
 7 mm



Martin-Cushing

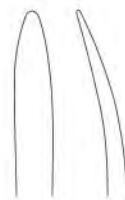

22-1570-01
 5.5 mm

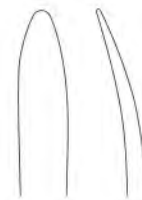

22-1570-02
 7 mm



Williger

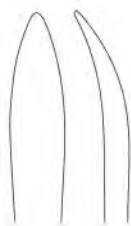

22-1580-08
 8 mm

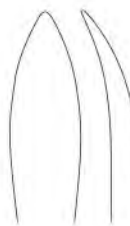

22-1580-10
 10 mm



Langenbeck
 19.5 cm / 7¾"

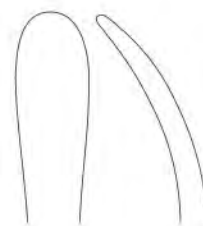

22-1590-11
 11 mm



Langenbeck
 23 cm / 9"



Mini-Hohmann
16 cm / 6¼"



Mini-Hohmann
16 cm / 6¼"

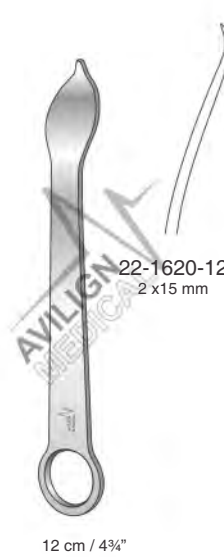

12 cm / 4¾"



22-1650-33
33 cm / 13"

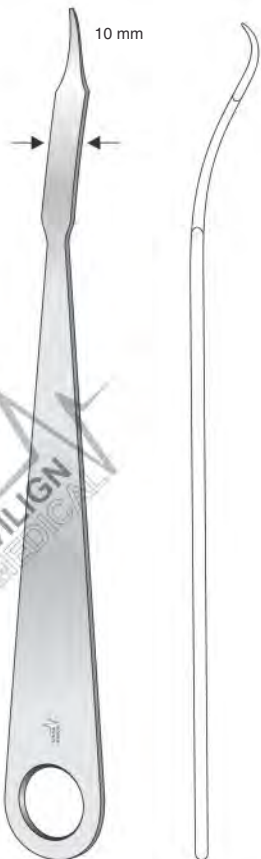

Hohmann
22-1630-22
22 cm / 8¾"

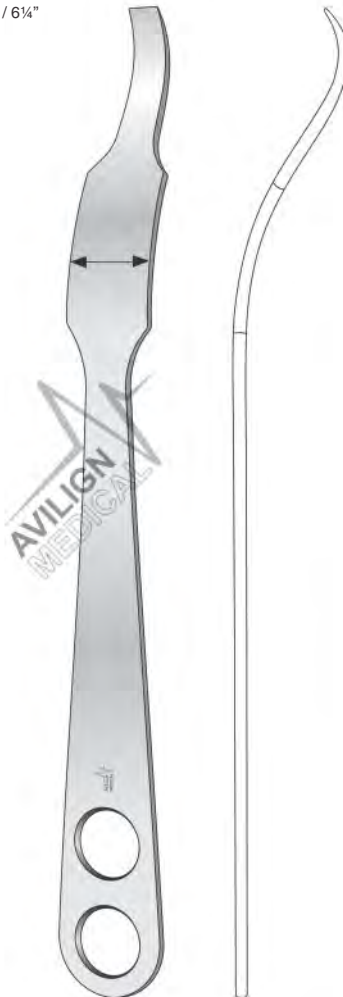

Hohmann
22-1640-26
26 cm / 10¼"



Wagner
Ferrozell Handle

Knochenhebel
Elevadores para huesos
Leve per ossa
Bone Levers

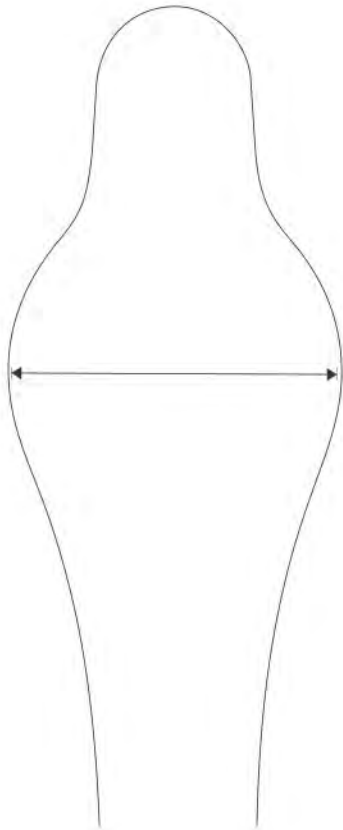

22-1660-23
25 / 43 mm

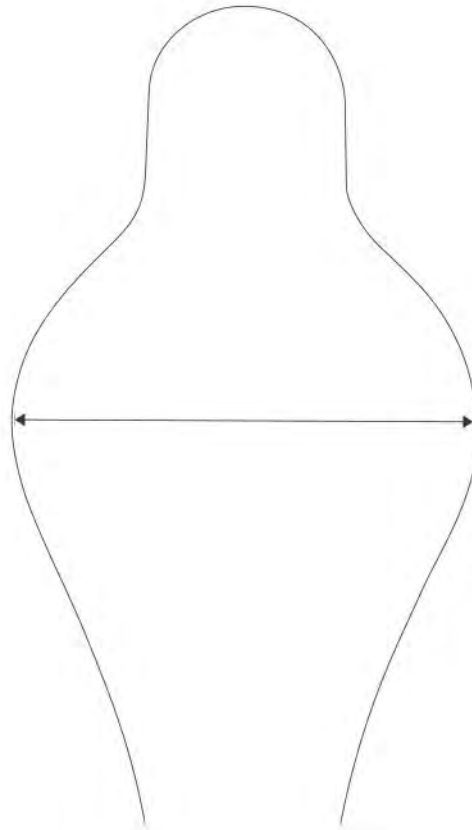

22-1660-24
25 / 63 mm



Bennet
24 cm / 9½"



22-1670-01
8 mm
Fine



22-1670-02
9 mm
Coarse



Joseph
16.5 cm / 6½"

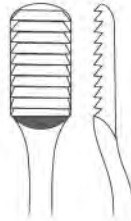

22-1680-01
15 x 8 mm
Fine

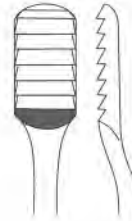

22-1680-02
15 x 8 mm
Coarse

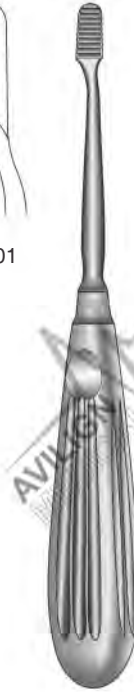

Lewis
18 cm / 7"



22-1690-22
22 cm / 8¾"

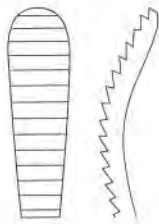

22-1700-01
32 x 9 mm
Upward
Serration

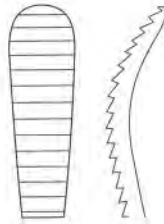

22-1700-02
32 x 9 mm
Downward
Serration

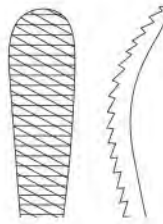

22-1700-03
32 x 9 mm
Upward
Cross-Serration



Aufricht
21 cm / 8¼"



22-1710-01

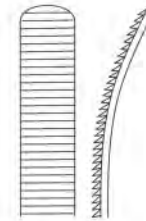

22-1710-02

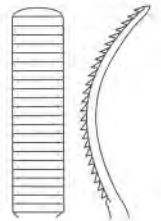

22-1710-03



Miller
18 cm / 7"

Nasenraspeln, Raspeln
 Escofinas Nasales, Escofinas
 Raspe Nasali, Raspe
 Nasal Rasps, Rasps



6.5 mm

22-1720-01
 Fine

7.5 mm



6.5 mm

22-1720-02
 Coarse

7.5 mm

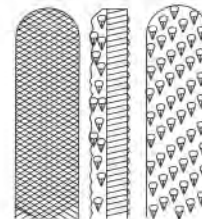

22-1730-21
 30 mm / 8 mm

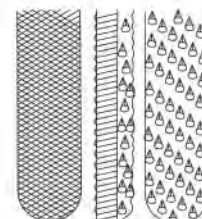

13 mm



Fomon
 21 cm / 8¼"

20 mm



18 mm

Putti
 22-1750-27
 27 cm / 10¾"

Fomon
 21 cm / 8¼"

10 mm



16 mm

Putti
 22-1760-30
 30 cm / 10¾"

22-1740-24
 24 cm / 9½"

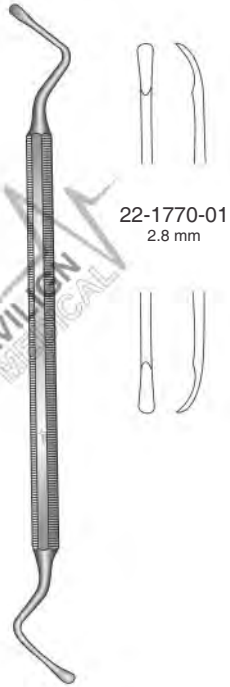

22-1770-01
2.8 mm



22-1770-02
3.2 mm



Lucas
18 cm / 7"



22-1780-01



22-1780-02



Hemingway
17 cm / 6 3/4"



22-1790-04 Ø 4 mm
22-1790-05 Ø 5 mm
22-1790-07 Ø 7 mm
22-1790-10 Ø 10 mm

Mod. Schweden
19.5 cm / 7 3/4"



22-1800-13 3.4 mm Fig. 1
22-1800-15 5.2 mm Fig. 2

Williger
17 cm / 6 3/4"



22-1810-13 13 cm / 5"
22-1810-16 16 cm / 6 1/4"
22-1810-20 20 cm / 8"

Volkman

Scharfe Löffel
 Cucharillas Cortantes
 Curette Per Ossa
 Bone Currettes



22-1820-14
 14 cm / 5½"

Jacobson



22-1830-01
 Fig. 00 / 0

22-1830-02
 Fig. 0 / 1

22-1830-03
 Fig. 1 / 2



Martini
 14 cm / 5½"



22-1840-01
 Fig. 00 / Fig. 0

22-1840-02
 Fig. 0 / Fig. 1

22-1840-03
 Fig. 1 / Fig. 2



Williger
 13 cm / 5"

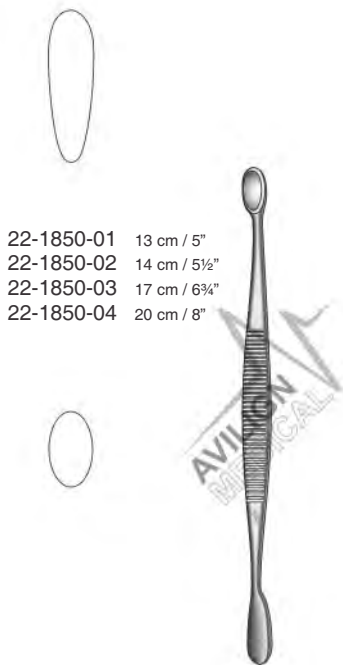

22-1850-01 13 cm / 5"
 22-1850-02 14 cm / 5½"
 22-1850-03 17 cm / 6¾"
 22-1850-04 20 cm / 8"

Volkmann



22-1860-18
 18 cm / 7"

Barth



22-1870-21
 21 cm / 8¼"



22-1880-05
Fig. 5



22-1880-06
Fig. 6



22-1890-05
Fig. 5



22-1890-06
Fig. 6



22-1880-03
Fig. 3



22-1880-04
Fig. 4



22-1890-03
Fig. 3



22-1890-04
Fig. 4



22-1880-01
Fig. 1



22-1880-02
Fig. 2



22-1890-01
Fig. 1



22-1890-02
Fig. 2



22-1880-20
Fig. 00



22-1880-10
Fig. 0



22-1890-20
Fig. 00



22-1890-10
Fig. 0



22-1880-40
Fig. 0000



22-1880-30
Fig. 000



22-1890-40
Fig. 0000



22-1890-30
Fig. 000



Volkmann
17 cm / 6¾"



Spratt
17 cm / 6¾"

Scharfe Löffel
 Cucharillas Cortantes
 Curette Per Ossa
 Bone Curettes



22-1900-05
 Fig. 5



22-1900-06
 Fig. 6



22-1900-03
 Fig. 3



22-1900-04
 Fig. 4



22-1900-01
 Fig. 1



22-1900-02
 Fig. 2



22-1900-20
 Fig. 00



22-1900-10
 Fig. 0



22-1900-30
 Fig. 000



22-1910-06
 3.3 mm



22-1910-05
 3 mm



22-1910-04
 2.7 mm



22-1910-03
 2.4 mm



22-1910-02
 2 mm



22-1910-01
 1.7 mm



22-1910-00
 1 mm



Spratt
 20 cm / 8"



Lempert
 21 cm / 8¼"



22-1930-05
Fig. 5



22-1930-06
Fig. 6



22-1920-06
6.8 mm



22-1930-03
Fig. 3



22-1930-04
Fig. 4



22-1920-05
5.2 mm



22-1930-01
Fig. 1



22-1930-02
Fig. 2



22-1940-02



22-1920-04
4.4 mm



22-1930-20
Fig. 00



22-1930-10
Fig. 0



22-1940-00



22-1920-03
3.6 mm



22-1930-40
Fig. 0000



22-1930-30
Fig. 000



22-1940-01



25 cm / 9 3/4"



Simon
24 cm / 9 1/2"



Scoville
25 cm / 9 3/4"

Scharfe Löffel
 Cucharillas Cortantes
 Curette Per Ossa
 Bone Currettes



22-1950-05
 Fig. 5



22-1950-06
 Fig. 6



22-1960-05
 Fig. 5



22-1960-06
 Fig. 6



22-1950-03
 Fig. 3



22-1950-04
 Fig. 4



22-1960-03
 Fig. 3



22-1960-04
 Fig. 4



22-1950-01
 Fig. 1



22-1950-02
 Fig. 2



22-1960-01
 Fig. 1



22-1960-02
 Fig. 2



22-1950-20
 Fig. 00



22-1950-10
 Fig. 0



22-1960-20
 Fig. 00



22-1960-10
 Fig. 0



22-1950-40
 Fig. 0000



22-1950-30
 Fig. 000



22-1960-40
 Fig. 0000



22-1960-30
 Fig. 000



Brun's
 23 cm / 9"



Brun's
 23 cm / 9"



22-1970-10
9.5 cm / 3¾"

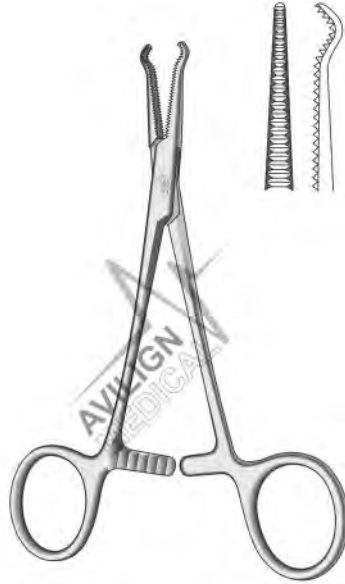

22-1980-14
14 cm / 5½"



22-1990-13
13.5 cm / 5¼"



Lewin
22-2000-17
17.5 cm / 7"



22-2010-20
20.5 cm / 8"

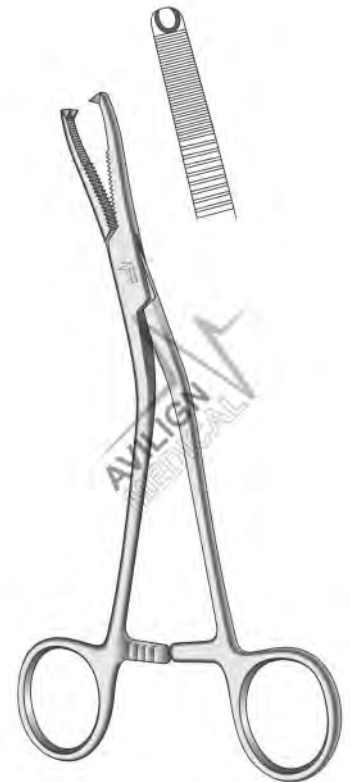

Dingmann
22-2020-18
18.5 cm / 7¼"
Bone Holding Forceps

Patellazangen, Knochenhaltezange, Sequesterzangen
 Pinza Para Rotula, Pinza Para Huesos, Pinzas Para Secuestro
 Pinza Per Rotula, Tenaglie Per Ossa, Pinze Per Frammento Osseo
 Patella Forceps, Bone Holding Forceps, Sequestrum Forceps



22-2030-18 18.5 cm / 7¼"
 22-2030-21 21 cm / 8¼"

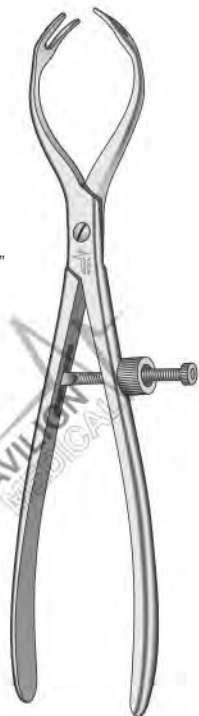

Patella Forceps



22-2040-17
 17 cm / 6¾"



22-2040-23
 23.5 cm / 9¼"



Bone Holding Forceps



22-2050-20
 20 cm / 8"
 Sequestrum Forceps



Van Buren
 22-2060-23
 23 cm / 9"
 Sequestrum Forceps



22-2070-20
 5 mm



Langenbeck
 20 cm / 8"
 Bone Holding Forceps



Semb
22-2080-19
19 cm / 7½"
8 mm



Kern-Lane

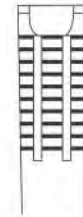

- 22-2090-15 15 cm / 6"
- 22-2090-17 17 cm / 6¾"
- 22-2090-21 21 cm / 8¼"
- 22-2090-24 24 cm / 9½"



Farabeuf
Adjustable

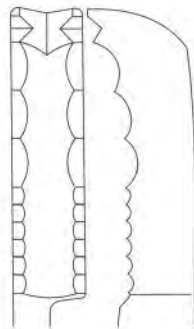

- 22-2100-23 9 mm
23 cm / 9"
- 22-2100-25 11 mm
25.5 cm / 10"

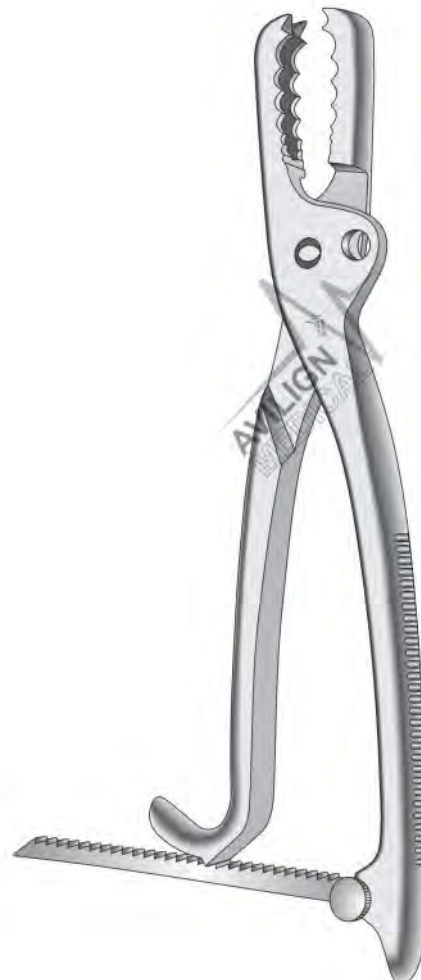

Farabeuf-Lambotte
25.5 cm / 10"

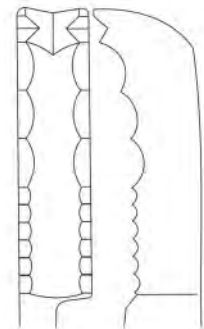

- 22-2110-25
11 mm
Adjustable

Knochenhaltezaugen
 Pinzas Para Huesos
 Tenaglie Per Ossa
 Bone Holding Forceps

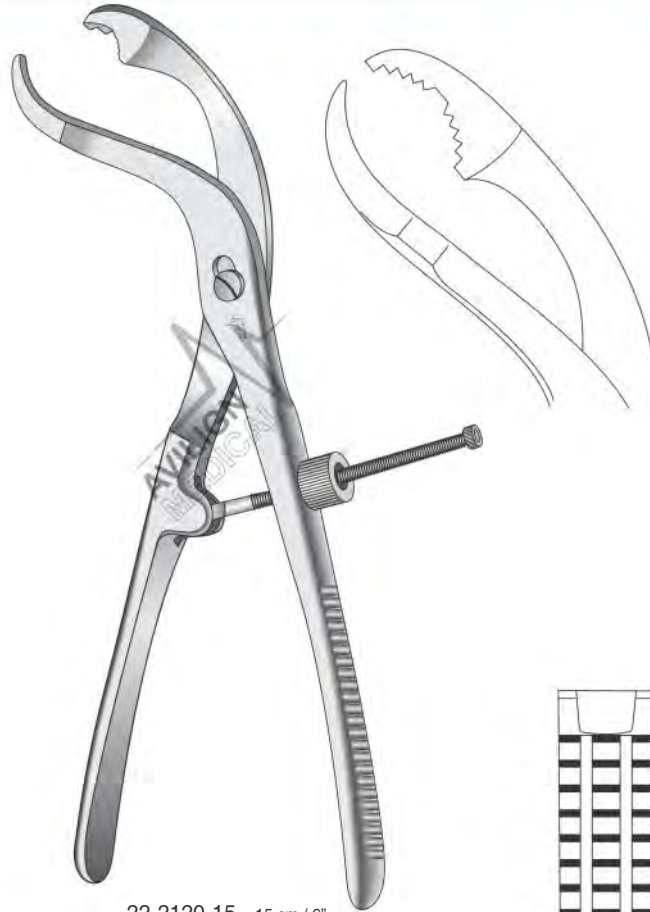

- 22-2120-15 15 cm / 6"
- 22-2120-19 19 cm / 7½"
- 22-2120-24 24 cm / 9½"
- 22-2120-26 26 cm / 10½"
- 22-2120-28 28 cm / 11"
- Self-Centering

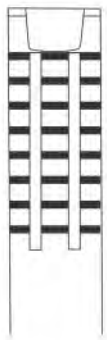

22-2130-33
 33 cm / 13"

22-2130-45
 45 cm / 17¾"

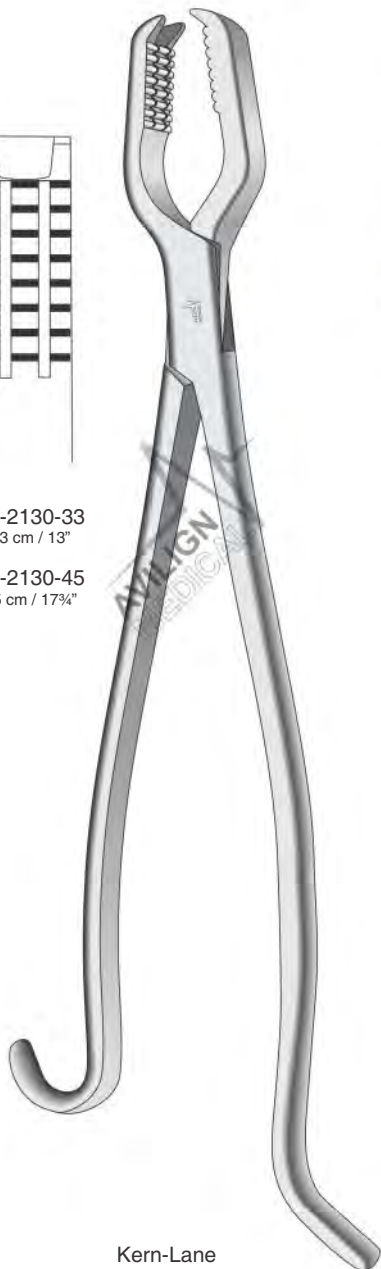

Kern-Lane



22-2140-33
 33 cm / 13"

22-2140-45
 45 cm / 17¾"

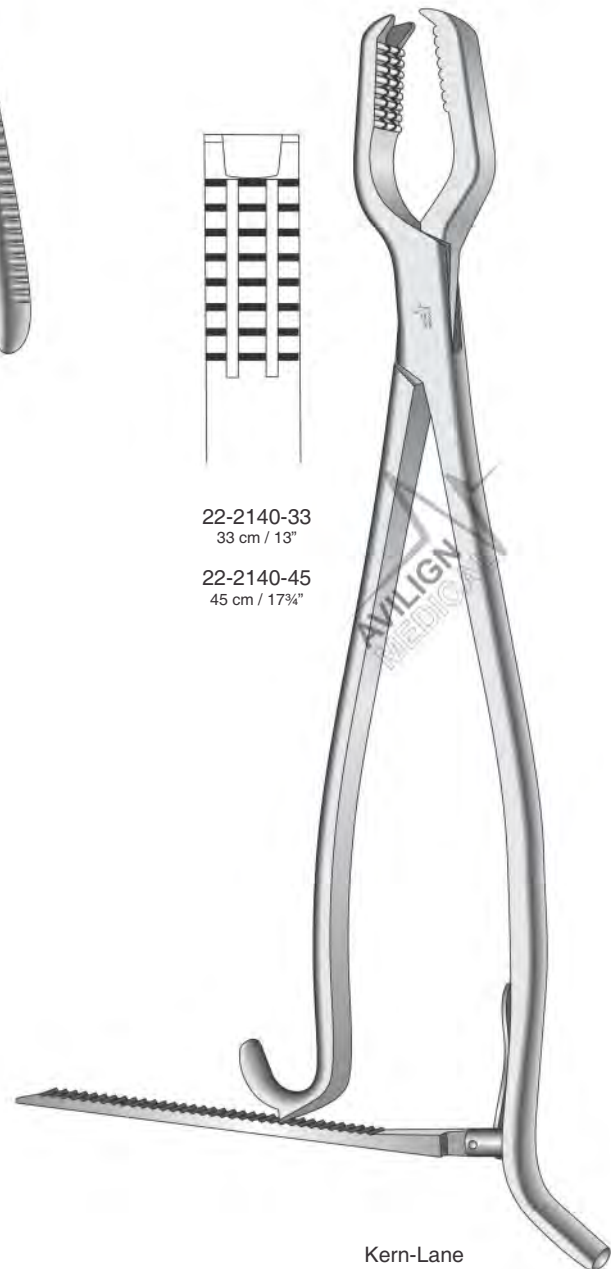

Kern-Lane



Lowman

- 22-2150-12 12 cm / 4¾"
- 22-2150-18 18 cm / 7"
- 22-2150-20 20 cm / 8"
- 22-2150-22 22 cm / 8¾"



Lowman-Hoglund

- 22-2160-12 12 cm / 4¾"
- 22-2160-18 18 cm / 7"
- 22-2160-20 20 cm / 8"



22-2170-01
1.2 mm
Slightly Curved



22-2180-02
1.2 mm
Curved

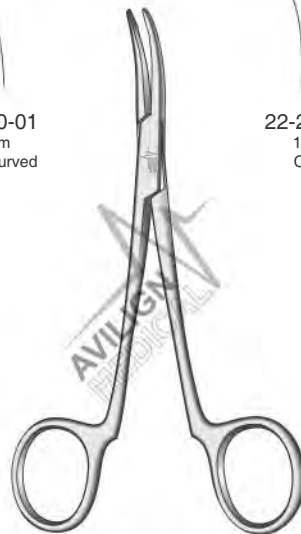

13 cm / 5"

Hohlmeißelzangen
 Pinzas-Gubias
 Pinze Per Ossa
 Bone Rongeurs



22-2190-14
 14 cm / 5 1/2"

Kleinert-Kutz

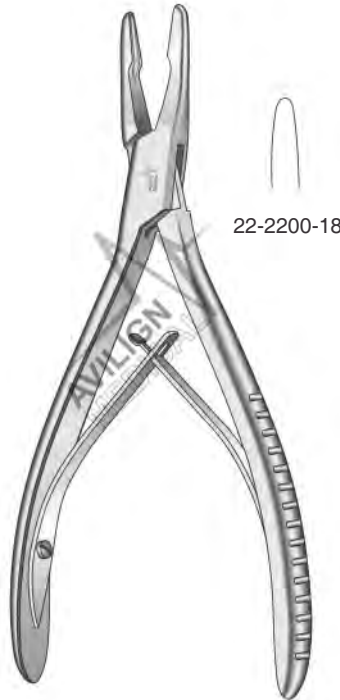

22-2200-18

Heanley



22-2210-01
 17.5 cm / 8"
 Slightly Curved



22-2210-02
 16.5 cm / 6 1/2"
 Curved

Stellbrink

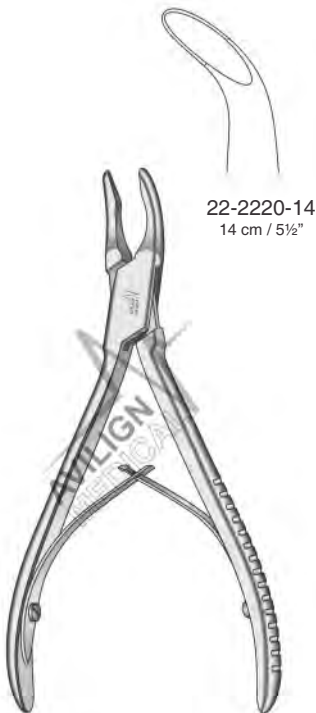

22-2220-14
 14 cm / 5 1/2"



22-2230-01

Luer
 15 cm / 6"



22-2230-02

22-2230-03

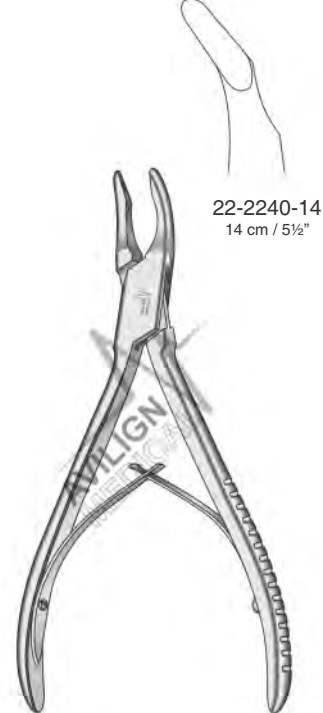

22-2240-14
 14 cm / 5 1/2"

Cleveland

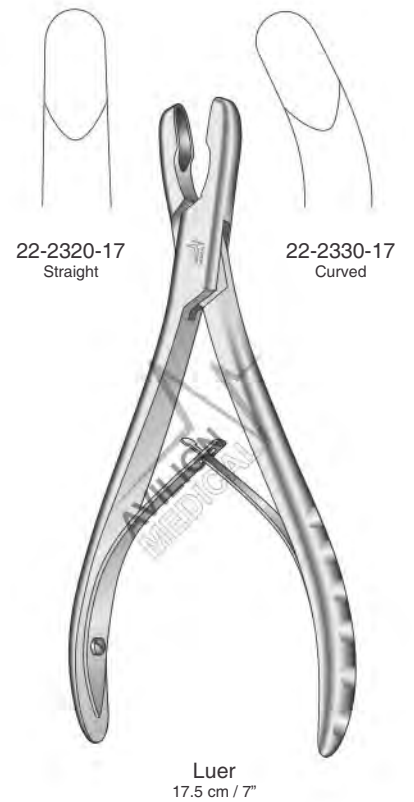
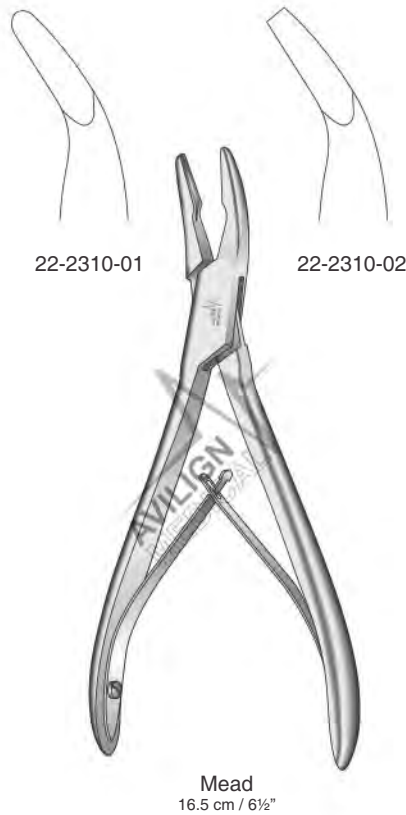
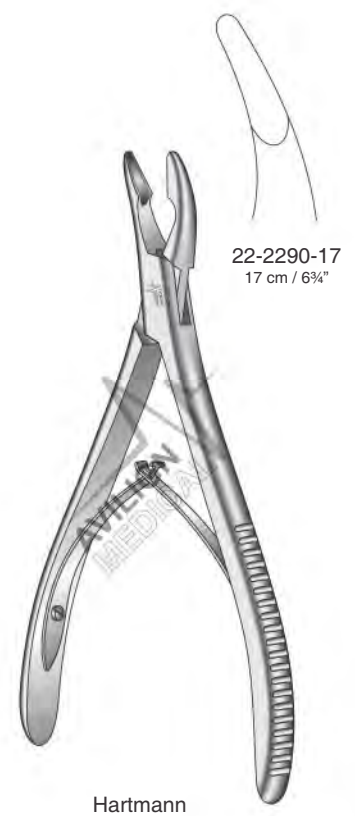
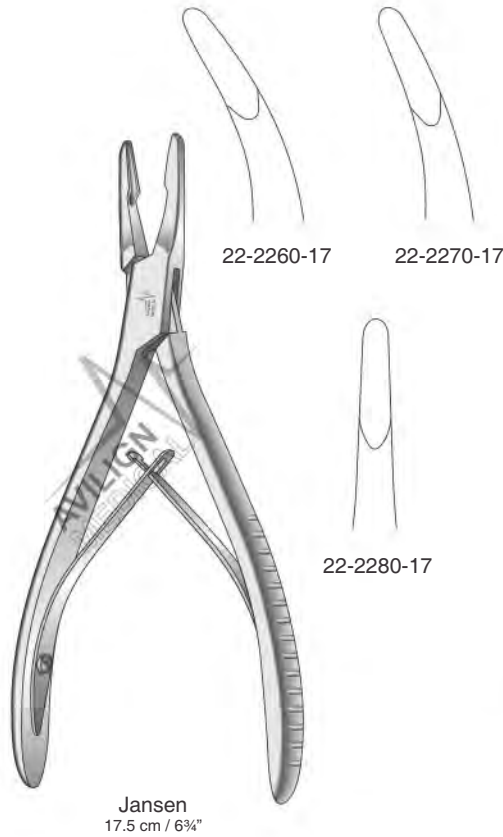
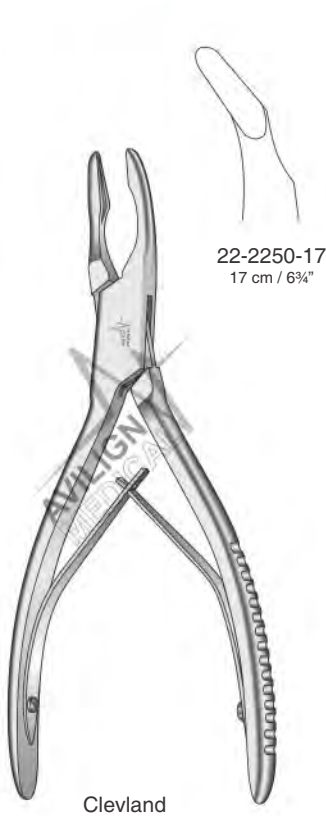

Hohlmeißelzangen
 Pinzas-gubias
 Pinze Per Ossa
 Bone Rongeurs

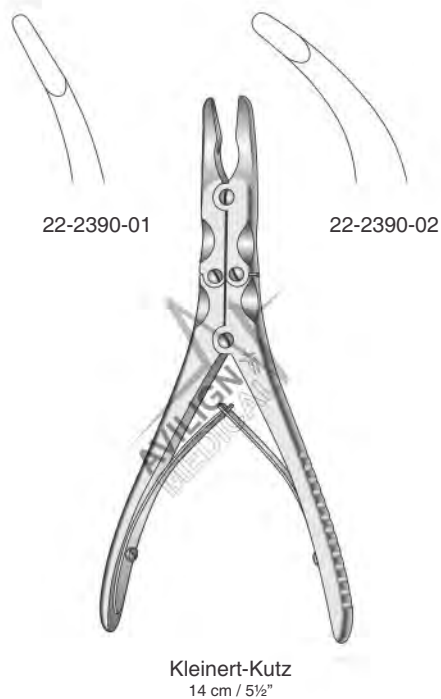
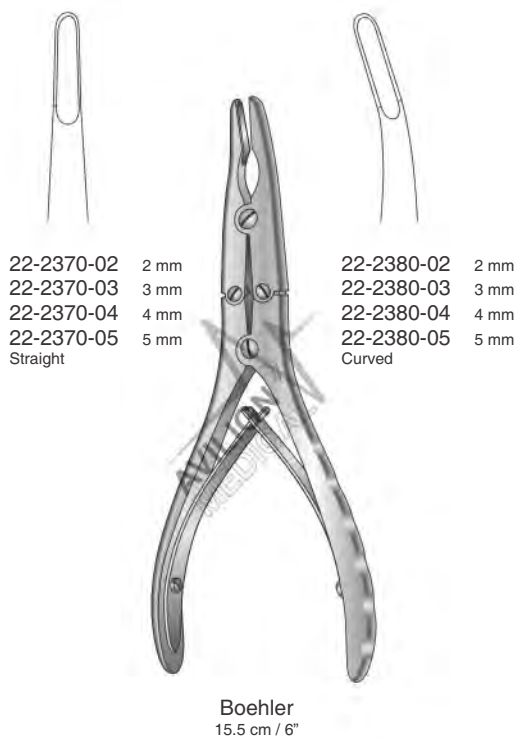
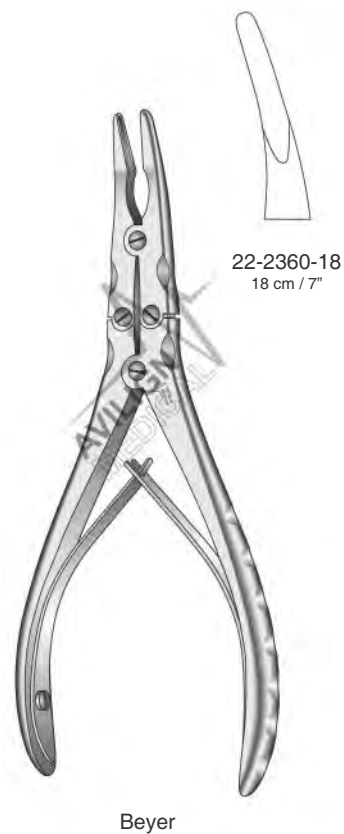
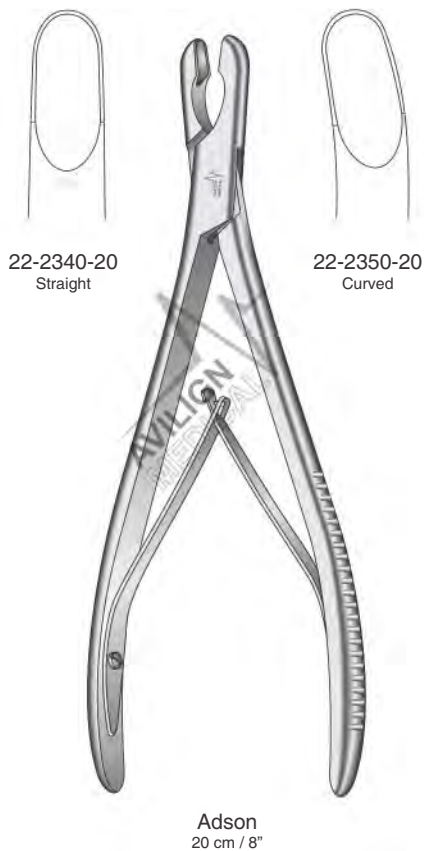

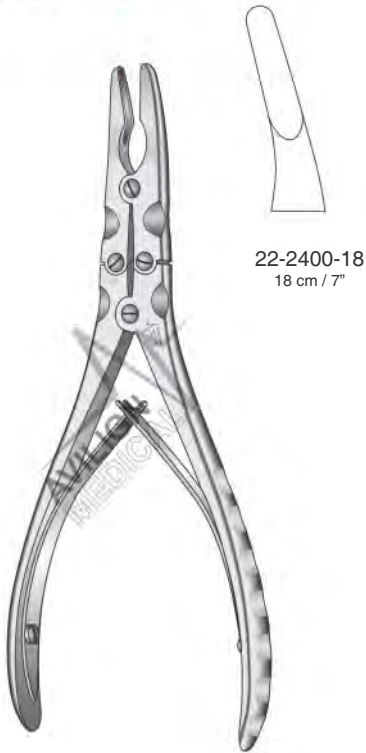

22-2400-18
18 cm / 7"

Zaufal-Jansen

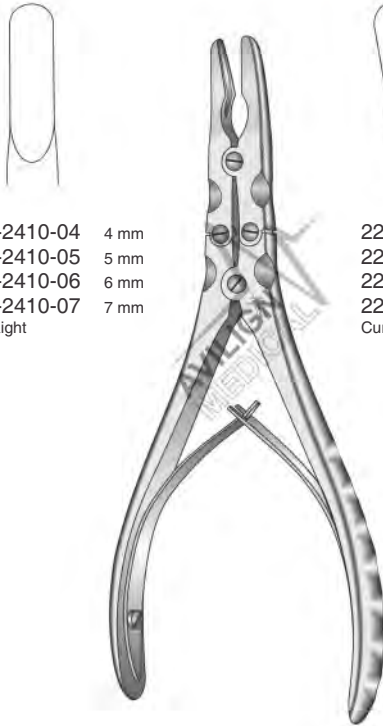

22-2410-04 4 mm
22-2410-05 5 mm
22-2410-06 6 mm
22-2410-07 7 mm
Straight

22-2420-04 4 mm
22-2420-05 5 mm
22-2420-06 6 mm
22-2420-07 7 mm
Curved

Ruskin
18 cm / 7"

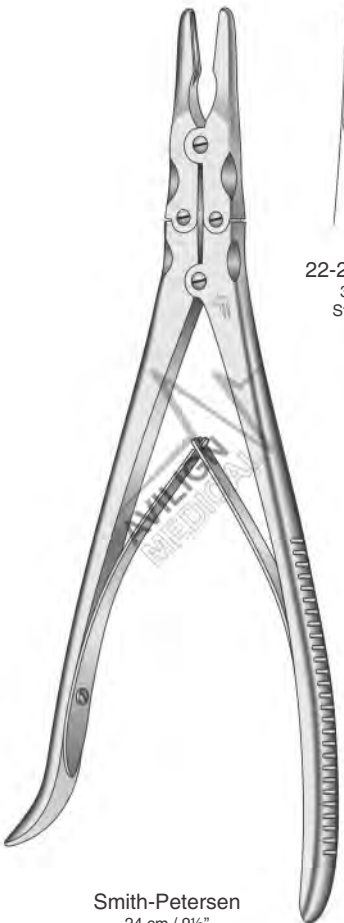

22-2430-01
3 mm
Straight

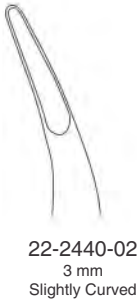

22-2440-02
3 mm
Slightly Curved



22-2450-03
3 mm
Curved

Smith-Petersen
24 cm / 9½"

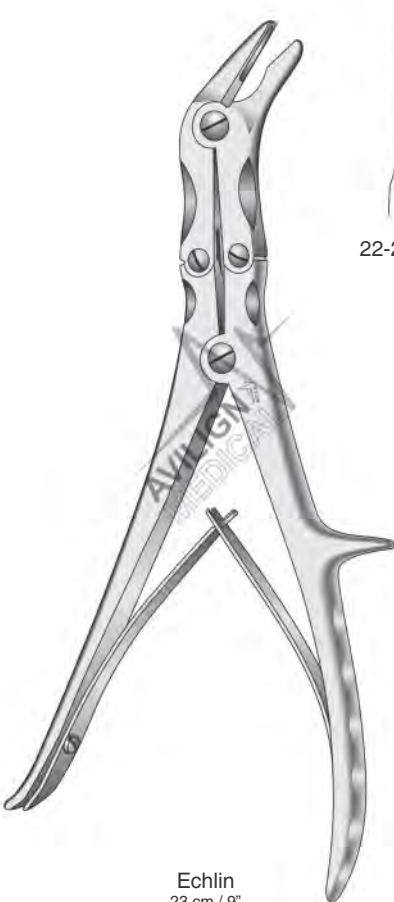

22-2460-02
2 mm



22-2460-03
3 mm



22-2460-04
4 mm

Echlin
23 cm / 9"

Hohlmeißelzangen
 Pinzas-Gubias
 Pinze Per Ossa
 Bone Rongeurs

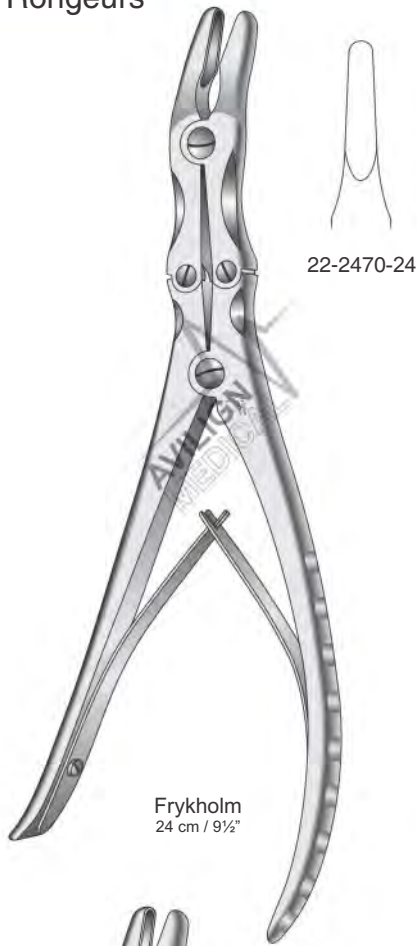

Frykholm
 24 cm / 9½"



Stille
 23 cm / 9"

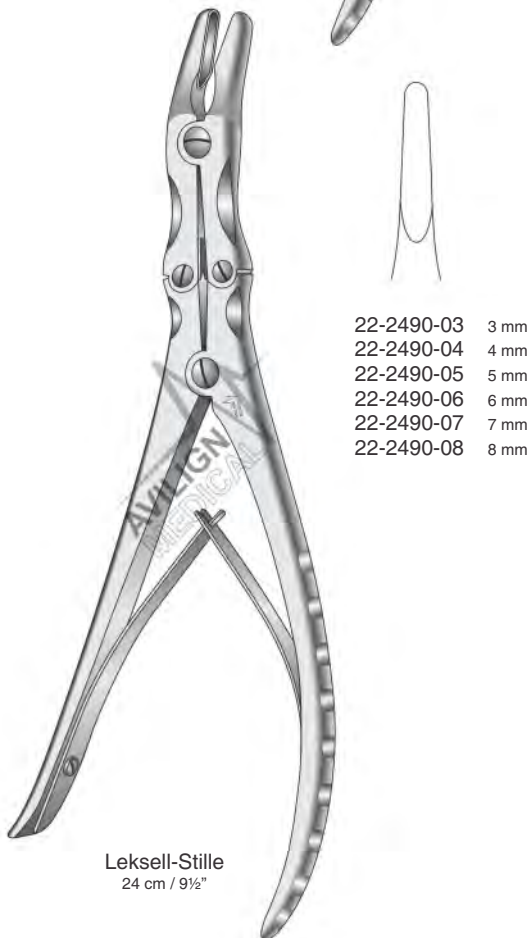

Leksell-Stille
 24 cm / 9½"

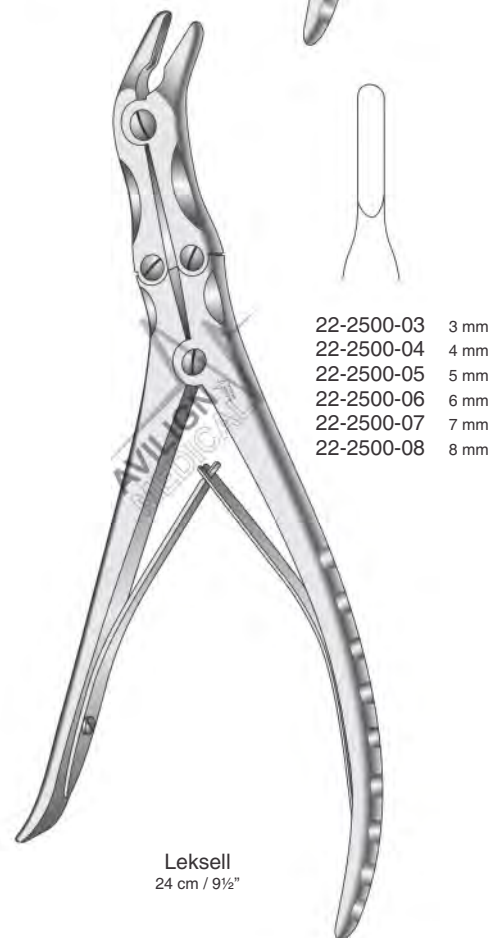

Leksell
 24 cm / 9½"

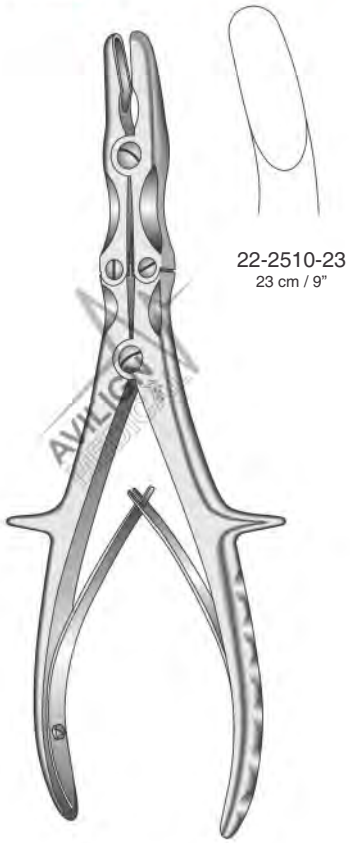

22-2510-23
23 cm / 9"

Stille-Ruskin

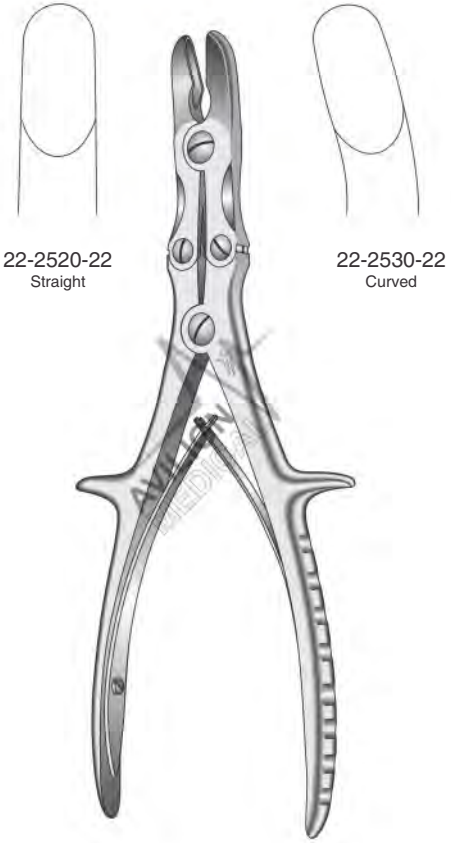

22-2520-22
Straight

22-2530-22
Curved

Luer-Stille
22 cm / 8 3/4"

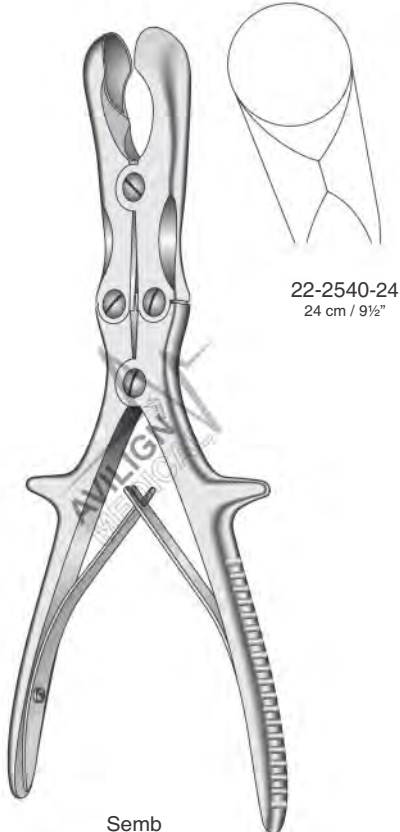

22-2540-24
24 cm / 9 1/2"

Semb

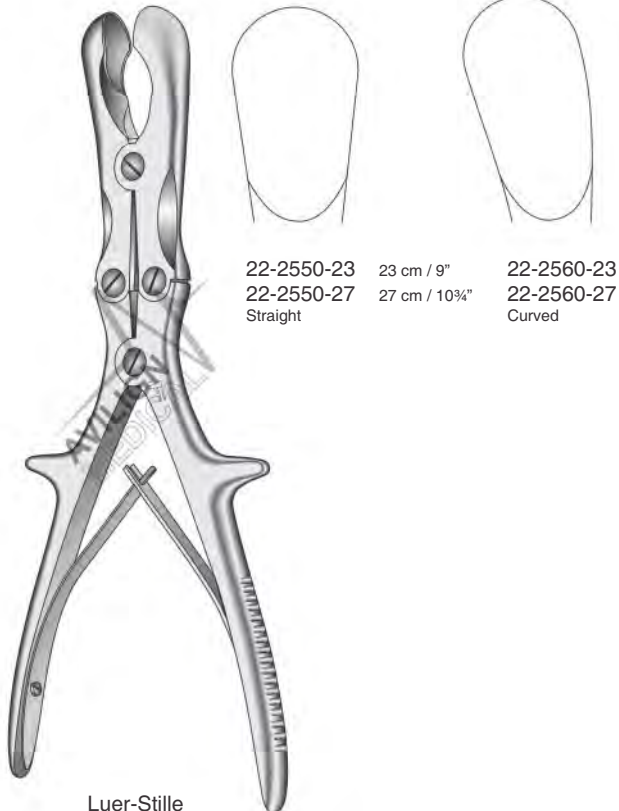

22-2550-23
22-2550-27
Straight

23 cm / 9"
27 cm / 10 3/4"

22-2560-23
22-2560-27
Curved

Luer-Stille

Knochensplitterzangen
 Pinzas Cortantes Para Huesos
 Cesoie Per Ossa
 Bone Cutting Forceps

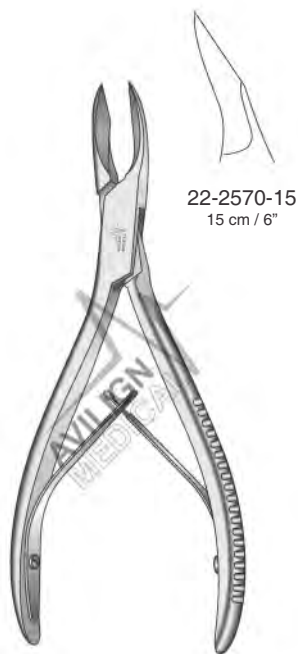

22-2570-15
 15 cm / 6"

Cleveland

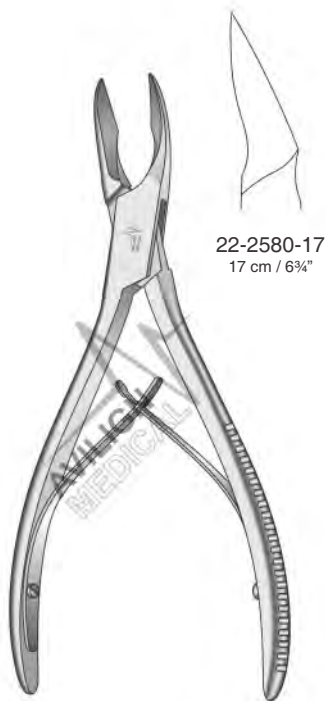

22-2580-17
 17 cm / 6 3/4"

Cleveland

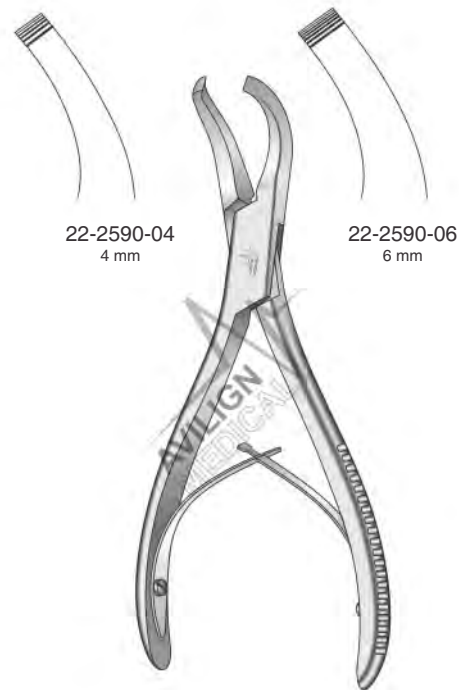

22-2590-04
 4 mm

22-2590-06
 6 mm

Gardner
 16 cm / 6 1/4"

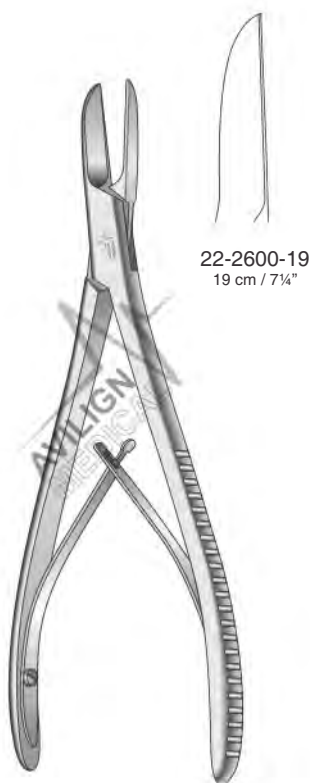

22-2600-19
 19 cm / 7 1/4"

Cottle-Kazanjan

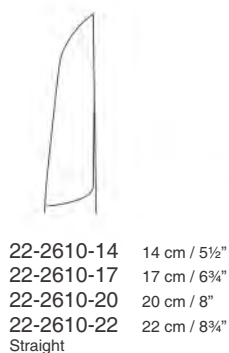

22-2610-14 14 cm / 5 1/2"
 22-2610-17 17 cm / 6 3/4"
 22-2610-20 20 cm / 8"
 22-2610-22 22 cm / 8 3/4"
 Straight

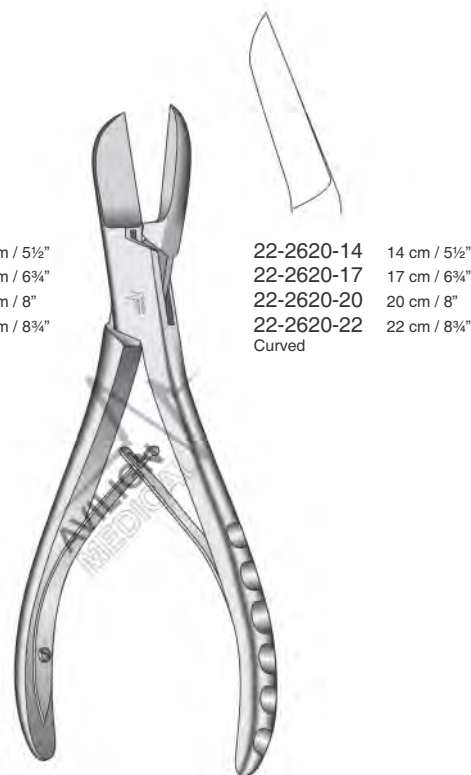

22-2620-14 14 cm / 5 1/2"
 22-2620-17 17 cm / 6 3/4"
 22-2620-20 20 cm / 8"
 22-2620-22 22 cm / 8 3/4"
 Curved

Liston



22-2630-15



22-2640-15

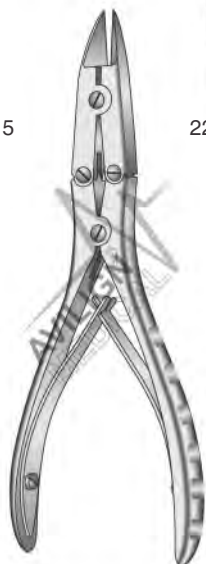

Boehler
14.5 cm / 5¾"

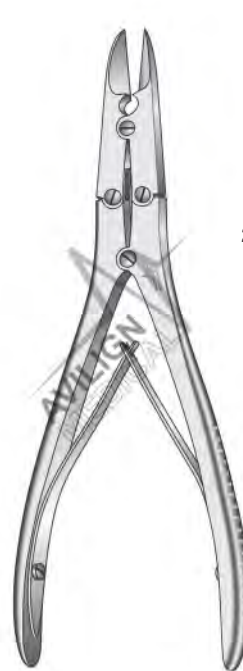

22-2650-17
17 cm / 6¾"



22-2660-19
Straight



22-2670-19
Curved



Ruskin-Liston
19 cm / 7½"



22-2680-18
17.5 cm / 7"

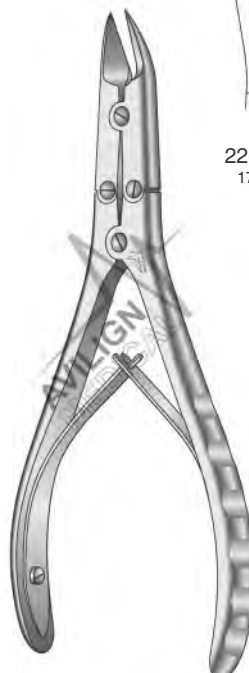

Mc Indoe

Knochensplitterzangen
 Pinzas Cortantes Para Huesos
 Cesoie Per Ossa
 Bone Cutting Forceps

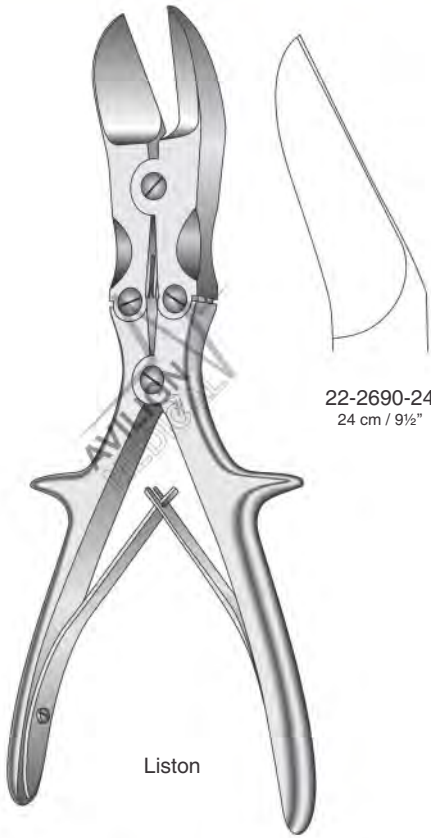

22-2690-24
 24 cm / 9½"

Liston



22-2700-26
 25.5 cm / 10"

Liston-Key

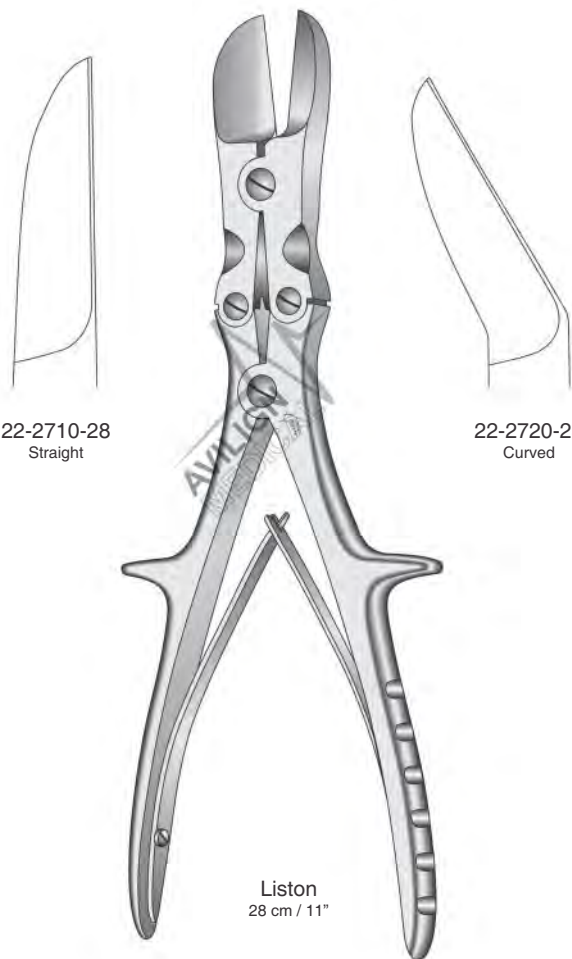

22-2710-28
 Straight

Liston
 28 cm / 11"

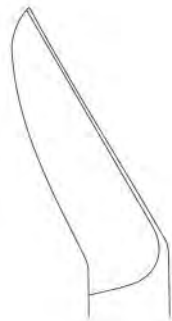

22-2720-28
 Curved

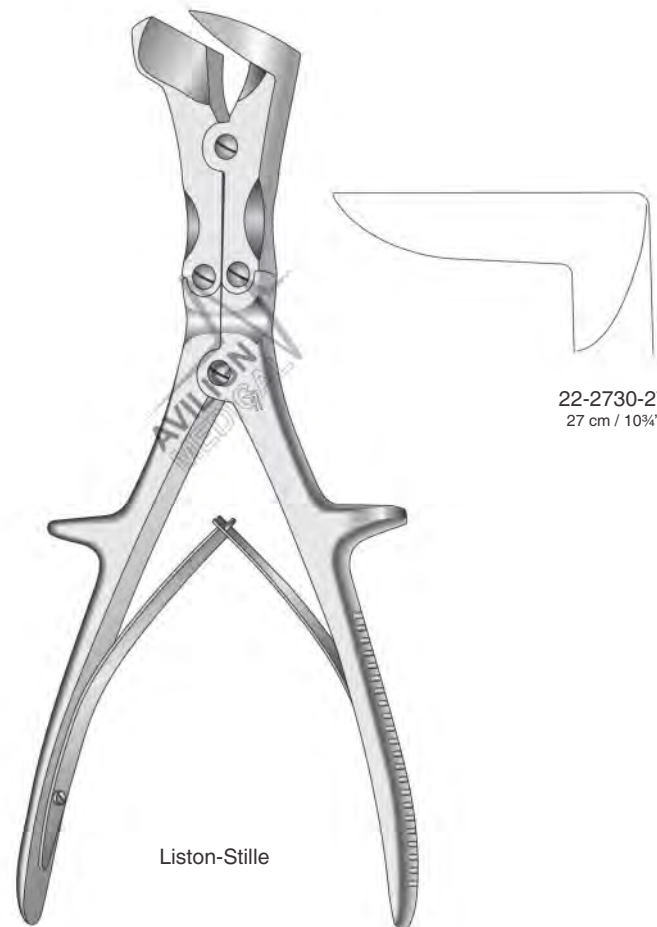

22-2730-27
 27 cm / 10¾"

Liston-Stille

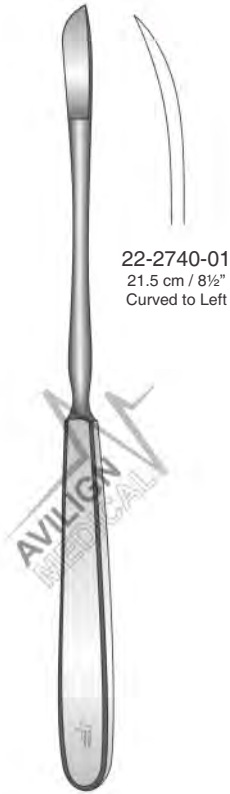

22-2740-01
 21.5 cm / 8½"
 Curved to Left

Neff



22-2740-02
 21.5 cm / 8½"
 Curved to Right

Neff

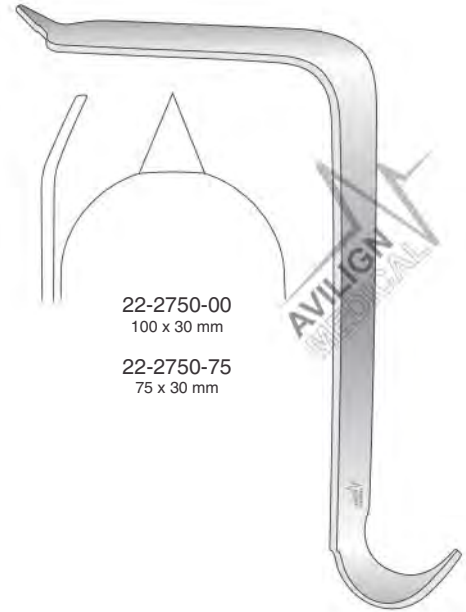

22-2750-00
 100 x 30 mm

22-2750-75
 75 x 30 mm

Taylor
 16.5 cm / 6¼"



56 x 10 mm

22-2760-17
 17 cm / 6¾"

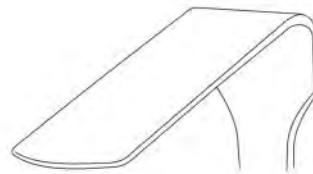

22-2770-01 32 x 19 mm
 22-2770-02 48 x 19 mm
 22-2770-03 57 x 19 mm

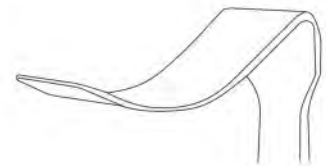

22-2780-01
 52 x 13 mm



22-2790-01 12 x 13 mm
 22-2790-02 13 x 25 mm



Smillie
 14 cm / 5½"

Smillie
 22-2800-00
 Set

Sehnenflechklemmen, Extensionsbügel, Drahtumführungsnadeln
 Pinzas Para Entrelazertendones, Estribos Para Extensión, Agujas Pasa-hilos
 Pinze Per Allaciare Tendini, Archi Oer Trazione, Guida Cavo
 Tendon Interlacing Forceps, Wire Traction Bows, Wire Guides



Jackson
 22-2810-15
 15 cm / 6"
 4 x 5 Teeth

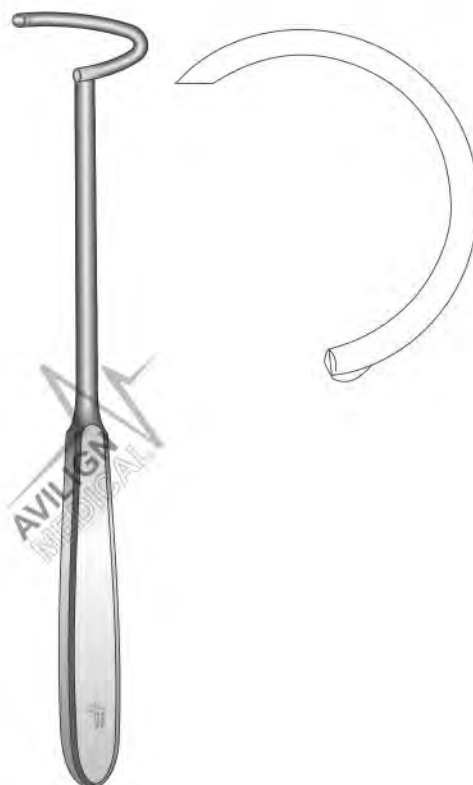

22-2820-22
 22.5 cm / 9"

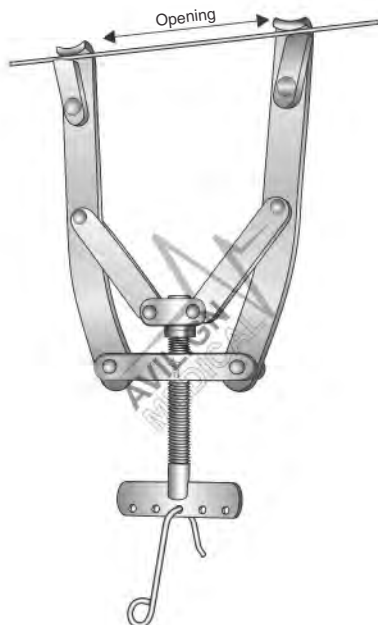

Kirschner
 22-2830-01 130 mm Opening
 22-2830-02 185 mm Opening
 22-2830-03 220 mm Opening

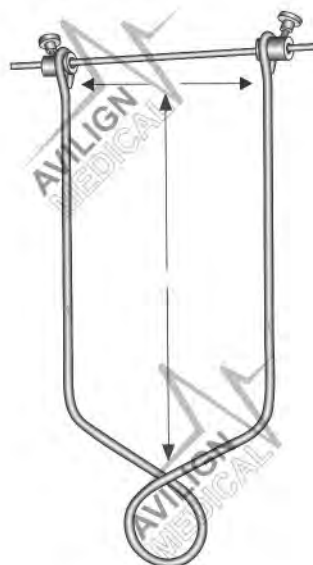

Kirschner L x D
 22-2840-01 90 x 160 mm
 22-2840-02 110 x 210 mm
 22-2840-03 150 x 210 mm



Tungsten Carbide
Gold Rings

22-2850-20
20 cm / 8"

Baumgartner



22-2860-15
15 cm / 6"



22-2860-18
18 cm / 7"

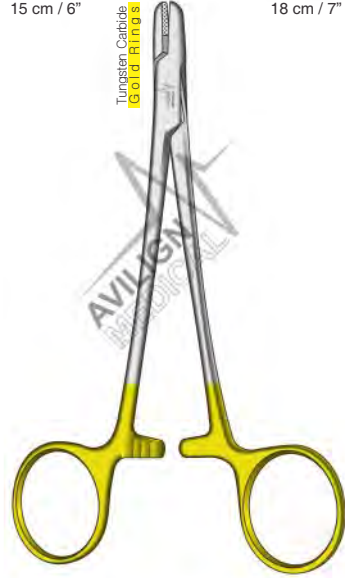

Tungsten Carbide
Gold Rings



Tungsten Carbide
Gold Rings



22-2870-15
15 cm / 6"



22-2870-18
18 cm / 7"



22-2870-20
20 cm / 8"

Drahtzangen
 Pinzas Para Extraer Alambres
 Pinze Porta Cavo
 Wire Forceps

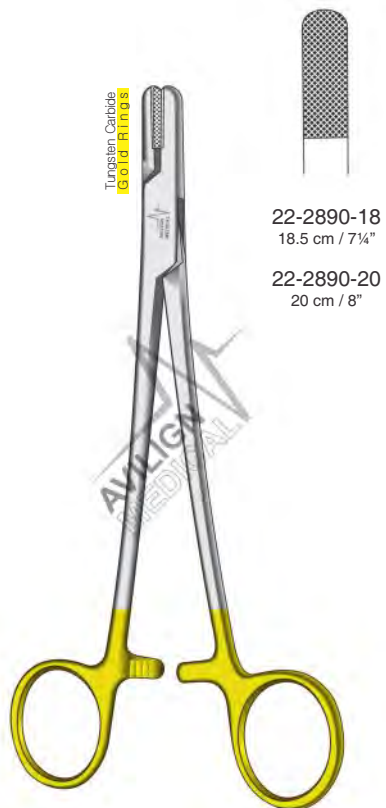
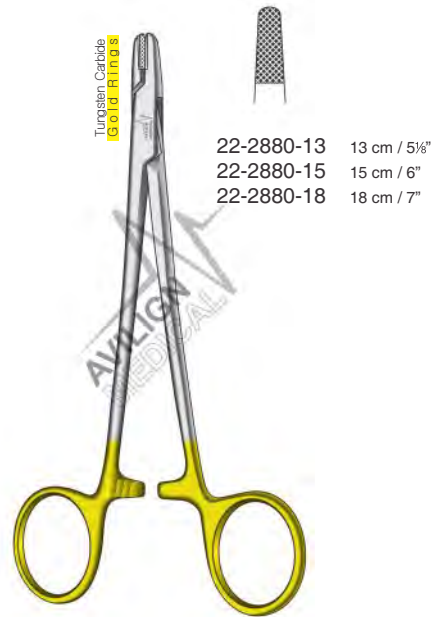

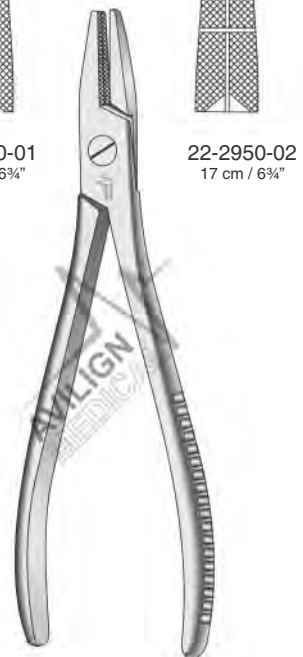
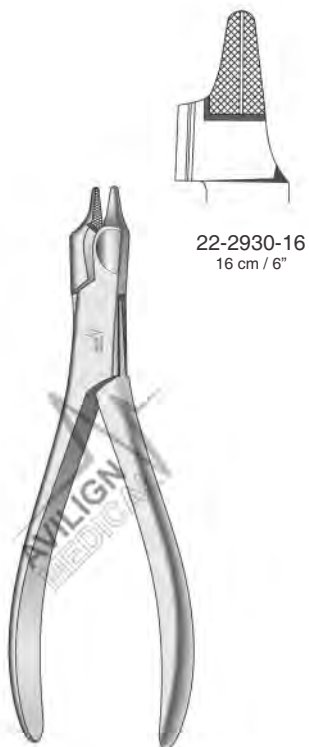
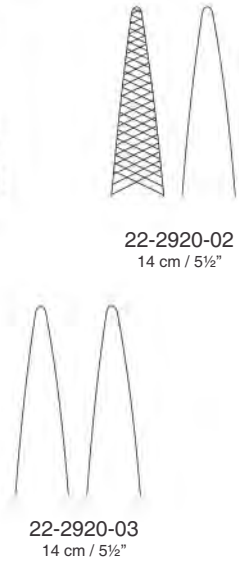
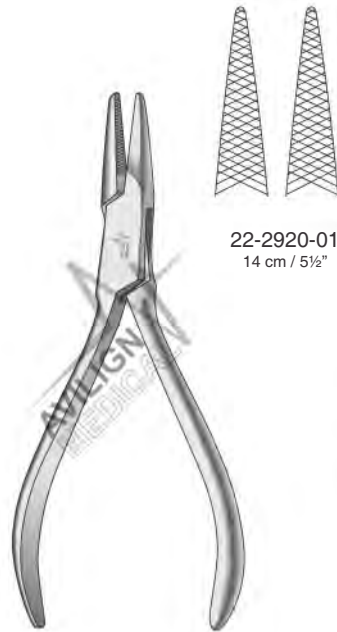

Hackstock

Drahtzangen
 Pinzas Para Extraer Alambres
 Pinze Porta Cavo
 Wire Forceps



22-2960-18
 18 cm / 8"



22-2970-14
 14.5 cm / 5¾"

22-2980-01
 18 cm / 7"

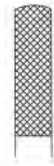

22-2980-02
 18 cm / 7"

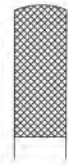

22-2980-03
 18 cm / 7"

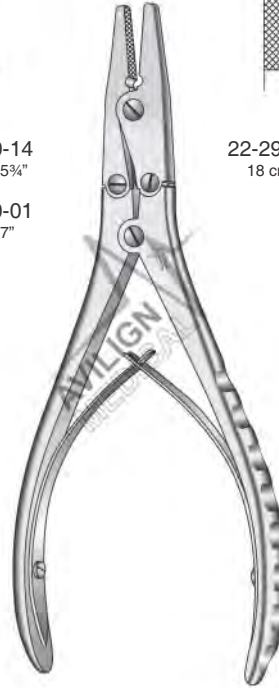

22-2990-19
 19 cm / 7½"

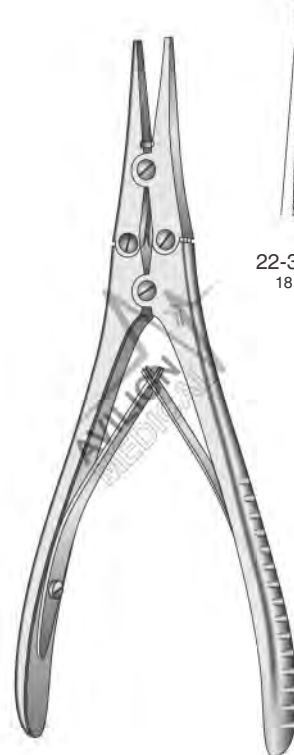

22-3000-18
 18 cm / 7"

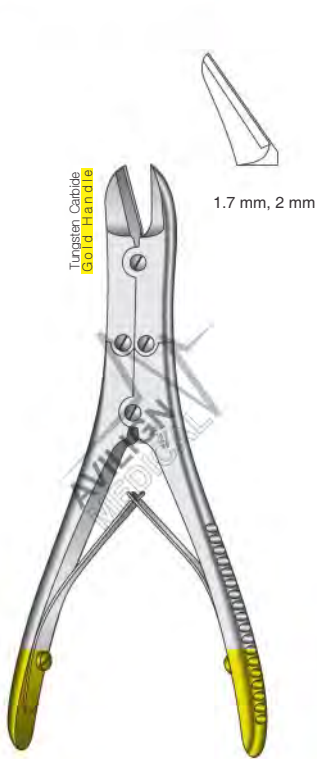

1.7 mm, 2 mm

Tungsten Carbide
Gold Handle

22-3010-16 16 cm / 6¼"
22-3010-18 18 cm / 7"

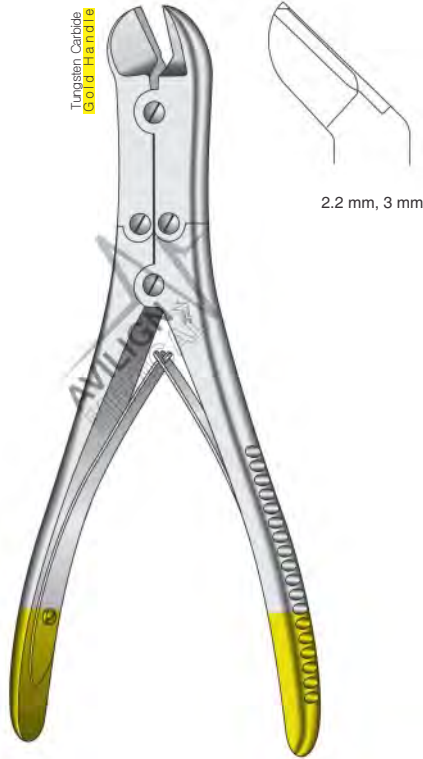

2.2 mm, 3 mm

Tungsten Carbide
Gold Handle

22-3020-22
22 cm / 8¾"

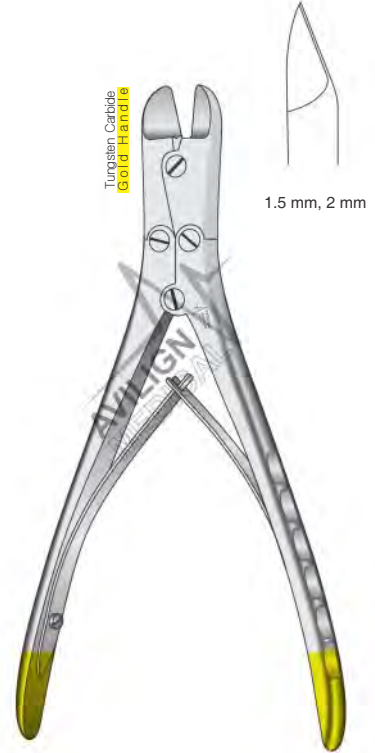

1.5 mm, 2 mm

Tungsten Carbide
Gold Handle

Reill
22-3030-17
17.5 cm / 7"

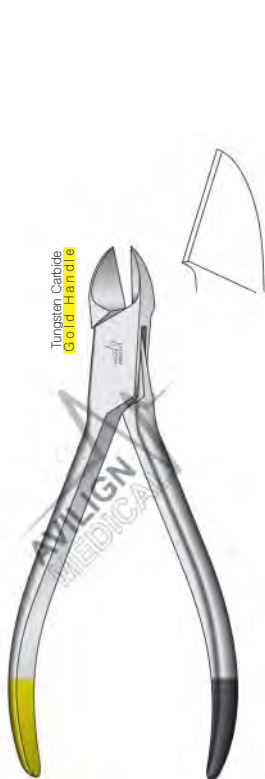

Tungsten Carbide
Gold Handle

22-3040-14
14 cm / 5½"
1 mm, 1.5 mm

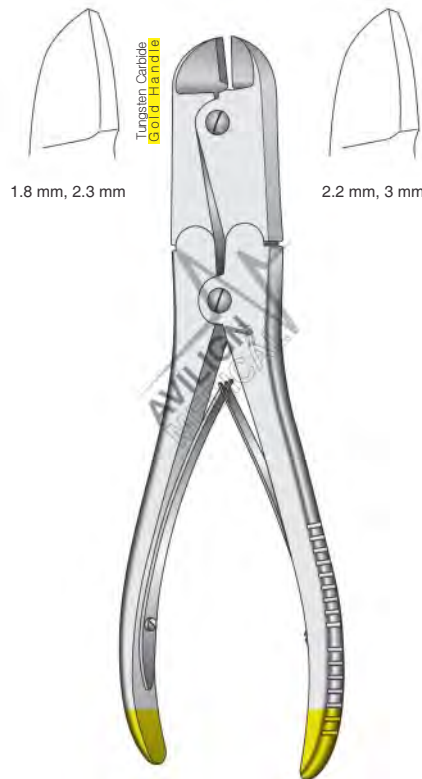

1.8 mm, 2.3 mm

2.2 mm, 3 mm

Tungsten Carbide
Gold Handle

22-3050-17 17 cm / 6¾"
22-3050-23 23.5 cm / 9¼"



Tungsten Carbide
Gold Handle

1 mm

22-3060-16
16 cm / 6¼"

Drahtkneifzangen
 Alicates Corta-Alambres
 Tenaglie Tagliafili
 Wire Cutting Forceps



1.6 mm, 2.4 mm
 Cannulated

22-3070-18
 18 cm / 7"



22-3080-14
 14.5 cm / 5 3/4"
 1.0 mm, 1.5mm



22-3090-16
 16 cm / 6 1/4"
 2 mm, 2.2 mm

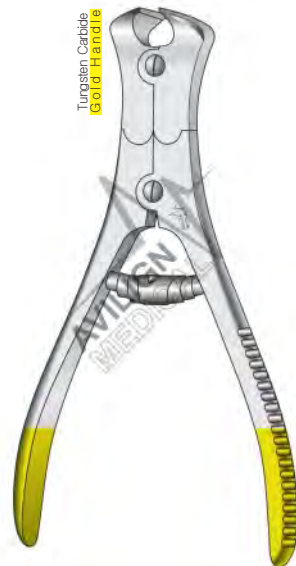

Tungsten Carbide
 Gold Handle

22-3100-14
 14.5 cm / 5 3/4"
 1.5 mm, 2 mm

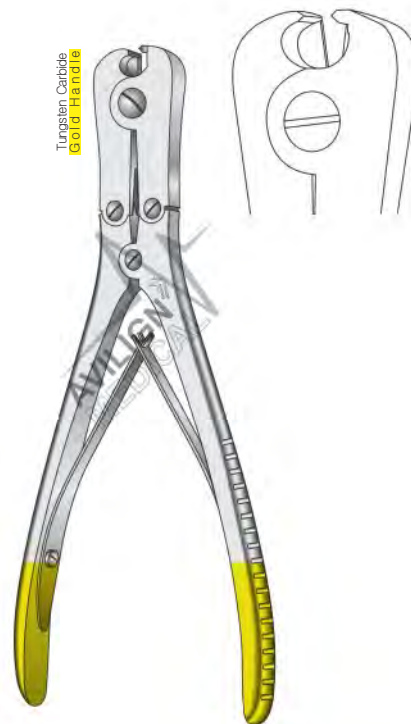

Tungsten Carbide
 Gold Handle

22-3110-18
 18 cm / 7"
 1.5 mm, 2 mm

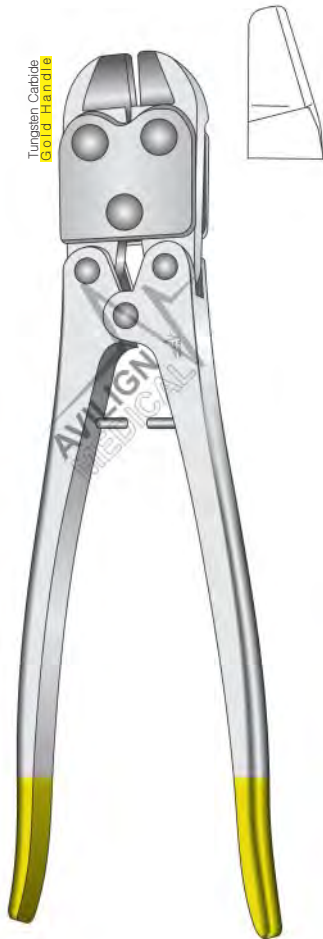

22-3120-23
23 cm / 9"



22-3130-47 47 cm / 18 1/4"
22-3130-54 56 cm / 22"
22-3130-58 58 cm / 23"
6 mm



22-3140-48 48 cm / 18 3/4"
22-3140-57 57 cm / 22 1/2"
6 mm
Detachable Handles



22-3150-39
38 cm / 15"
3.2 mm, 4.7 mm

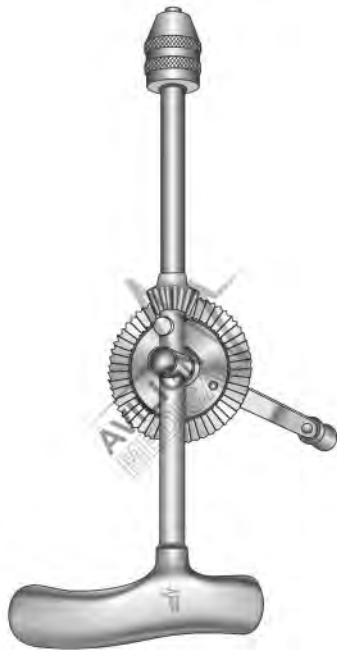

Moore
22-3160-00
27.5 cm / 10¾"

Complete, Including Set Of Drills 22-3170-00



22-3170-01
3.2 x 70 mm



22-3170-02
3.2 x 70 mm



22-3170-03
3.2 x 90 mm

22-3170-00
Set of Drills

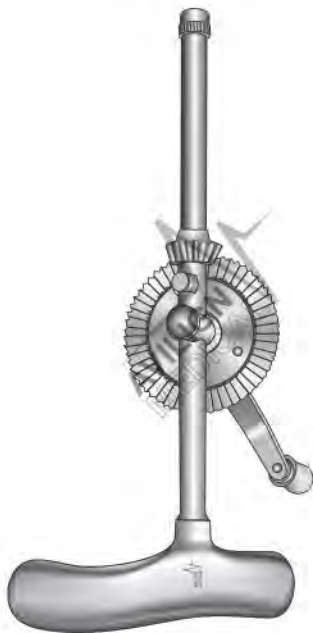

Stille-Sherman
22-3180-00
25 cm / 9¾"

Complete, Including Set Of Drills 22-3190-00



22-3190-01
Ø 2.5 mm



22-3190-02
Ø 3 mm



22-3190-03
Ø 3.5 mm

22-3190-00
Set of Drills

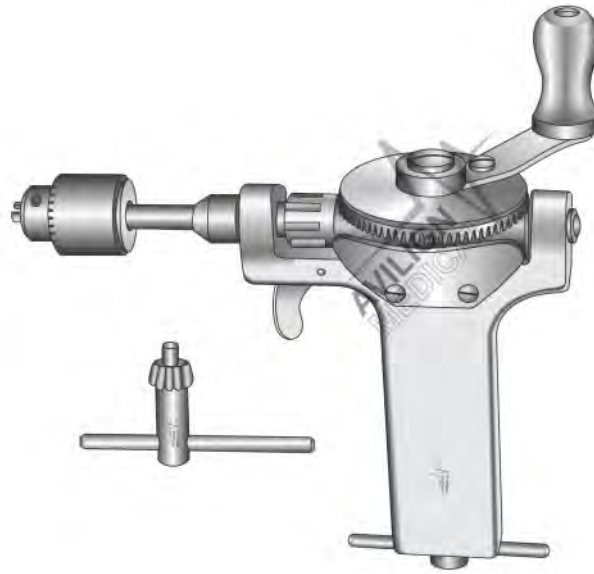

Bunnell
22-3200-00
Hand Drill with Key



Hudson
22-3210-00
28 cm / 11"
Hand Drill Set



22-3230-01
Ø 9 mm



22-3230-02
Ø 14 mm



22-3230-03
Ø 16 mm



22-3230-04
Ø 22 mm



22-3230-05
Ø 13 mm



22-3230-06
Ø 2.4 mm



22-3230-07
Ø 13 mm



22-3230-08
Ø 15 mm



22-3230-09
Extension Piece



23

Hands, Foot Surgery

Hand-und Fuß chirurgie

Cirurgia de mano y pie

Chirurgia della mano e piede



Mannerfelt
23-0010-13
13.5 cm / 5¼"



Mannerfelt
23-0020-15
15.5 cm / 6"



Mannerfelt
23-0030-15
15.5 cm / 6"
3.5 x 12 mm



Mannerfelt
23-0040-15
15.5 cm / 6"
4 x 7.2 mm
Flexible



Mannerfelt
15.5 cm / 6"



23-0050-01
Sharp

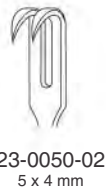

23-0050-02
5 x 4 mm
Sharp

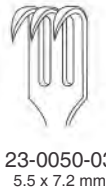

23-0050-03
5.5 x 7.2 mm
Sharp



23-0060-01
Blunt



23-0060-02
5 x 4 mm
Blunt



23-0060-03
5.5 x 7.2 mm
Blunt



Mannerfelt
15.5 cm / 6"



23-0070-01
Sharp



23-0070-02
8 x 8 mm
Sharp



23-0070-03
7 x 11 mm
Sharp



23-0080-01
Blunt



23-0080-02
8 x 8 mm
Blunt



23-0080-03
7 x 11 mm
Blunt

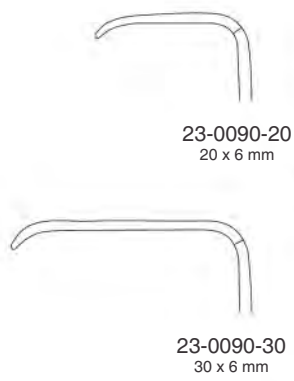

Mannerfelt
 15.5 cm / 6"

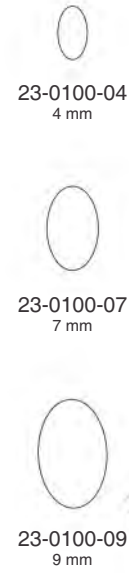

Mannerfelt
 15.5 cm / 6"



Mannerfelt
 12 x 12 mm
 23-0110-12
 15.5 cm / 6"

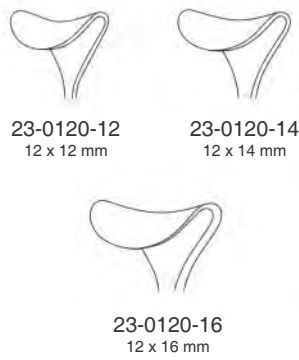

Mannerfelt
 15.5 cm / 6"



Mannerfelt
 23-0130-02
 16 cm / 6¼"

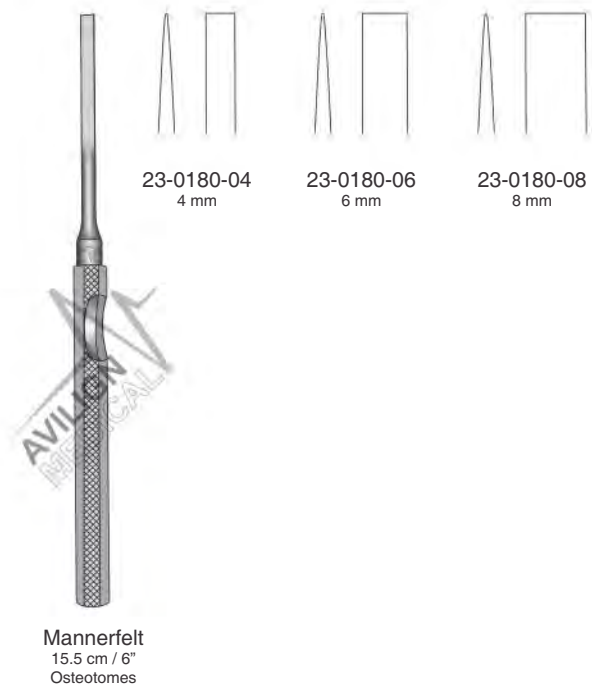
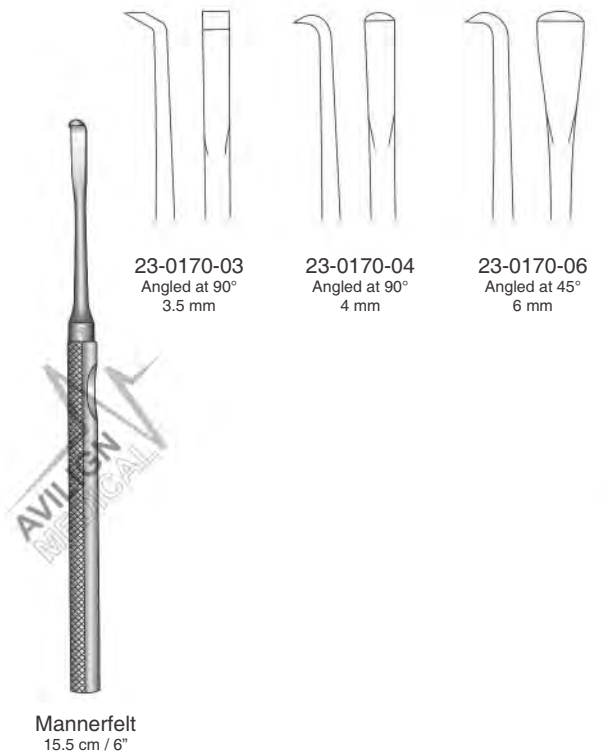
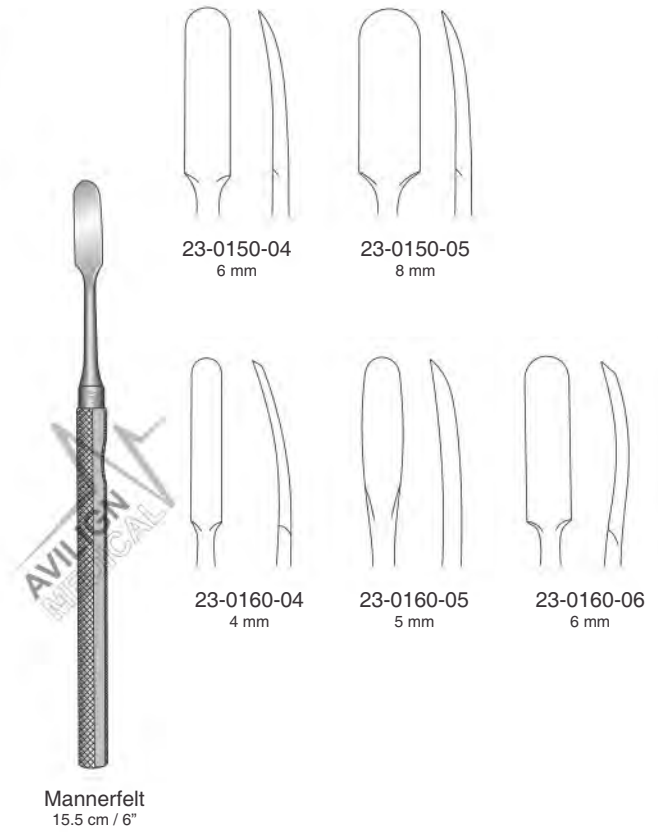
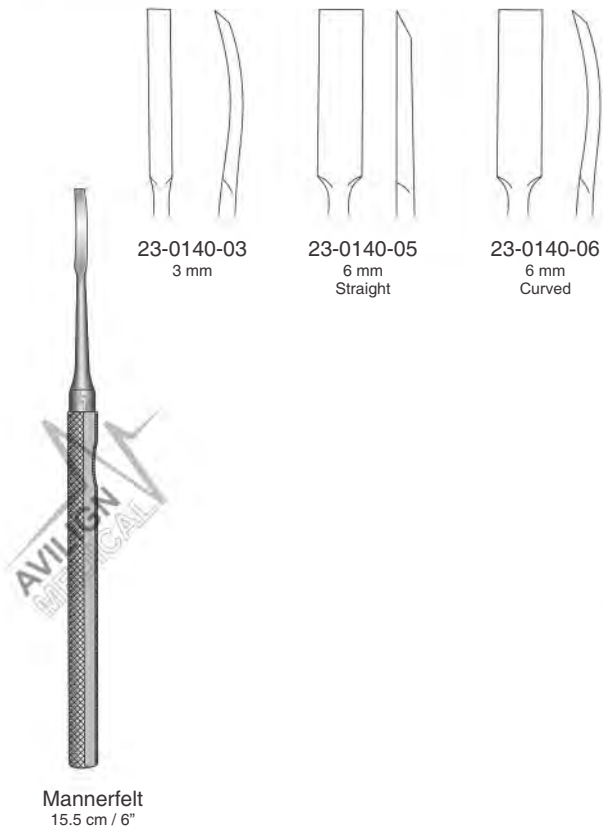

24

Plaster
Dressing Instruments

Gips- ubd Verbandinstrumente
Instrumentos para vendajes y yeso
Strumenti per brndaggi e gessature

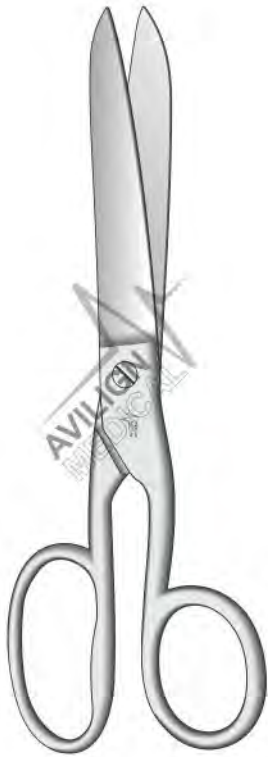

Smith
24-0010-20 20 cm / 8"
24-0010-23 23 cm / 9"

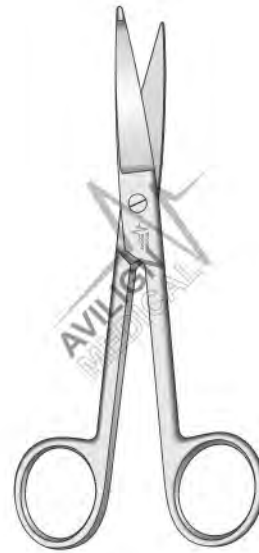

Knowles
24-0020-14
14 cm / 5½"



Lister
24-0030-09 9 cm / 3½"
24-0030-11 11 cm / 3¾"
24-0030-14 14 cm / 5½"
24-0030-16 16 cm / 6¼"
24-0030-18 18 cm / 7"
24-0030-20 20 cm / 8"

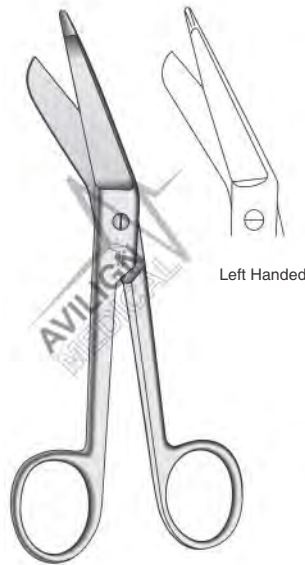

Lister
24-0040-14 14 cm / 5½"
24-0040-18 18 cm / 7"
24-0040-20 20 cm / 8"

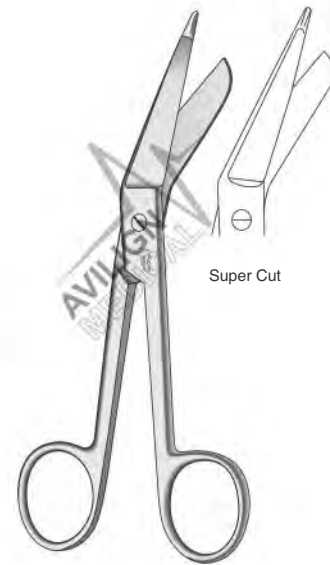

Lister
24-0050-14 14 cm / 5½"
24-0050-18 18 cm / 7"
24-0050-20 20 cm / 8"

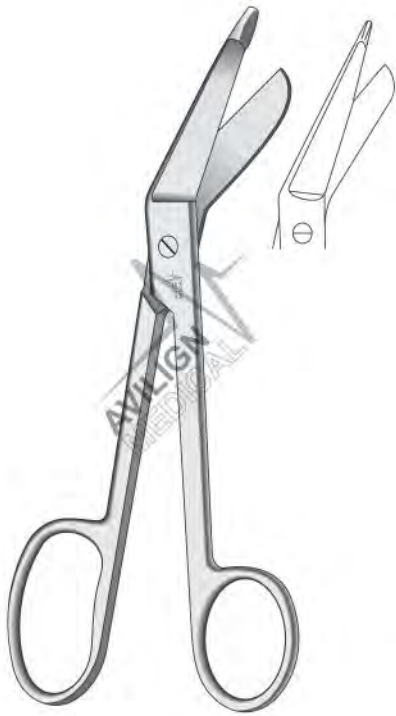

Lister
 24-0060-18 18 cm / 7"
 24-0060-20 20 cm / 8"

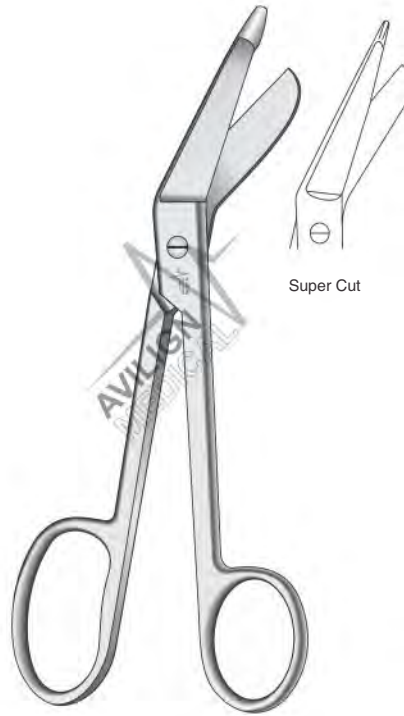

Lister
 24-0070-20
 20 cm / 8"

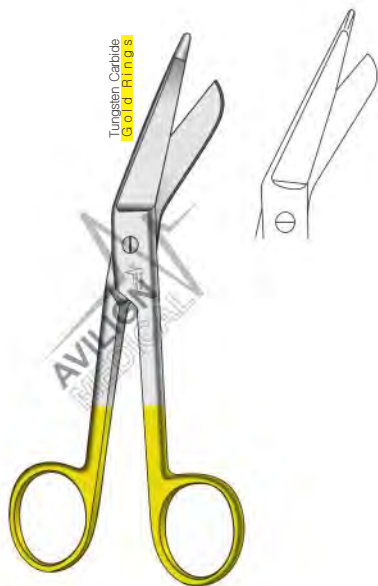

Lister
 24-0080-14 14 cm / 5½"
 24-0080-18 18 cm / 7"
 24-0080-20 20 cm / 8"

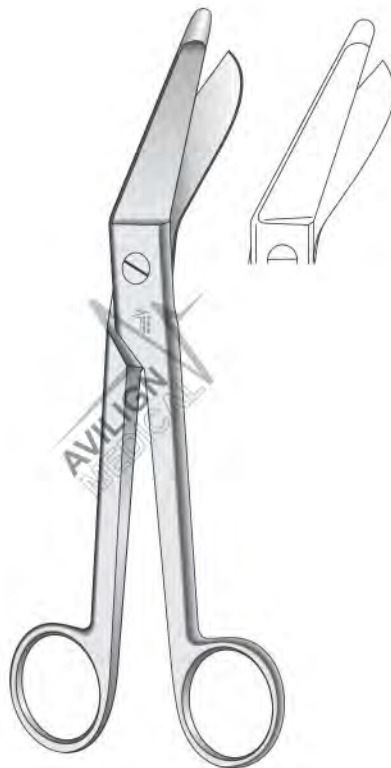

Esmarch
 24-0090-20 20 cm / 8"
 24-0090-23 23 cm / 9"

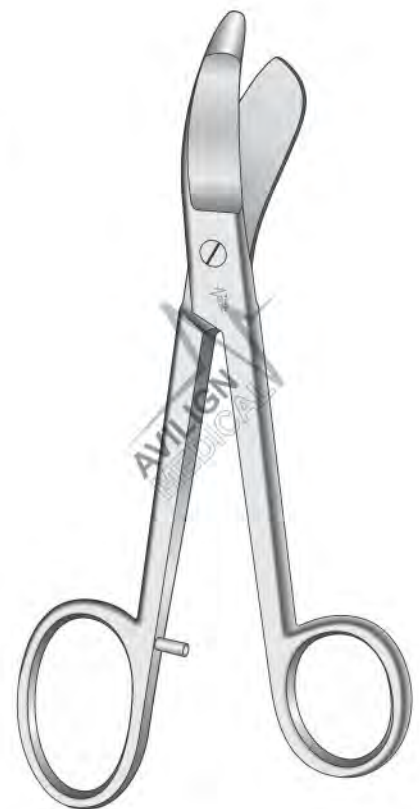

Bruns
 24-0100-24
 24 cm / 9¼"
 One Blade Serrated



Universal
One Blade Serrated



24-0110-15 15 cm / 6"
24-0110-18 18 cm / 7"
Black



24-0120-15 15 cm / 6"
24-0120-18 18 cm / 7"
Green



24-0130-15 15 cm / 6"
24-0130-18 18 cm / 7"
Blue



24-0140-15 15 cm / 6"
24-0140-18 18 cm / 7"
Pink



24-0150-15 15 cm / 6"
24-0150-18 18 cm / 7"
Red



24-0160-15 15 cm / 6"
24-0160-18 18 cm / 7"
Orange



24-0170-15 15 cm / 6"
24-0170-18 18 cm / 7"
Yellow

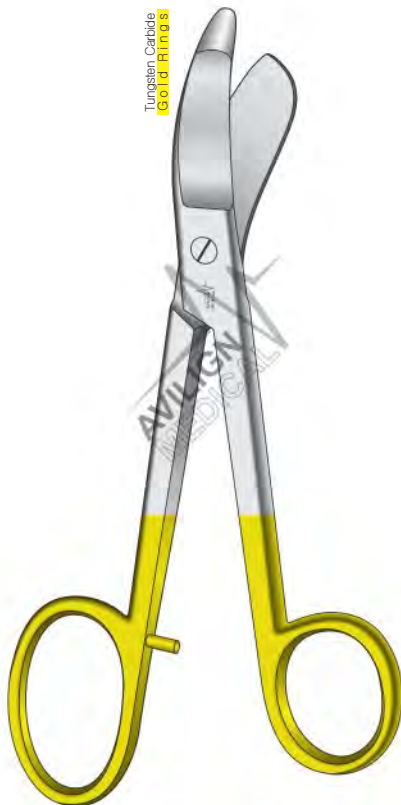

Tungsten Carbide
Gold Rinofs

Bruns
24-0180-23
23 cm / 9"



24-0190-20
20 cm / 8"
One Blade Serrated

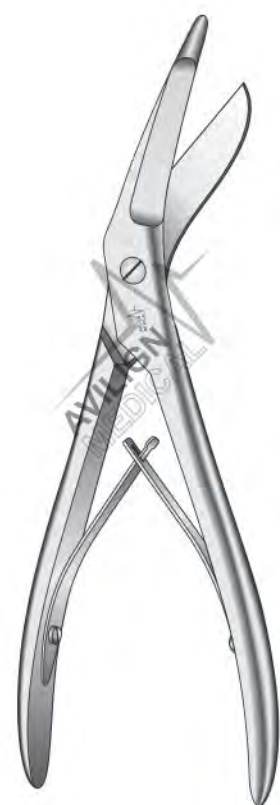

Seutin
24-0200-23
23 cm / 9"

Gipsscheren, Gipsspreizer
Cizallas Para Escayolas, Separadores Para Escayolas
Forbici Per Gessi, Apri Gesso
Plaster of Paris Scissors, Plaster Spreaders



Stille
24-0210-20 20 cm / 8"
24-0210-23 23 cm / 9"
24-0210-26 26 cm / 10¼"
24-0210-37 37 cm / 14½"



Hennig
24-0220-28
28 cm / 11"

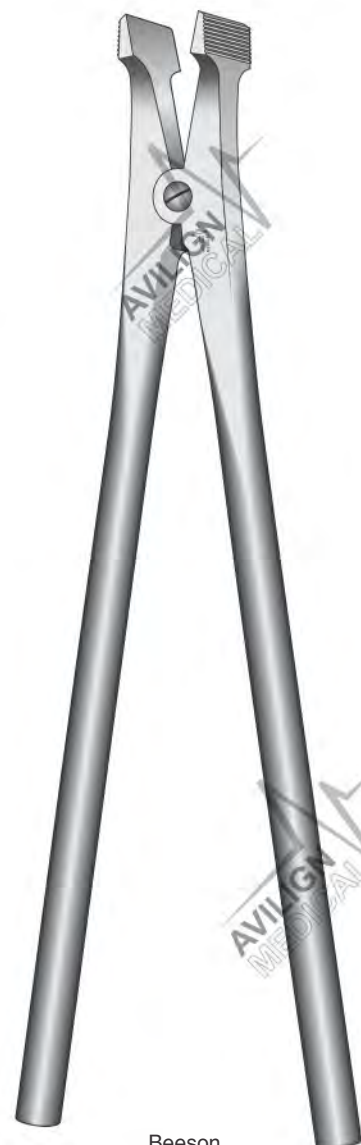

Beeson
24-0230-30
30 cm / 11¼"



Wolff
 24-0240-18 18 cm / 7"
 24-0240-24 24 cm / 9½"



Engel
 24-0250-14
 14 cm / 4½"



Bergmann
 24-0260-18
 18 cm / 7"



Wigmore
 24-0270-19
 19 cm / 7½"



25

Ward Instruments

Stationsinstrumente
Instrumentos para enfermería
Strumenti per medicazione



25-0010-15
15 cm / 6"

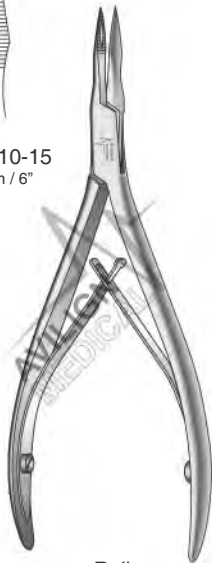

Ralk



25-0020-13
Straight

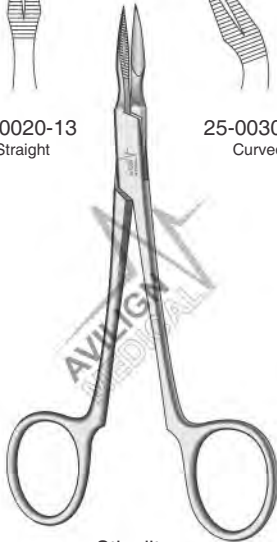

Stieglitz
13 cm / 5"

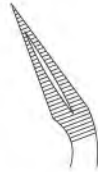

25-0030-13
Curved

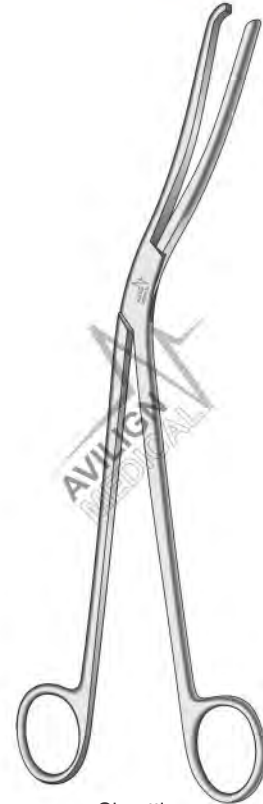

Cheattle
25-0040-28
28 cm / 11"

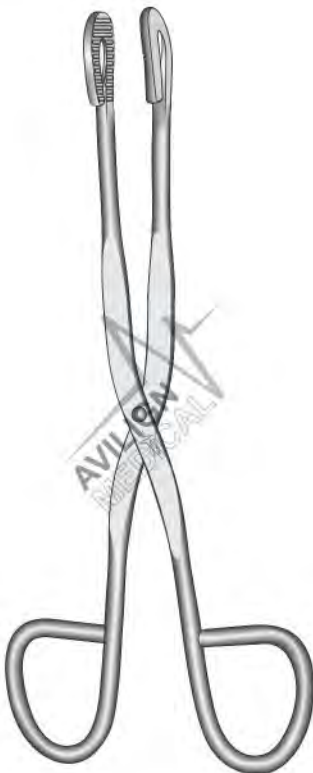

Universal

25-0050-20 20 cm / 8"
25-0050-30 30 cm / 11¼"

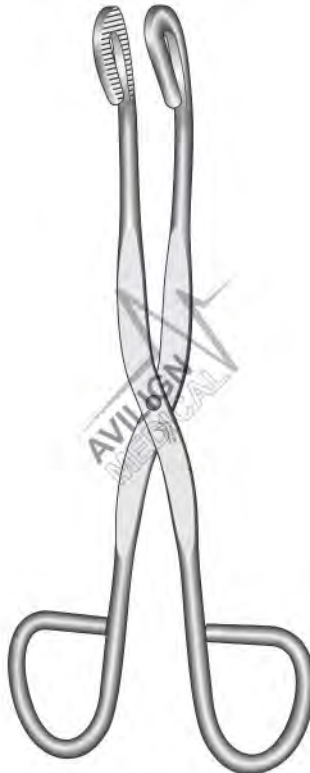

Universal

25-0060-20 20 cm / 8"
25-0060-30 30 cm / 11¼"



Universal

25-0070-20 20 cm / 8"
25-0070-30 30 cm / 11¼"



Stainless Steel, Holloware
26
Behälter, Gefäße
Recipientes
Recipienti



Kidney Dishes

26-0010-17	170 x 100 x 35 mm
26-0010-25	250 x 140 x 40 mm
26-0010-27	270 x 150 x 45 mm



Round Bowls

26-0020-14	140 x 55 mm	0.50
26-0020-15	150 x 75 mm	0.75
26-0020-16	160 x 75 mm	1.00
26-0020-20	220 x 75 mm	2.00
26-0020-22	225 x 90 mm	2.50
26-0020-24	240 x 95 mm	3.00
26-0020-25	255 x 115 mm	3.50
26-0020-26	260 x 120 mm	4.50
26-0020-29	290 x 125 mm	6.00
26-0020-30	300 x 115 mm	6.00
26-0020-32	320 x 140 mm	8.50
26-0020-38	380 x 130 mm	11.00
26-0020-40	400 x 155 mm	14.00



Round Bowls

26-0030-04	Ø 40 x 19 mm	0.05
26-0030-06	Ø 61 x 30 mm	0.07
26-0030-08	Ø 80 x 40 mm	0.14
26-0030-11	Ø 116 x 50 mm	0.35
26-0030-12	Ø 128 x 55 mm	0.45
26-0030-14	Ø 147 x 65 mm	0.70
26-0030-21	Ø 210 x 90 mm	2.50



Round Bowls

26-0040-11	Ø 116 x 35 mm	0.30
26-0040-12	Ø 128 x 38 mm	0.40
26-0040-14	Ø 147 x 40 mm	0.50
26-0040-15	Ø 157 x 45 mm	0.75
26-0040-18	Ø 187 x 45 mm	1.00



Solution Bowls

26-0050-05	Ø 50 x 45 mm	0.05
26-0050-06	Ø 60 x 52 mm	0.07



Jars

26-0060-01	Ø 30 x 90 mm
26-0060-02	Ø 50 x 100 mm
26-0060-03	Ø 50 x 130 mm
26-0060-04	Ø 50 x 175 mm
26-0060-05	Ø 75 x 100 mm
26-0060-06	Ø 75 x 130 mm
26-0060-07	Ø 75 x 175 mm
26-0060-08	Ø 85 x 175 mm
26-0060-09	Ø 95 x 200 mm



Bed Pans
 26-0070-00 Ø 310 x 80 mm
 26-0070-01 Ø 230 x 70 mm



Medicine Cup
 26-0080-00
 50 x 25 mm
 25 ml
 Graduated Inside



Measuring Cup
 26-0090-03 0.25
 26-0090-04 0.50
 26-0090-05 1.00
 26-0090-06 2.00
 Graduated inside



Instrument Trays
 26-0100-23 230 x 155 x 30 mm
 26-0100-30 300 x 175 x 30 mm
 26-0100-31 300 x 175 x 40 mm
 26-0100-35 350 x 240 x 40 mm
 26-0100-40 400 x 300 x 50 mm



Instrument Trays
 26-0110-23
 235 x 190 x 40 mm



Urinal
26-0120-01
220 x 140 mm
Female



Instrument Trays

26-0130-01	210 x 160 x 10 mm
26-0130-02	240 x 180 x 10 mm
26-0130-03	310 x 150 x 10 mm
26-0130-04	310 x 210 x 10 mm
26-0130-05	350 x 240 x 10 mm
26-0130-06	400 x 270 x 20 mm
26-0130-07	420 x 280 x 10 mm



Instrument Boxes

26-0140-01	100 x 60 x 40 mm
26-0140-02	120 x 80 x 40 mm
26-0140-03	160 x 100 x 30 mm
26-0140-04	180 x 120 x 50 mm
26-0140-05	200 x 100 x 50 mm
26-0140-06	220 x 150 x 50 mm
26-0140-07	260 x 150 x 50 mm
26-0140-08	300 x 200 x 50 mm
26-0140-09	400 x 200 x 80 mm
26-0140-10	500 x 270 x 70 mm



Instrument Boxes

26-0150-01	170 x 90 x 35 mm
26-0150-02	200 x 100 x 50 mm
26-0150-03	220 x 150 x 50 mm
26-0150-04	260 x 150 x 50 mm
26-0150-05	310 x 210 x 50 mm

Abfallzangen
Pinzas para desechos
Pinze per rifiuti
Waste Forceps

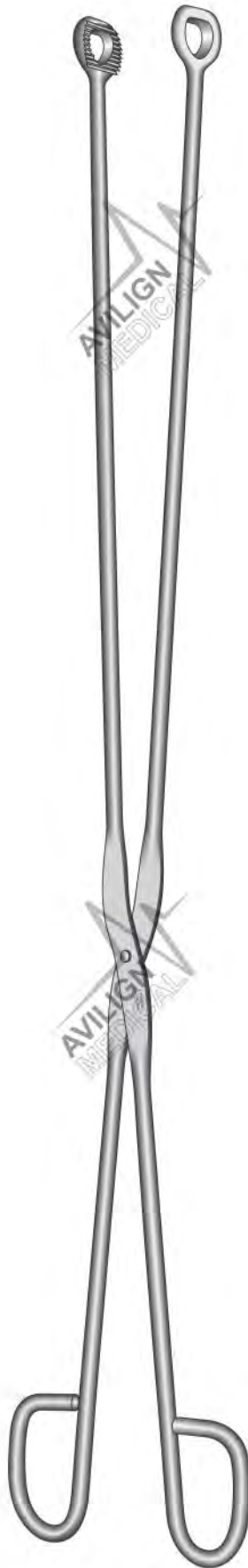

26-0160-58
58 cm / 22³/₄"



26-0170-00
Ø 65 x 15 mm
Complete With Perforated Inner Box



26-0180-65
Ø 62 x 13 mm
Inner Box, Only



26-0190-02
150 x 95 x 13 mm



Sauerbruch
26-0200-00
210 x 125 x 17 mm

26-0210-08	Ø 125 x 80 mm
26-0210-10	Ø 125 x 100 mm
26-0210-12	Ø 125 x 125 mm
26-0220-08	Ø 150 x 80 mm
26-0220-10	Ø 150 x 100 mm
26-0220-13	Ø 150 x 130 mm
26-0220-15	Ø 150 x 150 mm
26-0220-19	Ø 150 x 190 mm
26-0230-14	Ø 190 x 145 mm
26-0230-16	Ø 190 x 165 mm
26-0230-19	Ø 190 x 190 mm
26-0230-24	Ø 190 x 240 mm
26-0240-14	Ø 240 x 145 mm
26-0240-16	Ø 240 x 165 mm
26-0240-19	Ø 240 x 190 mm
26-0240-24	Ø 240 x 240 mm
26-0240-29	Ø 240 x 290 mm
26-0240-34	Ø 240 x 340 mm
26-0240-39	Ø 240 x 390 mm

26-0250-14	Ø 290 x 145 mm
26-0250-16	Ø 290 x 165 mm
26-0250-19	Ø 290 x 190 mm
26-0250-24	Ø 290 x 240 mm
26-0250-29	Ø 290 x 290 mm
26-0250-34	Ø 290 x 340 mm
26-0250-39	Ø 290 x 390 mm
26-0260-14	Ø 340 x 145 mm
26-0260-16	Ø 340 x 165 mm
26-0260-19	Ø 340 x 190 mm
26-0260-24	Ø 340 x 240 mm
26-0260-29	Ø 340 x 290 mm
26-0260-34	Ø 340 x 340 mm
26-0260-39	Ø 340 x 390 mm
26-0270-14	Ø 390 x 145 mm
26-0270-16	Ø 390 x 165 mm
26-0270-19	Ø 390 x 190 mm
26-0270-24	Ø 390 x 240 mm
26-0270-29	Ø 390 x 290 mm
26-0270-34	Ø 390 x 340 mm
26-0270-39	Ø 390 x 390 mm
26-0270-49	Ø 390 x 490 mm
26-0270-59	Ø 390 x 590 mm



Schimmelbusch

26-0280-08	Ø 125 x 80 mm
26-0280-10	Ø 125 x 100 mm
26-0280-12	Ø 125 x 125 mm
26-0290-08	Ø 150 x 80 mm
26-0290-10	Ø 150 x 100 mm
26-0290-13	Ø 150 x 130 mm
26-0290-15	Ø 150 x 150 mm
26-0290-19	Ø 150 x 190 mm
26-0300-14	Ø 190 x 145 mm
26-0300-16	Ø 190 x 165 mm
26-0300-19	Ø 190 x 190 mm
26-0300-24	Ø 190 x 240 mm
26-0310-14	Ø 240 x 145 mm
26-0310-16	Ø 240 x 165 mm
26-0310-19	Ø 240 x 190 mm
26-0310-24	Ø 240 x 240 mm
26-0310-29	Ø 240 x 290 mm
26-0310-34	Ø 240 x 340 mm
26-0310-39	Ø 240 x 390 mm

26-0320-14	Ø 290 x 145 mm
26-0320-16	Ø 290 x 165 mm
26-0320-19	Ø 290 x 190 mm
26-0320-24	Ø 290 x 240 mm
26-0320-29	Ø 290 x 290 mm
26-0320-34	Ø 290 x 340 mm
26-0320-39	Ø 290 x 390 mm
26-0330-14	Ø 340 x 145 mm
26-0330-16	Ø 340 x 165 mm
26-0330-19	Ø 340 x 190 mm
26-0330-24	Ø 340 x 240 mm
26-0330-29	Ø 340 x 290 mm
26-0330-34	Ø 340 x 340 mm
26-0330-39	Ø 340 x 390 mm
26-0340-14	Ø 390 x 145 mm
26-0340-16	Ø 390 x 165 mm
26-0340-19	Ø 390 x 190 mm
26-0340-24	Ø 390 x 240 mm
26-0340-29	Ø 390 x 290 mm
26-0340-34	Ø 390 x 340 mm
26-0340-39	Ø 390 x 390 mm
26-0340-49	Ø 390 x 490 mm
26-0340-59	Ø 390 x 590 mm



Konrich
 Textile Filters Pair



26-0350-25 25 cm / 9¾"
26-0350-32 32 cm / 12½"



26-0360-20 200 x 100 x 25 mm
26-0360-23 230 x 130 x 25 mm
26-0360-27 275 x 230 x 25 mm



56A, Small Industrial Estate
Sialkot, Pakistan.

Phone : +92 52 3258334
Fax : +92 52 3555108
Email : salman@avilignmed.com
Website : www.avilignmed.com